

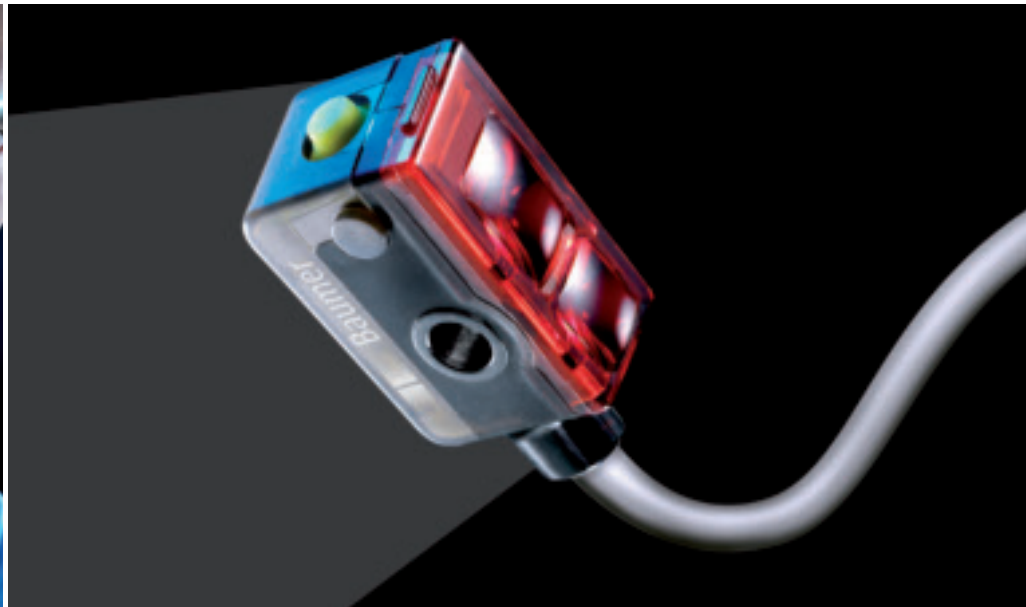

Precise, measurably better. Photoelectric sensors.
Fiber optics and fiber optic sensors. Vision sensors.



Sensor Solutions
Motion Control
Vision Technologies



No newspaper, no chocolate, no car, no computer, no cell phone could be manufactured today, no letters or parcels would reach their recipients and no bottle of beer could be filled if optical sensors could not detect parts, measure distances, determine colors, count components and detect levels.

State of the art:

Modern technology makes it possible to build compact photoelectric sensors with which objects can be detected reliably and precisely even in rough, industrial environments.

Even easy set up smart vision sensors are capable of solving applications in a 2-dimensional area.

Photoelectric sensors from Baumer:

Baumer provides a large range of photoelectric sensors for many different applications.

- Light barriers and diffuse types and such as with background suppression, available also in the smallest versions on the market
- Almost every sensor is available with visible laser light, even the small ones
- Large range of fiber optic sensors and fibers
- Distance measuring laser sensors with high resolution down to 2 μm and measuring distance up to 1 m provide absolute distance information
- Fully contained line sensors for webcontrol or to detect parts in a 2-dimensional area or providing an absolute distance information
- Compact vision sensors for position control, control of completeness and control of part presence
- Sensors for special applications such as the laser copy counter *SCATEC*

Special custom solutions are available for OEM requirements.

In almost every automation process photoelectric sensors play an essential role.

Baumer is the right partner to provide you with competitive and effective solutions for your photoelectric sensing needs.

Please ask us!

Introduction

| | |
|---------------------|-----------------|
| <i>Introduction</i> | <i>Page 198</i> |
|---------------------|-----------------|

Distance and intensity-based

| | |
|--|-----------------|
| <i>Distance sensors</i> | <i>Page 208</i> |
| <i>Difference sensors</i> | <i>Page 232</i> |
| <i>Diffuse sensors with background suppression</i> | <i>Page 242</i> |
| <i>Diffuse sensors with foreground suppression</i> | <i>Page 284</i> |
| <i>Diffuse sensors with intensity difference</i> | <i>Page 298</i> |
| <i>Level monitoring and leak detecting sensors</i> | <i>Page 340</i> |

Light barriers

| | |
|---------------------------------|-----------------|
| <i>Retro-reflective sensors</i> | <i>Page 354</i> |
| <i>Through beam sensors</i> | <i>Page 388</i> |
| <i>Fork and angle sensors</i> | <i>Page 422</i> |

Fiber optics and fiber optic sensors

| | |
|------------------------------------|-----------------|
| <i>Plastic fiber optic sensors</i> | <i>Page 446</i> |
| <i>Plastic fiber optics</i> | <i>Page 466</i> |
| <i>Glass fiber optic sensors</i> | <i>Page 475</i> |
| <i>Glass fiber optics</i> | <i>Page 482</i> |

Vision sensors, edge / profile recognition

| | |
|--|-----------------|
| <i>VeriSens vision sensors</i> | <i>Page 496</i> |
| <i>ParCon and PosCon line sensors</i> | <i>Page 507</i> |
| <i>SCATEC laser copy counters</i> | <i>Page 518</i> |
| <i>SpiderScan optical detection and measuring light barriers</i> | <i>Page 530</i> |

Color / contrast recognition

| | |
|------------------------------|-----------------|
| <i>LOGIPAL color sensors</i> | <i>Page 540</i> |
| <i>Contrast sensors</i> | <i>Page 546</i> |

Miniature sensors – an enormous part of Baumer's domain!



Miniaturization is an unstoppable trend. Faster processes, better quality and highly integrated machines demand more and more efficient miniaturized sensors.

Our unique miniature sensors have solved many applications where it seemed impossible to detect the object in its position.

No space is too small; no application is too difficult to be solved by a miniature sensor from Baumer.



- FHDK 04: smallest diffuse sensor with background suppression on the market (4x5x45mm)
- The sensor family with the smallest housing and adjustable sensing distance (*MINOS*)
- Smallest laser sensor with adjustable background suppression (OHDK 10)
- Series F10: widest product range with best performance



- Either a Teach-in facility or an adjusting button, even on the smallest sensor, makes it possible to adjust the sensor easily and accurately to your application



- Beam size of 0,1 mm to detect very small parts or detect larger objects very precisely independent of any background
- Smallest fully contained distance measuring laser sensor with a resolution down to +/- 2 µm (OADM 12) and measuring distance up to 550mm (OADM 13)

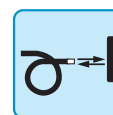

- Large range of plastic and glass fiber optics to solve even the most difficult applications
- Customized fibers
- Broad range of amplifiers: From the easy adjustable to the teachable, high performance one



Laser distance sensor

- Thickness measurement of tablets.

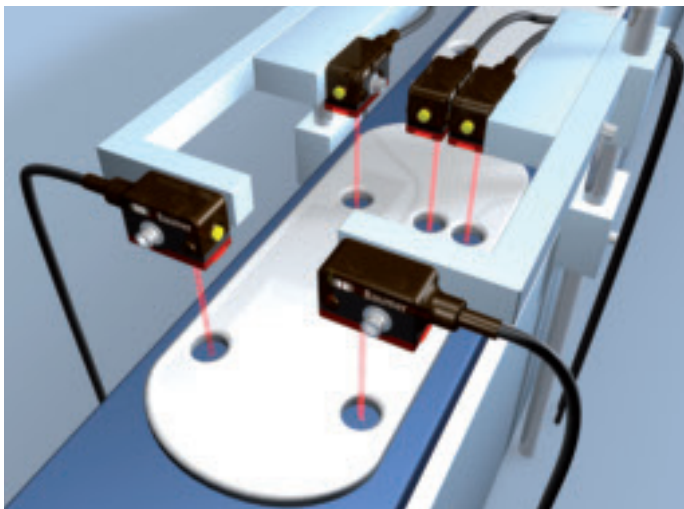
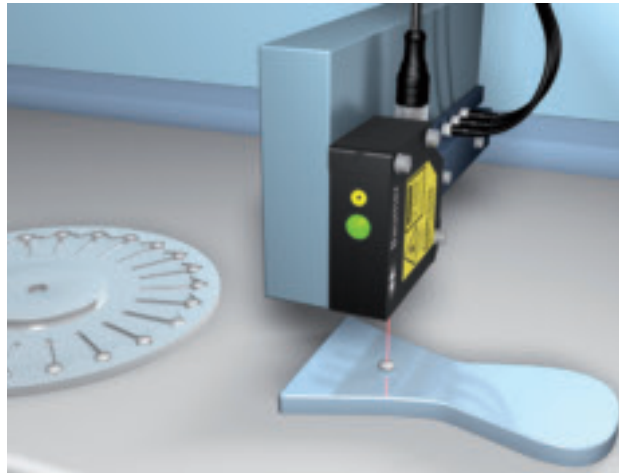

Diffuse sensor with background suppression

- Drill hole inspection.

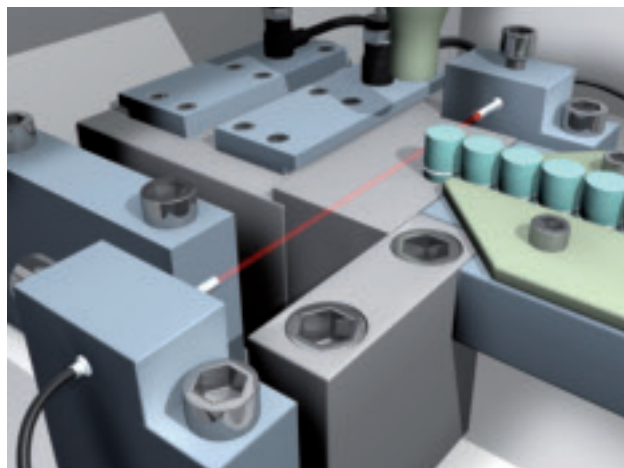

Small fiber optic head

- Detection of small parts in an automatic handling machine.

Distance measuring sensors



In many applications more information is needed than just object presence. Our sensors measure in the micron, millimeter or, depending on the application, in the meter range. They measure distances, width, heights and diameters with great accuracy and are not deterred by difficult surfaces.



- Fully contained CCD line sensors in a compact housing
- *ParCon* measures position or size of an object in a range of 24 mm
- *PosCon* measures the edge of a web in ranges from 50 mm up to 350 mm
- *PosCon* with key pads for simple set-up for your application
- Highest resolution 0,03 mm



- Laser distance measuring sensors are fully contained in compact housings
- Measuring distances from 0,02 m up to 1 m
- Highest resolution $\pm 0,002$ mm
- Shortest response time 0,9 ms
- Teachable measuring ranges for optimized resolution
- Measures distances independent of colors or surfaces



Laser distance sensor (OADM 12)

- Distance measurement on the face of a clock to determine the correct pressing depth of the hands.

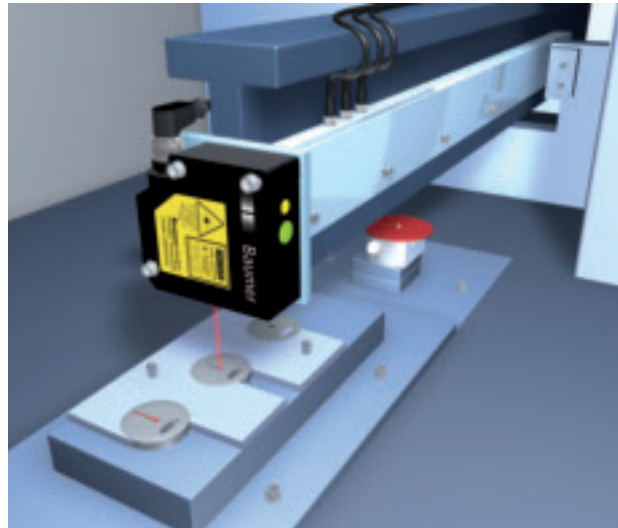

Line sensor (ParCon)

- Inspection of the diameter directly after the extruder.

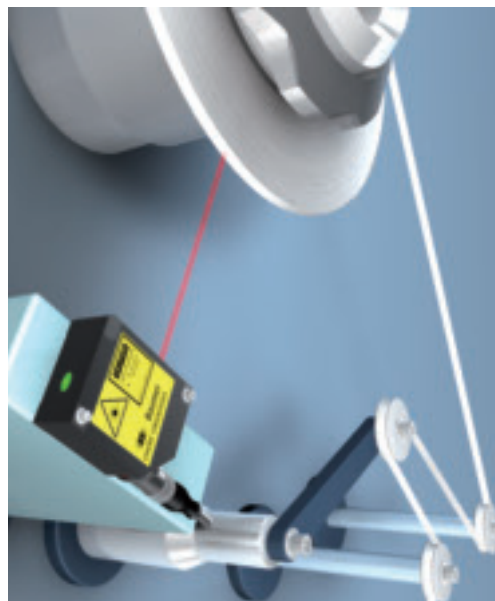

Laser distance sensor (OADM 20)

- Measurement of the quantity remaining on a paper reel.

Laser sensors – fast and accurate!



You want to detect very fine and thin objects? Or should the sensor be guided through a small hole or aperture? The small and energetic laser spot allows large sensing distances with diffuse, through-beam and retro-reflective laser sensors.



- Small, visible light spot
- Laser class 1 or 2
- Laser diodes with a lifetime up to 100'000 hours



- Smallest diffuse laser sensor with adjustable background suppression (OHDM 10)
- Single optic retro-reflective laser sensors
- Smallest, fully contained distance measuring sensor (OADM 12)
- Large range of distance measuring sensors in different housings

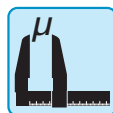

- Fast and precise detection of objects
- High repeatability in detecting and measuring
- Best in class diffuse laser sensor with background suppression (OHDM 12)

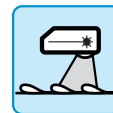

- Laser copy counter (SCATEC) counts up to 3 million copies per hour
- Counting single sheets down to 0,1 mm thickness
- Available with CAN and serial interfaces



Through beam laser sensor (OSDK/OEDK 10 with deflector mirror)

- Position checking of the test tube holder.

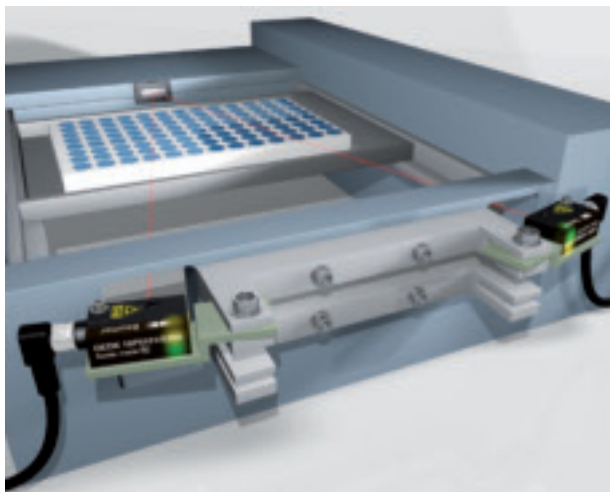

Diffuse sensor (OZDK 10)

- Position checking, detected by the notches.

Difference sensor (OBDM 12)

- Height comparison of the inserted shafts.

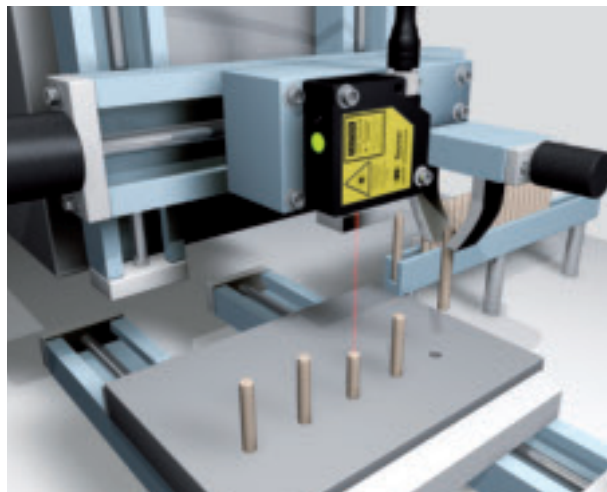

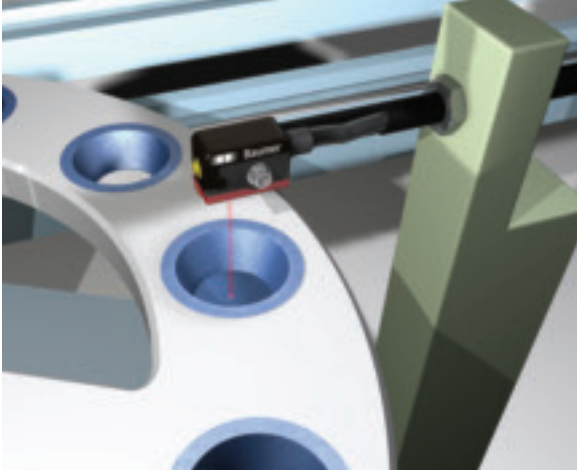

Diffuse sensor (MINOS)

- Placement verification for filter papers.

The Baumer product range has grown consistently through the years. To provide a suitable solution to every measuring problem, the standard range of photoelectric sensors has become almost as diverse as the applications of our customers.

Our diffuse sensors and retro-reflective sensors have proved their value many times in the graphic, semiconductor, textiles, packaging and special machine industries as well as in laboratory automation or electronic manufacturing.

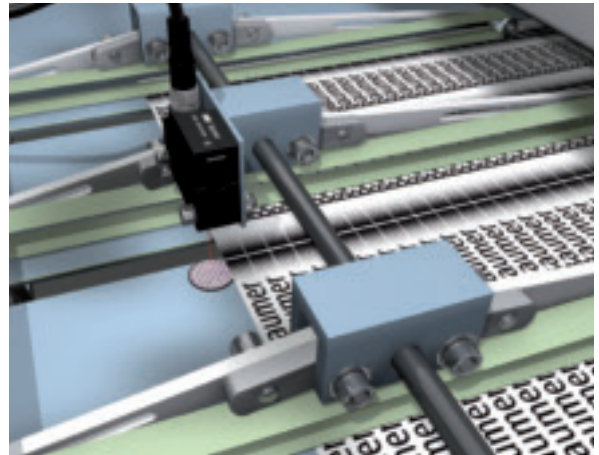

Retro-reflective sensor (FPDK 14)

- Detection of the front edges of paper sheets.

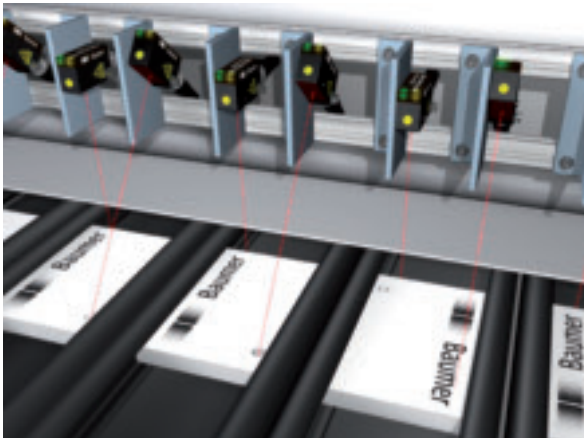

Diffuse sensor with background suppression (FHDK 10)

- Position checking of tablet packages.

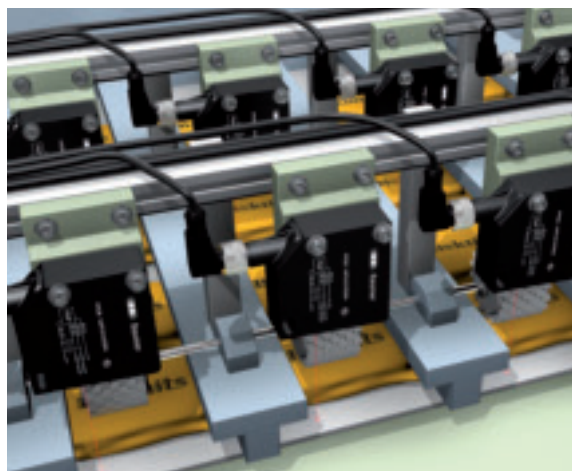

Diffuse sensor with foreground suppression

- Counting biscuit packages on a conveyor belt.

Special requirements demand special solutions



Line sensor (*PosCon*)

- Web edge control of a transparent film.

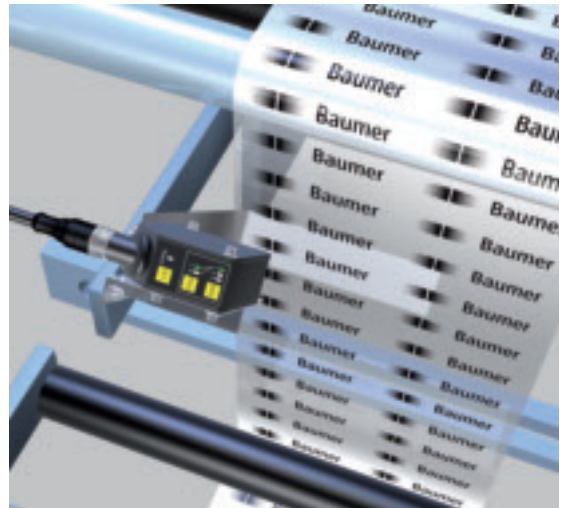

High-power LEDs, laser diodes, CCD receivers, FPGAs, ASICs, SMD, flip-chips – innovative components and technology which we rigorously employ in modern sensors and systems. This makes applications viable which were previously impossible.

Color sensor (*LOGIPAL*)

- Detection of color codes on plugs.

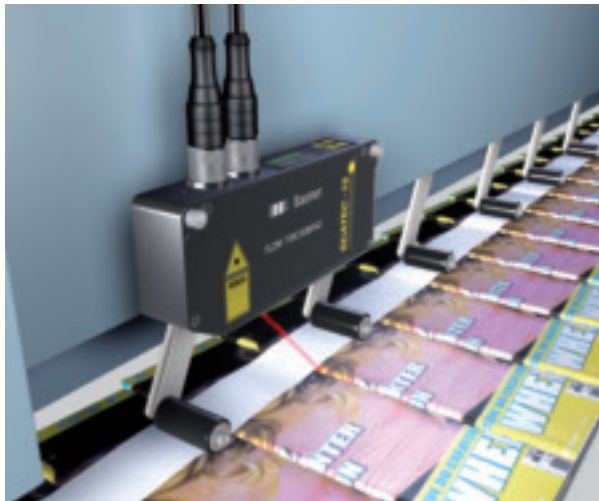

Copy counter (*SCATEC*)

- Counting high-gloss magazines.

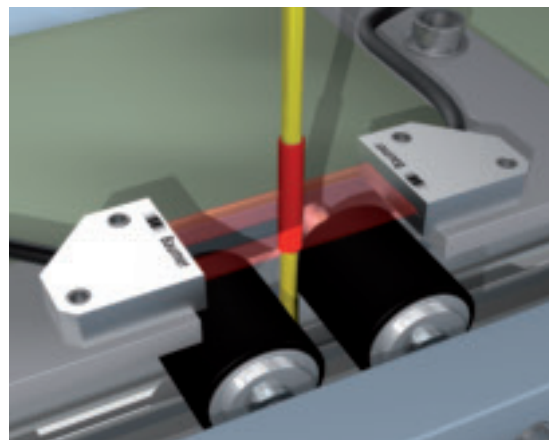

Fiber optic array (*FSE 200C6*)

- Detection of a splice by changes in diameter.

VeriSens® – the vision sensors for automation technology

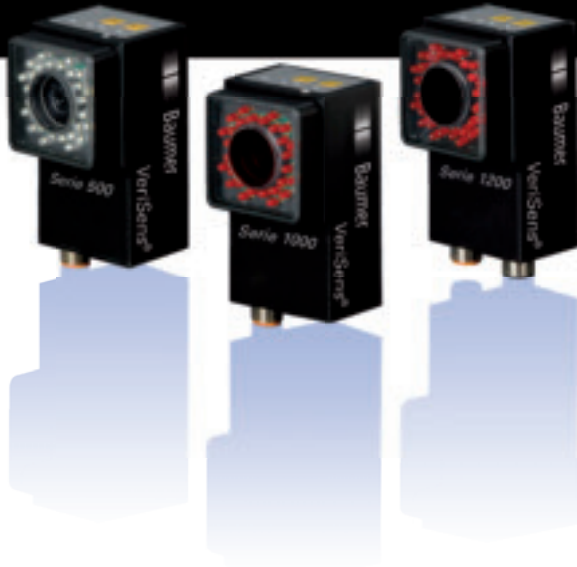

The new image processing vision sensors **VeriSens®** from Baumer closes the gap between traditional optical sensors and complex vision systems. Their high-resolution image sensor permits 2-dimensional inspection of objects. For this purpose **VeriSens®** vision sensors offer comprehensive functions, thus supporting numerous inspection and acquisition tasks in an automated production:

- Control of part completeness
- Control of part presence
- Control / Acquisition of part location
- Control / Acquisition of correct position

Experience the difference!

Special solutions for individual requirements!

No product range will ever be large enough to provide the optimum solution for every application. Occasionally, requirements exist which cannot be satisfied by available market solutions. For this reason, our development engineers cooperate closely with our customers. In our search for the optimum solution for specific requirements, customer-specific sensors are constantly being created.

Special solutions span from special mechanical shapes to completely new sensor systems. An innovative sensor solution can help you to attain a significant competitive advantage.

We would be happy to advise you!

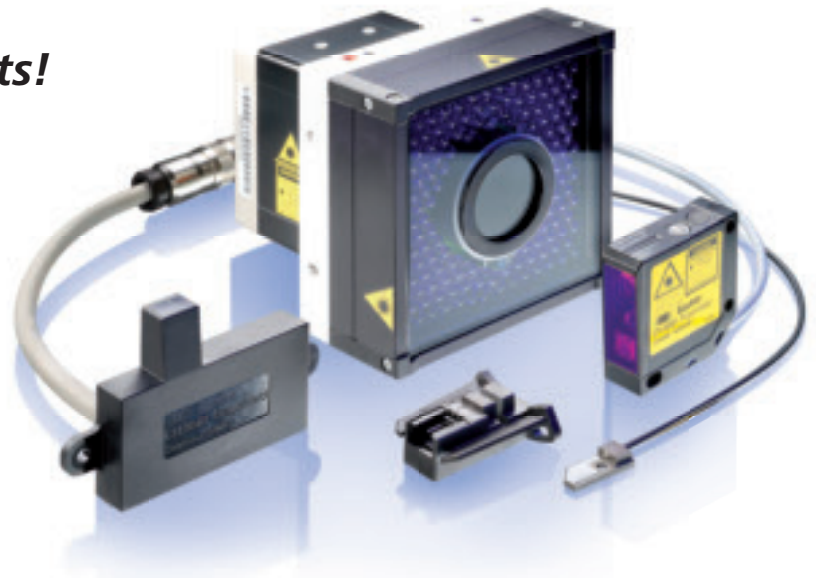



*Distance and
intensity-based*

| product family | OADM 12 | OADM 13 | OADM 13 | OADM 20 | OADM 20 |
|------------------------------|---|---|--|---|---|
| |  |  |  |  |  |
| width / diameter | 12,4 mm | 13,4 mm | 13,4 mm | 20,6 mm | 20,6 mm |
| measuring distance Sd | 16 ... 26 mm 16 ... 120 mm | 50 ... 350 mm 50 ... 550 mm | 50 ... 350 mm 50 ... 550 mm | 30 ... 50 mm 30 ... 130 mm 50 ... 250 mm | 100 ... 500 mm 200 ... 1000 mm |
| resolution | 0,002 ... 0,005 mm 0,002 ... 0,12 mm | 0,01 ... 0,4 mm 0,01 ... 1,1 mm | 0,01 ... 0,4 mm 0,01 ... 1,1 mm | < 0,01 mm < 0,06 mm < 0,3 mm | < 0,5 mm < 3 mm |
| linearity error | ± 0,006 ... ± 0,015 mm ± 0,015 ... ± 0,35 mm | ± 0,05 ... ± 1,2 mm ± 0,08 ... ± 3,5 mm | ± 0,05 ... ± 1,2 mm ± 0,08 ... ± 3,5 mm | ± 0,03 mm ± 0,2 mm ± 0,9 mm | ± 1,5 mm ± 12 mm |
| response time / release time | < 0,9 ms | < 0,9 ms < 1,5 ms | < 0,9 ms < 1,5 ms | < 10 ms | < 10 ms |
| adjustment | Teach-in: button / external | Teach-in: button / external | Teach-in: button / external | no | no |
| output circuit | analog | analog | analog | analog | analog |
| connection types | connector | connector | connector | connector | connector |
| housing material | metal | metal | metal | metal | metal |
| Page | 212 | 214 | 216 | 218 | 220 |

| product family | OADM 20 | OADM 20 | OADM 20 | OADM 20 | OADM 21 |
|------------------------------|---|---|--|---|---|
| |  |  |  |  |  |
| width / diameter | 20,6 mm | 20,6 mm | 20,6 mm | 20,6 mm | 20,4 mm |
| measuring distance Sd | 30 ... 50 mm 30 ... 130 mm 50 ... 250 mm | 100 ... 500 mm 200 ... 1000 mm | 30 ... 70 mm 30 ... 130 mm 50 ... 300 mm | 100 ... 600 mm 200 ... 1000 mm | 200 ... 1000 mm |
| resolution | < 0,01 mm < 0,06 mm < 0,3 mm | < 0,5 mm < 3 mm | 0,004 ... 0,02 mm 0,005 ... 0,06 mm 0,01 ... 0,33 mm | 0,015 ... 0,67 mm 0,12 ... 3 mm | 0,02 ... 0,5 mm |
| linearity error | ± 0,03 mm ± 0,2 mm ± 0,9 mm | ± 1,5 mm ± 12 mm | ± 0,012 ... ± 0,06 mm ± 0,015 ... ± 0,2 mm ± 0,03 ... ± 1 mm | ± 0,05 ... ± 2 mm ± 0,48 ... ± 12 mm | ± 0,08 ... ± 2 mm |
| response time / release time | < 10 ms | < 10 ms | < 0,9 ms | < 0,9 ms < 2,8 ms | < 10 ms |
| adjustment | no | no | Teach-in: button / external | Teach-in: button / external | Teach-in: button / external |
| output circuit | RS 485 | RS 485 | analog | analog | analog |
| connection types | connector | connector | connector | connector | connector |
| housing material | metal | metal | metal | metal | metal |
| Page | 222 | 224 | 226 | 228 | 230 |



General information

OADM is a range of laser distance sensors with products covering the measuring range from 16 to 1000 mm. The compact sensors with integrated microcontrollers produce an accurate output signal proportional to the measured distance. Intelligent internal signal analysis permits the sensor to operate accurately regardless of the color and most surfaces. The sensor can always be easily and precisely aligned with the small, visible spot of light. Distances to rough surfaces can be reliably measured by using a fine laser line in place of the laser spot, so that a wider area is monitored.

Typical applications

This family of sensors, with its wide selection of measuring ranges, can be used in many applications.

Typical applications are:

- Applications in which the production process is continuously monitored by the sensor to detect slow changes at an early stage and thereby achieve a reduction of rejects and costs.
- Automation of test points and test equipment permits increased productivity.
- Automation of format settings permits multifunctional machines and rapid, precise reconfiguration.

In some other applications, objects with rough and uneven surfaces must be measured. Sometimes, the surface of the object even has small holes or gaps. Such objects can be easily measured using a laser line optical system, which supplies a fine laser line in place of a focused laser beam.

Characteristics and advantages

Response time

Measuring cycles as short as 0,9 ms permit accurate measurements even on moving parts.

Integrated microcontroller

The integrated microcontroller makes an external processing device unnecessary and makes it simple to place the sensor wherever it is needed.

High resolution and linearity

By the use of a photodiode line, a very high linearity of ± 0.006 mm is achieved at a resolution of up to 0.002 mm.

Laser spot or laser line

Distances, even to rough surfaces, are reliably measured by using a laser line instead of the laser spot.

Any surface

Intelligent signal processing improves the measurements made on critical surfaces by the photodiode line.

Teach-in function

The measuring range can be adjusted within the maximum measuring range by the user with the Teach-in button or via the Teach-in cable. The analog output has its full span within this taught-in range. The factory setting is the maximum measuring range. The taught-in range has a minimum extent. The resolution and linearity change when the measuring range is changed. The closer the furthest point of the measuring range is to the sensor, the better the resolution.



Characteristics and advantages

Synchronization/hold function

The measurements of several sensors can be synchronized using the synch input, or the last value can be held and the laser diode switched off.

Insensitivity to external light

An algorithm makes the sensor insensitive to external light sources.

Technology and operation

The distance measurement is based on the triangulation principle. The laser beam strikes the object as a small point. The receiver of the sensor (photodiode line) detects the position of this point. The angle of incidence changes according to the distance, and thereby the position of the laser point on the receiver. The photodiode line is read by an integrated microcontroller. The controller accurately calculates the angle from the light distribution on the photodiode line and then calculates the distance to the object from this. This distance is either issued at the serial port or converted into an output current proportional to the distance. The microcontroller guarantees a high degree of linearity and measuring precision. The combination of a photodiode line and a microcontroller permits interfering reflections to be suppressed and thereby provides reliable data from critical surfaces. The sensor adapts to different colors by adjusting its internal sensitivity, making it virtually independent of the color of the object. A digital output is activated if there is no object within the measuring range or if insufficient light is received to correctly detect the object, e.g. if the sensor is dirty. The possible resolution and accuracy change with the distance. The same distance Δd which causes a large change in the angle α_1 close to the sensor produces a much smaller change in the angle α_2 at a greater distance (see drawing). This non-linear behavior is corrected by the microcontroller, so that the output signal remains linear to the distance.

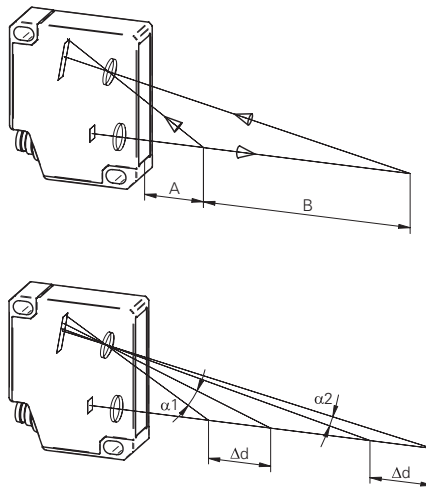



Mounting and adjustment

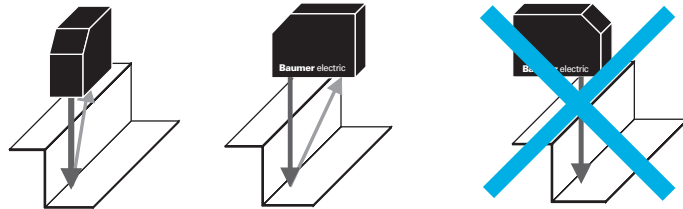

With all triangulation sensors, it must be ensured that the laser spot can be seen directly by the optical system of the receiver and that no obstructions are in front of the receiver.

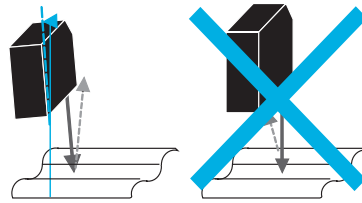

With glossy or reflective objects, the direct reflection must not impinge on the receiver. This can be avoided by slightly tilting the sensor.

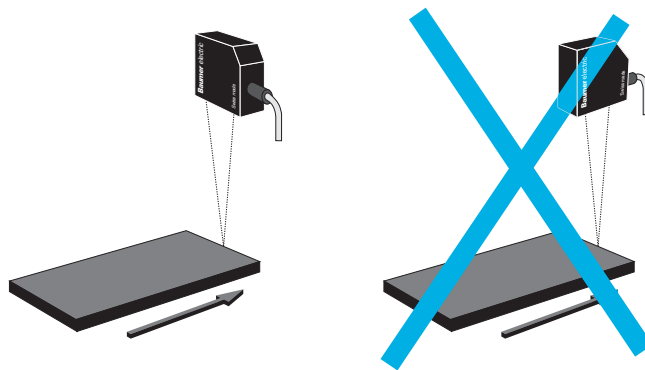

For optimum measurement results, the sensor must be installed perpendicular to the movement of the object.

A simple rule applies that the distance between the sensor and the object should be kept as small as possible for each application. The shorter the range, the better (more than proportional) the resolution and accuracy.

Note on electromagnetic compatibility: ground the sensor and use a shielded connecting cable.

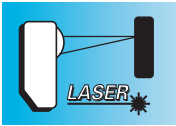

Sd = 16 ... 120 mm

- Pocket-size design
- teachable measuring range
- resolution up to 2 µm



OADM 12 Sd = 16 ... 120 mm

general data

| | |
|--------------------------|-----------------------------|
| sensing element | photoelectric array |
| adjustment | Teach-in: button / external |
| power on indication | LED green |
| soiled lens indicator | LED red / LED red blinking |
| light source | pulsed red laser diode |
| wave length | 675 nm |
| laser class | 2 |
| beam type | point |
| interference suppression | < 30 ms |

measuring distance Sd = 16 ... 26 mm

| | |
|---------------------|------------------------|
| Teach-in range min. | > 1 mm |
| resolution | 0,002 ... 0,005 mm |
| linearity error | ± 0,006 ... ± 0,015 mm |
| beam diameter | 0,5 ... 0,2 mm |

measuring distance Sd = 16 ... 120 mm

| | |
|---------------------|-----------------------|
| Teach-in range min. | > 2 mm |
| resolution | 0,002 ... 0,12 mm |
| linearity error | ± 0,015 ... ± 0,35 mm |
| beam diameter | 0,9 ... 0,5 mm |

electrical data

| | |
|------------------------------|----------------|
| response time / release time | < 0,9 ms |
| voltage supply range +Vs | 12 ... 28 VDC |
| current consumption max. | 100 mA |
| output circuit | analog |
| short circuit protection | yes |
| reverse polarity protection | yes, Vs to GND |

mechanical data

| | |
|------------------|---------------------|
| width / diameter | 12,4 mm |
| height / length | 37 mm |
| depth | 34,5 mm |
| type | rectangular |
| housing material | die-cast zinc |
| front (optics) | glass |
| connection types | connector M8, 4 pin |

ambient conditions

| | |
|-----------------------|--------------|
| operating temperature | 0 ... +50 °C |
| protection class | IP 67 |

connection diagrams

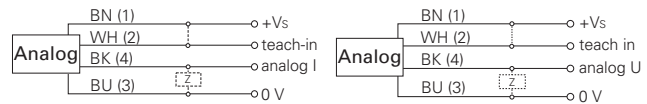

connectors

| | | |
|---------------|-------|-------------------------|
| ESG 32AP0500G | 4 pin | 5 m straight (shielded) |
| ESW 31AP0500G | 4 pin | 5 m angular (shielded) |

additional cable connectors and field wireable connectors, see accessories

accessories

| | |
|-----------------------|--------|
| SENSOFIX mounting kit | 150328 |
| mounting bracket | 113873 |

for details, see accessories section

remarks

For objects with a reflectivity < 4%, the response time / release time is increased automatically up to max. 1,5 ms.
 Missed measurement up to 30 cycles (30 ms) will be suppressed. During this time the analog output stays on hold.

laser warning



Distance sensors

| order reference | measuring distance Sd | output signal | load resistance |
|-------------------|-----------------------|---------------|------------------------|
| OADM 12I6430/S35A | 16 ... 26 mm | 4 ... 20 mA | < (+Vs - 6 V) / 0,02 A |
| OADM 12I6460/S35A | 16 ... 120 mm | 4 ... 20 mA | < (+Vs - 6 V) / 0,02 A |
| OADM 12U6430/S35A | 16 ... 26 mm | 0 ... 10 VDC | > 100 kOhm |
| OADM 12U6460/S35A | 16 ... 120 mm | 0 ... 10 VDC | > 100 kOhm |

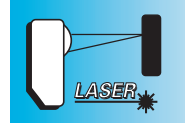

resolution

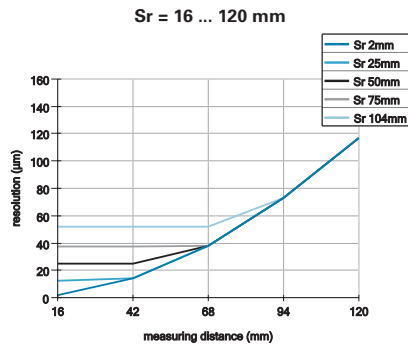
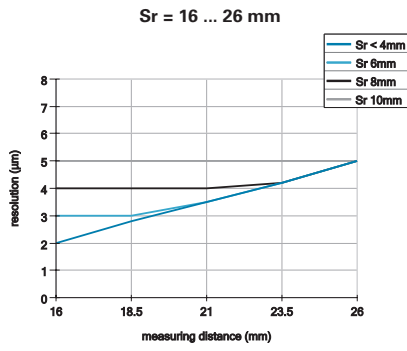

linearity error

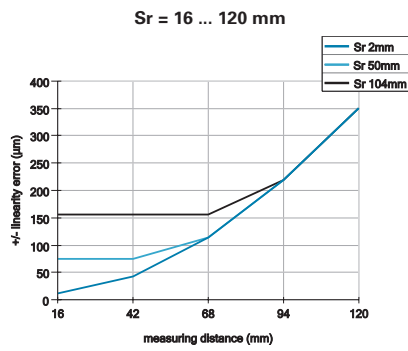
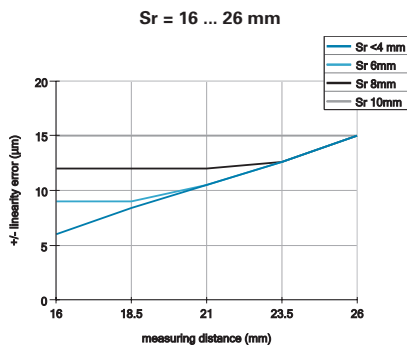

dimension drawing

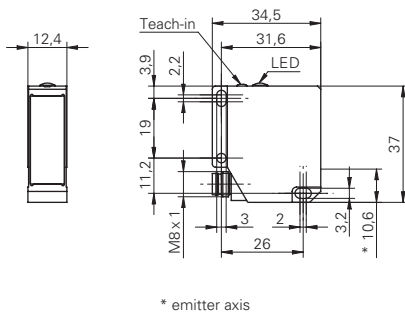

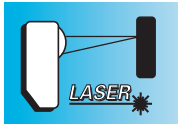

Sd = 50 ... 550 mm



- compact housing, current output
- teachable measuring range
- resolution up to 10 µm

general data

| | |
|--------------------------|-----------------------------|
| sensing element | photoelectric array |
| adjustment | Teach-in: button / external |
| power on indication | LED green |
| soiled lens indicator | LED red / LED red blinking |
| light source | pulsed red laser diode |
| wave length | 675 nm |
| laser class | 2 |
| interference suppression | < 30 ms |

measuring distance Sd = 50 ... 350 mm

| | |
|---------------------|---------------------|
| Teach-in range min. | > 5 mm |
| resolution | 0,01 ... 0,4 mm |
| linearity error | ± 0,05 ... ± 1,2 mm |

measuring distance Sd = 50 ... 550 mm

| | |
|---------------------|---------------------|
| Teach-in range min. | > 10 mm |
| resolution | 0,01 ... 1,1 mm |
| linearity error | ± 0,08 ... ± 3,5 mm |

electrical data

| | |
|-----------------------------|------------------------|
| voltage supply range +Vs | 12 ... 28 VDC |
| current consumption max. | 100 mA |
| output circuit | analog |
| output signal | 4 ... 20 mA |
| load resistance | < (+Vs - 6 V) / 0,02 A |
| short circuit protection | yes |
| reverse polarity protection | yes, Vs to GND |

measuring distance Sd = 50 ... 350 mm

| | |
|------------------------------|----------|
| response time / release time | < 0,9 ms |
|------------------------------|----------|

measuring distance Sd = 50 ... 550 mm

| | |
|------------------------------|----------|
| response time / release time | < 1,5 ms |
|------------------------------|----------|

mechanical data

| | |
|------------------|---------------------|
| width / diameter | 13,4 mm |
| height / length | 48,2 mm |
| depth | 40 mm |
| type | rectangular |
| housing material | aluminum |
| front (optics) | glass |
| connection types | connector M8, 4 pin |

ambient conditions

| | |
|-----------------------|--------------|
| operating temperature | 0 ... +50 °C |
| protection class | IP 67 |

connection diagram

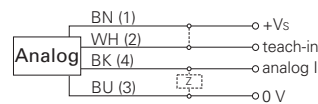

connectors

| | | |
|---------------|-------|-------------------------|
| ESG 32AP0500G | 4 pin | 5 m straight (shielded) |
| ESW 31AP0500G | 4 pin | 5 m angular (shielded) |

additional cable connectors and field wireable connectors, see accessories

accessories

| | |
|-----------------------|--------|
| SENSOFIX mounting kit | 161829 |
| mounting bracket | 161695 |

for details, see accessories section

remarks

For objects with a reflectivity < 10%, the response time / release time is increased automatically up to max. 3 ms (OADM 13x6x75/S35A) resp. 5 ms (OADM 13x6x80/S35A).
 Missed measurement up to 30 cycles (30 ms) will be suppressed. During this time the analog output stays on hold.

laser warning



| order reference | measuring distance Sd | beam type | beam width | beam height | beam diameter |
|-------------------|-----------------------|-----------|------------|-------------|---------------|
| OADM 13I6475/S35A | 50 ... 350 mm | point | - | - | 1 mm |
| OADM 13I6480/S35A | 50 ... 550 mm | point | - | - | 1 mm |
| OADM 13I6575/S35A | 50 ... 350 mm | line | 2 mm | 4 ... 9 mm | - |
| OADM 13I6580/S35A | 50 ... 550 mm | line | 2 mm | 4 ... 13 mm | - |

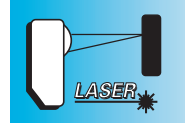

resolution

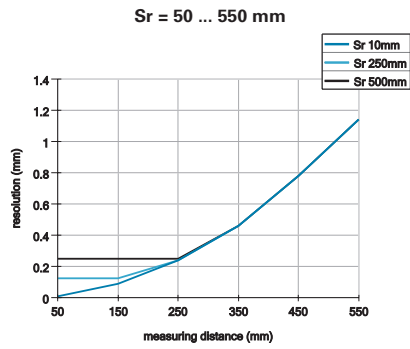
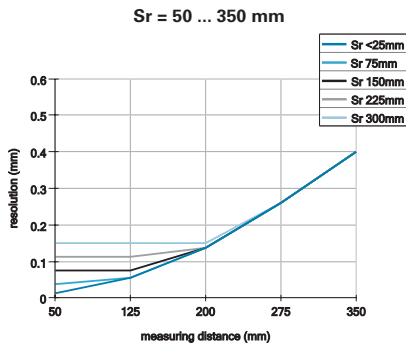

linearity error

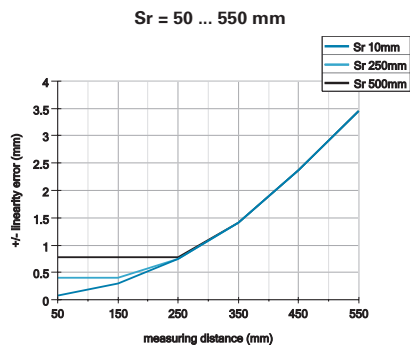
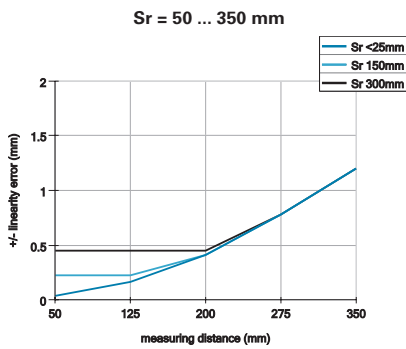

beam alignment (line)

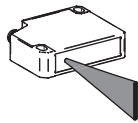

dimension drawing

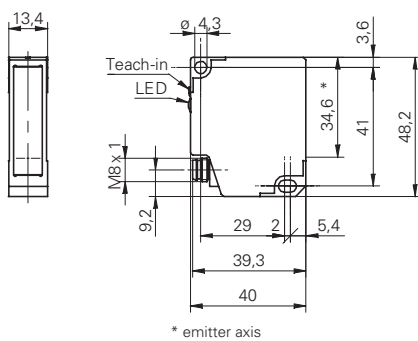

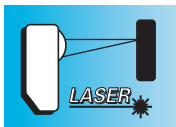

Sd = 50 ... 550 mm

- compact housing, voltage output
- teachable measuring range
- resolution up to 10 µm

**general data**

| | |
|--------------------------|-----------------------------|
| sensing element | photoelectric array |
| adjustment | Teach-in: button / external |
| power on indication | LED green |
| soiled lens indicator | LED red / LED red blinking |
| light source | pulsed red laser diode |
| wave length | 675 nm |
| laser class | 2 |
| interference suppression | < 30 ms |

measuring distance Sd = 50 ... 350 mm

| | |
|---------------------|---------------------|
| Teach-in range min. | > 5 mm |
| resolution | 0,01 ... 0,4 mm |
| linearity error | ± 0,05 ... ± 1,2 mm |

measuring distance Sd = 50 ... 550 mm

| | |
|---------------------|---------------------|
| Teach-in range min. | > 10 mm |
| resolution | 0,01 ... 1,1 mm |
| linearity error | ± 0,08 ... ± 3,5 mm |

electrical data

| | |
|-----------------------------|----------------|
| voltage supply range +Vs | 12 ... 28 VDC |
| current consumption max. | 80 mA |
| output circuit | analog |
| output signal | 0 ... 10 VDC |
| load resistance | > 100 kOhm |
| short circuit protection | yes |
| reverse polarity protection | yes, Vs to GND |

measuring distance Sd = 50 ... 350 mm

| | |
|------------------------------|----------|
| response time / release time | < 0,9 ms |
|------------------------------|----------|

measuring distance Sd = 50 ... 550 mm

| | |
|------------------------------|----------|
| response time / release time | < 1,5 ms |
|------------------------------|----------|

mechanical data

| | |
|------------------|---------------------|
| width / diameter | 13,4 mm |
| height / length | 48,2 mm |
| depth | 40 mm |
| type | rectangular |
| housing material | aluminum |
| front (optics) | glass |
| connection types | connector M8, 4 pin |

ambient conditions

| | |
|-----------------------|--------------|
| operating temperature | 0 ... +50 °C |
| protection class | IP 67 |

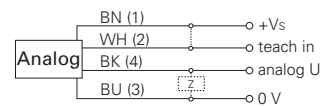
connection diagram**connectors**

| | | |
|---------------|-------|-------------------------|
| ESG 32AP0500G | 4 pin | 5 m straight (shielded) |
| ESW 31AP0500G | 4 pin | 5 m angular (shielded) |

additional cable connectors and field wireable connectors, see accessories

accessories

| | |
|-----------------------|--------|
| SENSOFIX mounting kit | 161829 |
| mounting bracket | 161695 |

for details, see accessories section

remarks

For objects with a reflectivity < 10%, the response time / release time is increased automatically up to max. 3 ms (OADM 13x6x75/S35A) resp. 5 ms (OADM 13x6x80/S35A).

Missed measurement up to 30 cycles (30 ms) will be suppressed. During this time the analog output stays on hold.

laser warning

| order reference | measuring distance Sd | beam type | beam width | beam height | beam diameter |
|-------------------|-----------------------|-----------|------------|-------------|---------------|
| OADM 13U6475/S35A | 50 ... 350 mm | point | - | - | 1 mm |
| OADM 13U6480/S35A | 50 ... 550 mm | point | - | - | 1 mm |
| OADM 13U6575/S35A | 50 ... 350 mm | line | 2 mm | 4 ... 9 mm | - |
| OADM 13U6580/S35A | 50 ... 550 mm | line | 2 mm | 4 ... 13 mm | - |

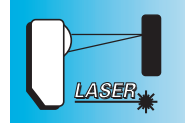

resolution

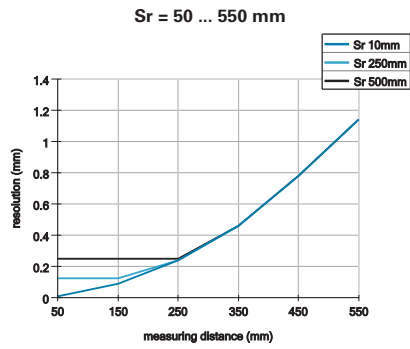
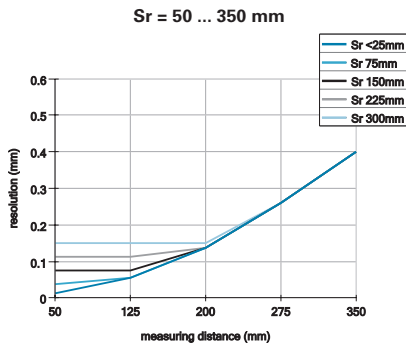

linearity error

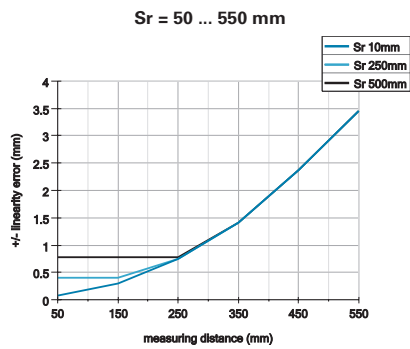
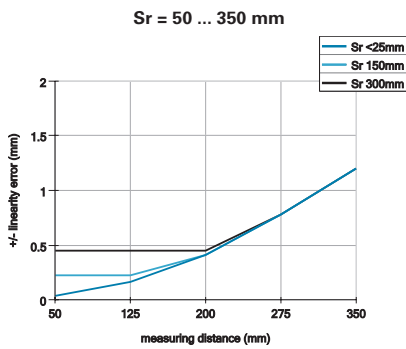

beam alignment (line)

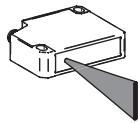

dimension drawing

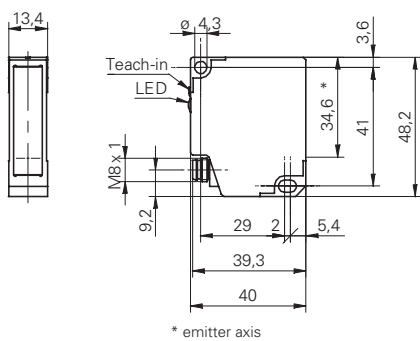

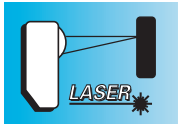

Sd = 30 ... 250 mm

- current or voltage output
- resolution up to 10 µm
- with laser line for rough surfaces



general data

| | |
|-----------------------|----------------------------|
| sensing element | photoelectric array |
| adjustment | no |
| power on indication | LED green |
| soiled lens indicator | LED red / LED red blinking |
| light source | pulsed red laser diode |
| wave length | 675 nm |
| laser class | 2 |

measuring distance Sd = 30 ... 50 mm

| | |
|-----------------|-----------|
| resolution | < 0,01 mm |
| linearity error | ± 0,03 mm |

measuring distance Sd = 30 ... 130 mm

| | |
|-----------------|-----------|
| resolution | < 0,06 mm |
| linearity error | ± 0,2 mm |

measuring distance Sd = 50 ... 250 mm

| | |
|-----------------|----------|
| resolution | < 0,3 mm |
| linearity error | ± 0,9 mm |

electrical data

| | |
|------------------------------|----------------------------|
| response time / release time | < 10 ms |
| voltage supply range +Vs | 12 ... 28 VDC |
| current consumption max. | 120 mA |
| output circuit | analog |
| output signal | 4 ... 20 mA / 0 ... 10 VDC |
| load resistance (analog I) | < (+Vs - 6 V) / 0,02 A |
| load resistance (analog U) | > 100 kOhm |
| output current | < 100 mA |
| alarm output | PNP |
| short circuit protection | yes |
| reverse polarity protection | yes, Vs to GND |

mechanical data

| | |
|------------------|---------------------------------|
| width / diameter | 20,6 mm |
| height / length | 65 mm |
| depth | 50 mm |
| housing material | die-cast zinc |
| front (optics) | glass |
| connection types | connector M12, 5 pin, rotatable |

ambient conditions

| | |
|-----------------------|--------------|
| operating temperature | 0 ... +50 °C |
| protection class | IP 67 |

connection diagram

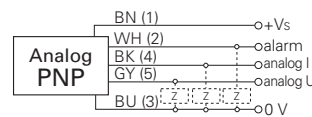

connectors

| | | |
|-----------|-------|-------------------------|
| ES 34CP2B | 5 pin | 2 m straight (shielded) |
|-----------|-------|-------------------------|

additional cable connectors and field wireable connectors, see accessories

accessories

| | |
|------------------|--------|
| mounting bracket | 131521 |
|------------------|--------|

for details, see accessories section

remarks

While switching-on the sensor, it checks if there is a current at current output BK (4). If so, the current output is activated. If not, the voltage output GY (5) is activated after 100 ms.

laser warning

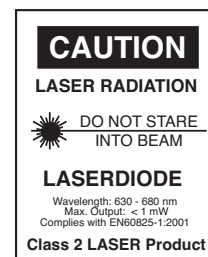

| order reference | measuring distance Sd | beam type | beam width | beam height | beam diameter |
|-------------------|-----------------------|-----------|--------------|-------------|---------------|
| OADM 20I4440/S14C | 30 ... 50 mm | point | - | - | 1 ... 0,4 mm |
| OADM 20I4460/S14C | 30 ... 130 mm | point | - | - | 2 ... 1 mm |
| OADM 20I4470/S14C | 50 ... 250 mm | point | - | - | 2 mm |
| OADM 20I4540/S14C | 30 ... 50 mm | line | 1 ... 0,4 mm | 2 mm | - |
| OADM 20I4560/S14C | 30 ... 130 mm | line | 2 ... 1 mm | 3 ... 5 mm | - |
| OADM 20I4570/S14C | 50 ... 250 mm | line | 2,5 mm | 4 ... 10 mm | - |

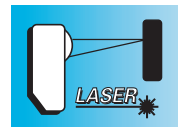

beam alignment (line)

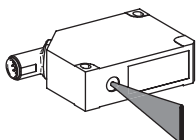

dimension drawing

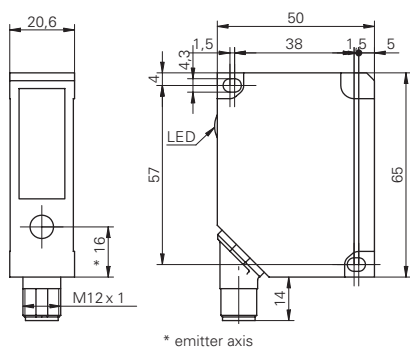

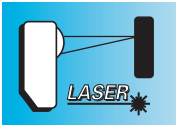

Sd = 100 ... 1000 mm

- current or voltage output
- resolution up to 0,5 mm
- with laser line for rough surfaces



OADM 20 Sd = 100 ... 1000 mm

general data

| | |
|-----------------------|----------------------------|
| sensing element | photoelectric array |
| adjustment | no |
| power on indication | LED green |
| soiled lens indicator | LED red / LED red blinking |
| light source | pulsed red laser diode |
| wave length | 675 nm |
| laser class | 2 |

measuring distance Sd = 100 ... 500 mm

| | |
|-----------------|----------|
| resolution | < 0,5 mm |
| linearity error | ± 1,5 mm |

measuring distance Sd = 200 ... 1000 mm

| | |
|-----------------|---------|
| resolution | < 3 mm |
| linearity error | ± 12 mm |

electrical data

| | |
|------------------------------|----------------------------|
| response time / release time | < 10 ms |
| voltage supply range +Vs | 12 ... 28 VDC |
| current consumption max. | 120 mA |
| output circuit | analog |
| output signal | 4 ... 20 mA / 0 ... 10 VDC |
| load resistance (analog I) | < (+Vs - 6 V) / 0,02 A |
| load resistance (analog U) | > 100 kOhm |
| output current | < 100 mA |
| alarm output | PNP |
| short circuit protection | yes |
| reverse polarity protection | yes, Vs to GND |

mechanical data

| | |
|------------------|---------------------------------|
| width / diameter | 20,6 mm |
| height / length | 65 mm |
| depth | 50 mm |
| housing material | die-cast zinc |
| front (optics) | glass |
| connection types | connector M12, 5 pin, rotatable |

ambient conditions

| | |
|-----------------------|--------------|
| operating temperature | 0 ... +50 °C |
| protection class | IP 67 |

connection diagram

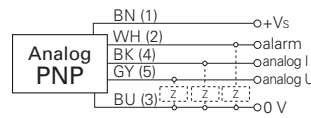

connectors

ES 34CP2B 5 pin 2 m straight (shielded)
 additional cable connectors and field wireable connectors, see accessories

accessories

mounting bracket 131521
 for details, see accessories section

remarks

While switching-on the sensor, it checks if there is a current at current output BK (4). If so, the current output is activated. If not, the voltage output GY (5) is activated after 100 ms.

laser warning

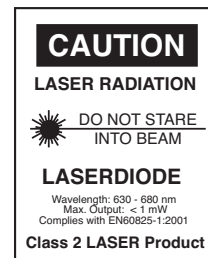

Distance sensors

| order reference | measuring distance Sd | beam type | beam width | beam height | beam diameter |
|-------------------|-----------------------|-----------|------------|---------------|---------------|
| OADM 20I4471/S14C | 100 ... 500 mm | point | - | - | 2 mm |
| OADM 20I4481/S14C | 200 ... 1000 mm | point | - | - | 2 mm |
| OADM 20I4571/S14C | 100 ... 500 mm | line | 2,5 mm | 5,5 ... 18 mm | - |
| OADM 20I4581/S14C | 200 ... 1000 mm | line | 2,5 mm | 8,5 ... 35 mm | - |

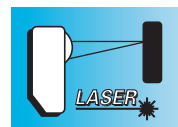

beam alignment (line)

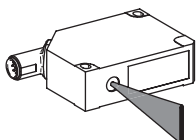

dimension drawing

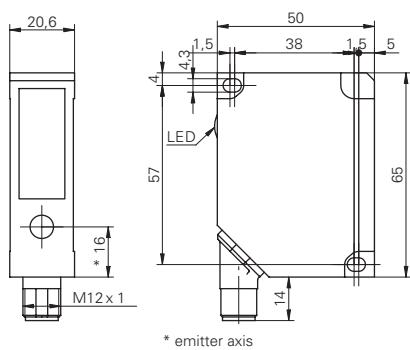

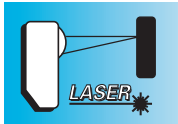

Sd = 30 ... 250 mm

- serial interface RS 485
- resolution up to 10 µm
- with laser line for rough surfaces



general data

| | |
|-----------------------|----------------------------|
| sensing element | photoelectric array |
| adjustment | no |
| power on indication | LED green |
| soiled lens indicator | LED red / LED red blinking |
| light source | pulsed red laser diode |
| wave length | 675 nm |
| laser class | 2 |

measuring distance Sd = 30 ... 50 mm

| | |
|-----------------|-----------|
| resolution | < 0,01 mm |
| linearity error | ± 0,03 mm |

measuring distance Sd = 30 ... 130 mm

| | |
|-----------------|-----------|
| resolution | < 0,06 mm |
| linearity error | ± 0,2 mm |

measuring distance Sd = 50 ... 250 mm

| | |
|-----------------|----------|
| resolution | < 0,3 mm |
| linearity error | ± 0,9 mm |

electrical data

| | |
|------------------------------|----------------|
| response time / release time | < 10 ms |
| voltage supply range +Vs | 12 ... 28 VDC |
| current consumption max. | 120 mA |
| output circuit | RS 485 |
| output current | < 100 mA |
| alarm output | push-pull |
| short circuit protection | yes |
| reverse polarity protection | yes, Vs to GND |

mechanical data

| | |
|------------------|---------------------------------|
| width / diameter | 20,6 mm |
| height / length | 65 mm |
| depth | 50 mm |
| housing material | die-cast zinc |
| front (optics) | glass |
| connection types | connector M12, 8 pin, rotatable |

ambient conditions

| | |
|-----------------------|--------------|
| operating temperature | 0 ... +50 °C |
| protection class | IP 67 |

connection diagram

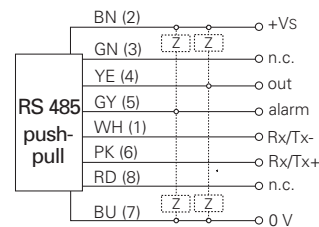

connectors

ESG 34FP0200B 8 pin 2 m straight (shielded)

additional cable connectors and field wireable connectors, see accessories

accessories

mounting bracket 131521

for details, see accessories section

remarks

The sensor has a switching output (out) that is activated when the measurement is determined within the range between threshold 1 and threshold 2. Both thresholds can be set via interface.

laser warning



| order reference | measuring distance Sd | beam type | beam width | beam height | beam diameter |
|-------------------|-----------------------|-----------|--------------|-------------|---------------|
| OADM 20S4440/S14F | 30 ... 50 mm | point | - | - | 1 ... 0,4 mm |
| OADM 20S4460/S14F | 30 ... 130 mm | point | - | - | 2 ... 1 mm |
| OADM 20S4470/S14F | 50 ... 250 mm | point | - | - | 2 mm |
| OADM 20S4540/S14F | 30 ... 50 mm | line | 1 ... 0,4 mm | 2 mm | - |
| OADM 20S4560/S14F | 30 ... 130 mm | line | 2 ... 1 mm | 3 ... 5 mm | - |
| OADM 20S4570/S14F | 50 ... 250 mm | line | 2,5 mm | 4 ... 10 mm | - |

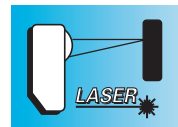

beam alignment (line)

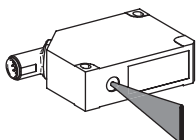

dimension drawing

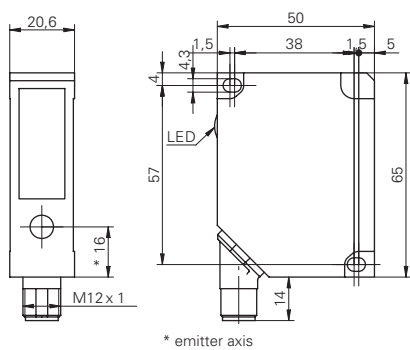

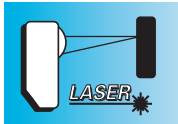

Sd = 100 ... 1000 mm

- measuring ranges from 30 to 1000 mm
- resolution up to 0,5 mm
- with laser line for rough surfaces



general data

| | |
|-----------------------|----------------------------|
| sensing element | photoelectric array |
| adjustment | no |
| power on indication | LED green |
| soiled lens indicator | LED red / LED red blinking |
| light source | pulsed red laser diode |
| wave length | 675 nm |
| laser class | 2 |

measuring distance Sd = 100 ... 500 mm

| | |
|-----------------|----------|
| resolution | < 0,5 mm |
| linearity error | ± 1,5 mm |

measuring distance Sd = 200 ... 1000 mm

| | |
|-----------------|---------|
| resolution | < 3 mm |
| linearity error | ± 12 mm |

electrical data

| | |
|------------------------------|----------------|
| response time / release time | < 10 ms |
| voltage supply range +Vs | 12 ... 28 VDC |
| current consumption max. | 120 mA |
| output circuit | RS 485 |
| output current | < 100 mA |
| alarm output | push-pull |
| short circuit protection | yes |
| reverse polarity protection | yes, Vs to GND |

mechanical data

| | |
|------------------|---------------------------------|
| width / diameter | 20,6 mm |
| height / length | 65 mm |
| depth | 50 mm |
| housing material | die-cast zinc |
| front (optics) | glass |
| connection types | connector M12, 8 pin, rotatable |

ambient conditions

| | |
|-----------------------|--------------|
| operating temperature | 0 ... +50 °C |
| protection class | IP 67 |

connection diagram

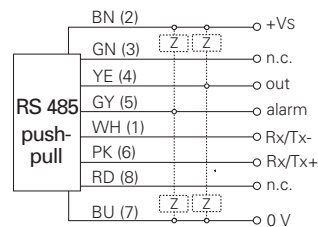

connectors

ESG 34FP0200B 8 pin 2 m straight (shielded)
 additional cable connectors and field wireable connectors, see accessories

accessories

mounting bracket 131521
 for details, see accessories section

remarks

The sensor has a switching output (out) that is activated when the measurement is determined within the range between threshold 1 and threshold 2. Both thresholds can be set via interface.

laser warning



| order reference | measuring distance Sd | beam type | beam width | beam height | beam diameter |
|-------------------|-----------------------|-----------|------------|---------------|---------------|
| OADM 20S4471/S14F | 100 ... 500 mm | point | - | - | 2 mm |
| OADM 20S4481/S14F | 200 ... 1000 mm | point | - | - | 2 mm |
| OADM 20S4571/S14F | 100 ... 500 mm | line | 2,5 mm | 5,5 ... 18 mm | - |
| OADM 20S4581/S14F | 200 ... 1000 mm | line | 2,5 mm | 8,5 ... 35 mm | - |

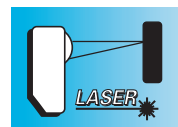

beam alignment (line)

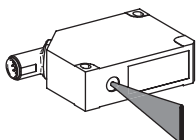

dimension drawing

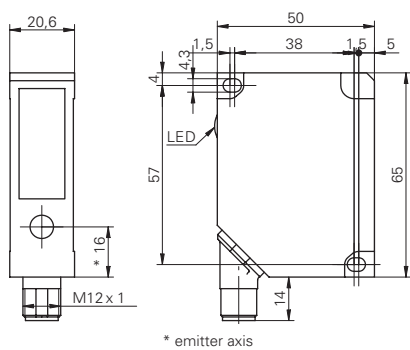

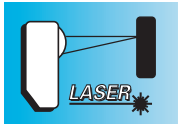

Sd = 30 ... 300 mm

- synchronization input
- teachable measuring range
- resolution up to 4 µm



general data

| | |
|-----------------------|-----------------------------|
| sensing element | photoelectric array |
| adjustment | Teach-in: button / external |
| power on indication | LED green |
| soiled lens indicator | LED red / LED red blinking |
| light source | pulsed red laser diode |
| wave length | 675 nm |
| laser class | 2 |

measuring distance Sd = 30 ... 70 mm

| | |
|---------------------|-----------------------|
| Teach-in range min. | > 2 mm |
| resolution | 0,004 ... 0,02 mm |
| linearity error | ± 0,012 ... ± 0,06 mm |

measuring distance Sd = 30 ... 130 mm

| | |
|---------------------|----------------------|
| Teach-in range min. | > 3 mm |
| resolution | 0,005 ... 0,06 mm |
| linearity error | ± 0,015 ... ± 0,2 mm |

measuring distance Sd = 50 ... 300 mm

| | |
|---------------------|-------------------|
| Teach-in range min. | > 5 mm |
| resolution | 0,01 ... 0,33 mm |
| linearity error | ± 0,03 ... ± 1 mm |

electrical data

| | |
|------------------------------|----------------------------|
| response time / release time | < 0,9 ms |
| voltage supply range +Vs | 12 ... 28 VDC |
| current consumption max. | 120 mA |
| output circuit | analog |
| output signal | 4 ... 20 mA / 0 ... 10 VDC |
| load resistance (analog I) | < (+Vs - 6 V) / 0,02 A |
| load resistance (analog U) | > 100 kOhm |
| output current | < 100 mA |
| alarm output | PNP |
| short circuit protection | yes |
| reverse polarity protection | yes, Vs to GND |

mechanical data

| | |
|------------------|---------------------------------|
| width / diameter | 20,6 mm |
| height / length | 65 mm |
| depth | 50 mm |
| housing material | die-cast zinc |
| front (optics) | glass |
| connection types | connector M12, 8 pin, rotatable |

ambient conditions

| | |
|-----------------------|--------------|
| operating temperature | 0 ... +50 °C |
| protection class | IP 67 |

connection diagram

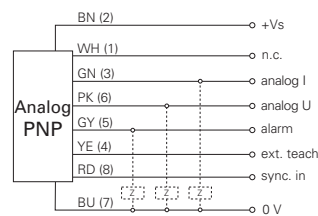

connectors

ESG 34FP0200B 8 pin 2 m straight (shielded)
 additional cable connectors and field wireable connectors, see accessories

accessories

mounting bracket 131521
 for details, see accessories section

laser warning

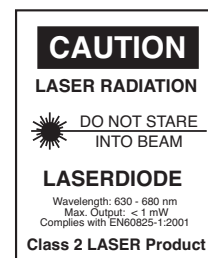

| order reference | measuring distance Sd | beam type | beam width | beam height | beam diameter |
|-------------------|-----------------------|-----------|--------------|-------------|---------------|
| OADM 20I6441/S14F | 30 ... 70 mm | point | - | - | 1 ... 0,2 mm |
| OADM 20I6460/S14F | 30 ... 130 mm | point | - | - | 2 ... 1 mm |
| OADM 20I6472/S14F | 50 ... 300 mm | point | - | - | 2 mm |
| OADM 20I6541/S14F | 30 ... 70 mm | line | 1 ... 0,2 mm | 2 mm | - |
| OADM 20I6560/S14F | 30 ... 130 mm | line | 2 ... 1 mm | 3 ... 5 mm | - |
| OADM 20I6572/S14F | 50 ... 300 mm | line | 2,5 mm | 4 ... 12 mm | - |

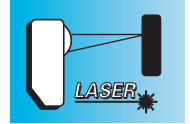

resolution

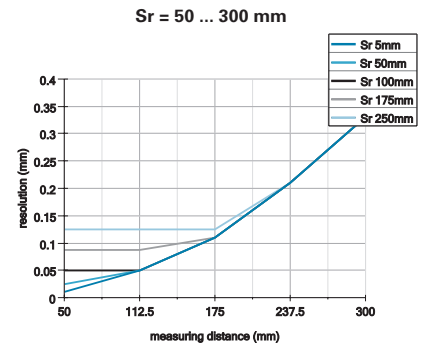
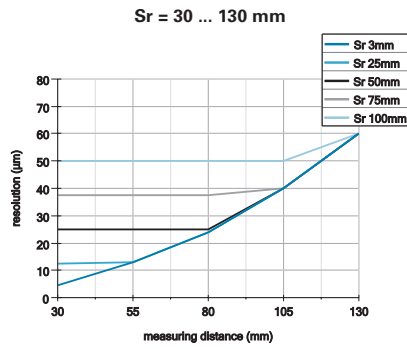
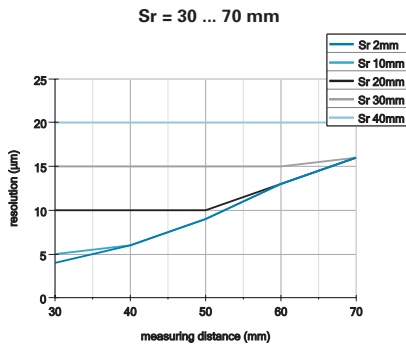

linearity error

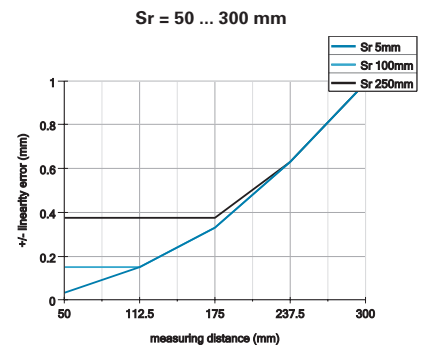
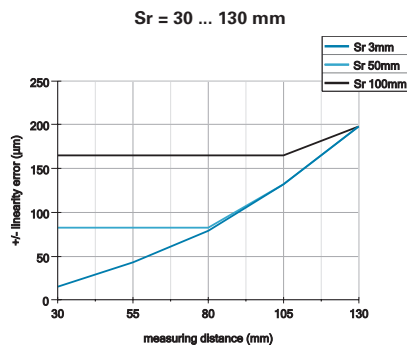
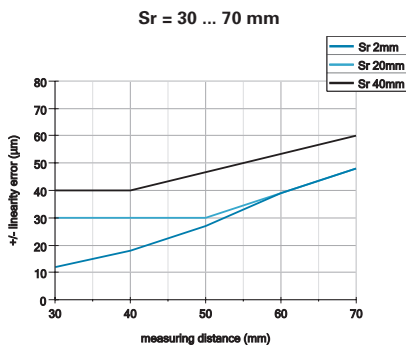

beam alignment (line)

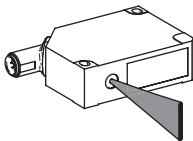

dimension drawing

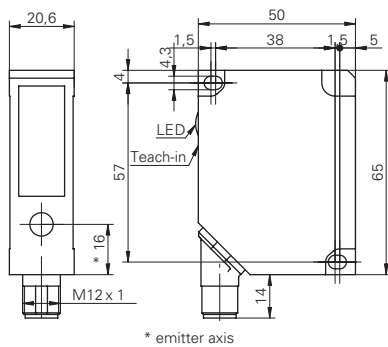

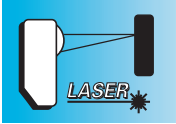

Sd = 100 ... 1000 mm

- synchronization input
- teachable measuring range
- resolution up to 15 µm



OADM 20 Sd = 100 ... 1000 mm

general data

| | |
|-----------------------|-----------------------------|
| sensing element | photoelectric array |
| adjustment | Teach-in: button / external |
| power on indication | LED green |
| soiled lens indicator | LED red / LED red blinking |
| light source | pulsed red laser diode |
| wave length | 675 nm |
| laser class | 2 |

measuring distance Sd = 100 ... 600 mm

| | |
|---------------------|-------------------|
| Teach-in range min. | > 10 mm |
| resolution | 0,015 ... 0,67 mm |
| linearity error | ± 0,05 ... ± 2 mm |

measuring distance Sd = 200 ... 1000 mm

| | |
|---------------------|--------------------|
| Teach-in range min. | > 20 mm |
| resolution | 0,12 ... 3 mm |
| linearity error | ± 0,48 ... ± 12 mm |

electrical data

| | |
|-----------------------------|----------------------------|
| voltage supply range +Vs | 12 ... 28 VDC |
| current consumption max. | 120 mA |
| output circuit | analog |
| output signal | 4 ... 20 mA / 0 ... 10 VDC |
| load resistance (analog I) | < (+Vs - 6 V) / 0,02 A |
| load resistance (analog U) | > 100 kOhm |
| output current | < 100 mA |
| alarm output | PNP |
| short circuit protection | yes |
| reverse polarity protection | yes, Vs to GND |

measuring distance Sd = 100 ... 600 mm

| | |
|------------------------------|----------|
| response time / release time | < 0,9 ms |
|------------------------------|----------|

measuring distance Sd = 200 ... 1000 mm

| | |
|------------------------------|----------|
| response time / release time | < 2,8 ms |
|------------------------------|----------|

mechanical data

| | |
|------------------|---------------------------------|
| width / diameter | 20,6 mm |
| height / length | 65 mm |
| depth | 50 mm |
| housing material | die-cast zinc |
| front (optics) | glass |
| connection types | connector M12, 8 pin, rotatable |

ambient conditions

| | |
|-----------------------|--------------|
| operating temperature | 0 ... +50 °C |
| protection class | IP 67 |

connection diagram

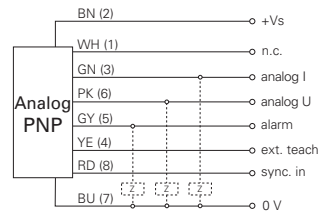

connectors

ESG 34FP0200B 8 pin 2 m straight (shielded)
 additional cable connectors and field wireable connectors, see accessories

accessories

mounting bracket 131521
 for details, see accessories section

laser warning



Distance sensors

| order reference | measuring distance Sd | beam type | beam width | beam height | beam diameter |
|-------------------|-----------------------|-----------|------------|---------------|---------------|
| OADM 20I6480/S14F | 100 ... 600 mm | point | - | - | 2 mm |
| OADM 20I6481/S14F | 200 ... 1000 mm | point | - | - | 2 mm |
| OADM 20I6580/S14F | 100 ... 600 mm | line | 2,5 mm | 5,5 ... 21 mm | - |
| OADM 20I6581/S14F | 200 ... 1000 mm | line | 2,5 mm | 8,5 ... 35 mm | - |

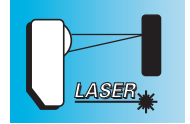

resolution

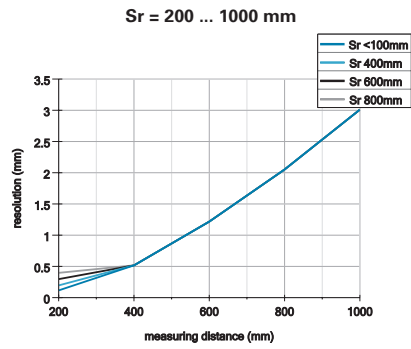
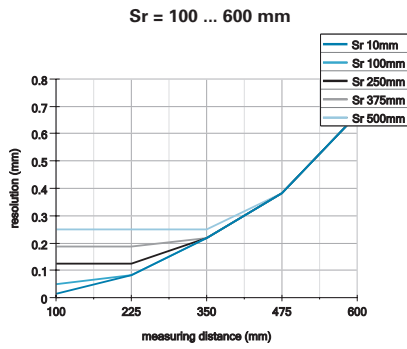

linearity error

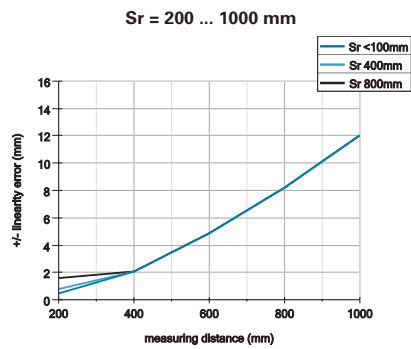
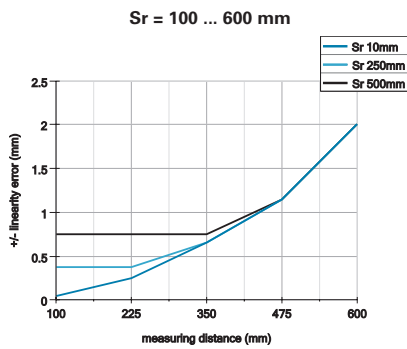

beam alignment (line)

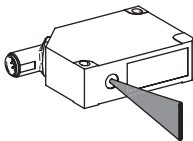

dimension drawing

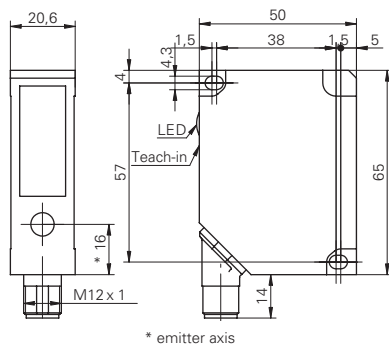

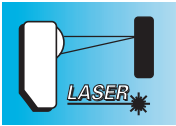

Sd = 200 ... 1000 mm

- teachable measuring range
- resolution up to 20 µm
- synchronization input

general data

| | |
|-----------------------|-----------------------------|
| sensing element | photoelectric array |
| measuring distance Sd | 200 ... 1000 mm |
| adjustment | Teach-in: button / external |
| Teach-in range min. | > 10 mm |
| power on indication | LED green |
| soiled lens indicator | LED red / LED red blinking |
| resolution | 0,02 ... 0,5 mm |
| linearity error | ± 0,08 ... ± 2 mm |
| light source | pulsed red laser diode |
| wave length | 675 nm |
| laser class | 2 |

electrical data

| | |
|------------------------------|----------------------------|
| response time / release time | < 10 ms |
| voltage supply range +Vs | 12 ... 28 VDC |
| current consumption max. | 120 mA |
| output circuit | analog |
| output signal | 4 ... 20 mA / 0 ... 10 VDC |
| load resistance (analog I) | < (+Vs - 6 V) / 0,02 A |
| load resistance (analog U) | > 100 kOhm |
| output current | < 100 mA |
| alarm output | PNP |
| short circuit protection | yes |
| reverse polarity protection | yes, Vs to GND |

mechanical data

| | |
|------------------|---------------------------------|
| width / diameter | 20,4 mm |
| height / length | 135 mm |
| depth | 45 mm |
| housing material | aluminum |
| front (optics) | glass |
| connection types | connector M12, 8 pin, rotatable |

ambient conditions

| | |
|-----------------------|--------------|
| operating temperature | 0 ... +50 °C |
| protection class | IP 67 |



connection diagram

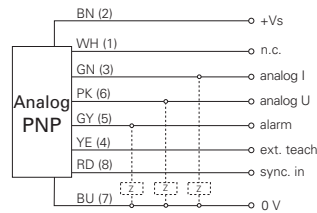

connectors

ESG 34FP0200B 8 pin 2 m straight (shielded)
 additional cable connectors and field wireable connectors, see accessories

laser warning



| order reference | beam type | beam width | beam height | beam diameter |
|-------------------|-----------|------------|-------------|---------------|
| OADM 21I6481/S14F | point | - | - | 2 mm |
| OADM 21I6581/S14F | line | 2,5 mm | 6 ... 20 mm | - |

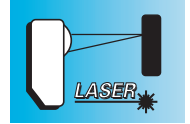

resolution

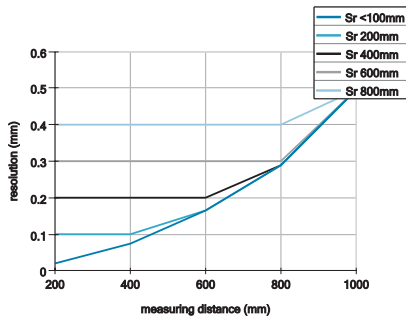

linearity error

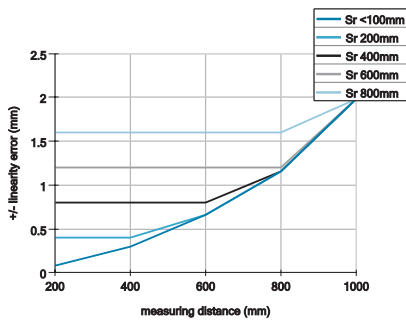



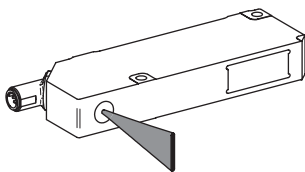

beam alignment (line)

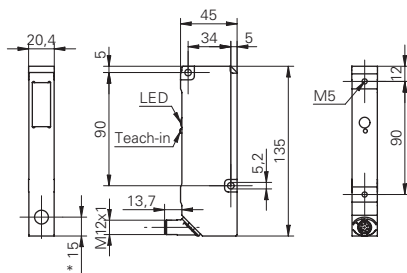

dimension drawing



* emitter axis

| product family | OBDM 12 | OBDM 12 | OBDM 12 | OBDM 12 | OBDM 12 |
|---------------------|---|---|---|---|---|
| |  |  |  |  |  |
| type | step analysis | min./max. analysis | tolerance analysis | window analysis | 2-point comparison |
| width / diameter | 12,4 mm | 12,4 mm | 12,4 mm | 12,4 mm | 12,4 mm |
| sensing distance Tw | 16 ... 120 mm | 16 ... 120 mm | 16 ... 120 mm | 16 ... 120 mm | 16 ... 120 mm |
| response time | < 5 ms | < 1 ms | < 1 ms | < 1 ms | < 1 ms |
| NPN | ■ | ■ | ■ | ■ | ■ |
| PNP | ■ | ■ | ■ | ■ | ■ |
| connection types | connector | connector | connector | connector | connector |
| housing material | metal | metal | metal | metal | metal |
| | | | | | |
| Page | 237 | 238 | 239 | 240 | 241 |



General information

The range of difference sensors opens new perspectives in the field of sensing. The patented functions provide the user with new, innovative solutions in the detection of objects, monitoring of tolerances or the comparison of object sizes and object positions. With the fine laser beam and the high insensitivity of the sensor to colors, objects are accurately detected. Five different sensors with different functions are available according to the application.

- Difference sensors with:
- Step analysis
 - Window analysis
 - Tolerance analysis
 - Min./max. analysis
 - 2-point comparisons

Characteristics and advantages

Difference evaluation

Distance-measuring sensors with integrated logic for distance difference evaluation. Complex evaluation by the connected controller is no longer necessary, saving time and costs.

Nominal difference teachable

With the standardized Teach-in process of Baumer electric, the nominal difference can be quickly and easily programmed.

Switching output

The comparison of the actual and nominal difference is made internally by the sensors and is issued at the switching output as a simply assessed pass/fail signal.

In some other applications, objects with rough and uneven surfaces must be measured. Sometimes, the surface of the object even has small holes or gaps. Such objects can be easily measured using a laser line optical system, which supplies a fine laser line in place of a focused laser beam.

Applications and functions

Difference sensors with step analysis

In step analysis, objects are detected by their height difference (stage) and reported in the form of a digital output signal.

The sensor evaluates the positive or negative height difference within a specified time window of max. 5 ms. If the height difference is greater than 50% of the taught-in value, an impulse of at least 10 ms is issued at the output. When the value is less than 50%, the sensor switches back to the OFF state. If height differences are smaller than 50% of the taught value within the time window (e.g. fluctuation of the conveyor belt), the sensor remains in the OFF state.

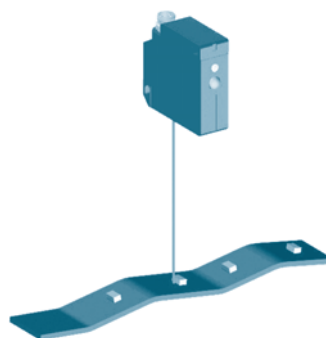

- The stage / edge from which the objects are detected can be adjusted (minimum object height 0,2 mm)
- Defined output impulse of 10 ms (can also be read by a normal PLC)
- Detection of objects on a fluctuation conveyor belt
- Detection of stages or edges
- Positioning of objects by an edge, regardless of the distance



Applications and functions

Difference sensors with min./max. analysis

With min./max. analysis, objects can be inspected and monitored according to their scanned contour or shape. The scanning of the objects is activated by an external control signal. At the end of a detection sequence, the measured values are evaluated and the difference between the minimum and maximum values is determined. If the difference exceeds a nominal difference previously taught into the sensor, this is reported in the form of an ON signal. This signal remains active until a new detection sequence is started. When this starts, the output returns to the OFF state. If the difference is smaller than the nominal difference, the output remains in the OFF state.



- Difference is detected regardless of the distance
- Start and stop of the measuring cycle can be determined independently
- Easily evaluated pass/fail signal
- Round true running or knock of wheels / discs can be checked regardless of the distance
- Deformation of plastic parts after cooling can be checked

Difference sensors with tolerance analysis

The dimensional tolerance of objects can be determined by tolerance analysis. In the continuous detection of object distances, all measured values are checked to determine if it is between the specified maximum and minimum tolerances. In the case of if being between, an ON signal is issued at the output. If the distance remains within the tolerance range, the sensor remains in the OFF state.

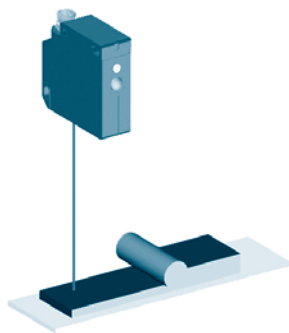

- Sensor form of a caliper gauge
- Simple monitoring of a distance with a tolerance range (pass/fail information)
- Tolerance range and nominal distance can be taught in separately
- Material thickness checking after a roller mill
- Material thickness checking for extruders



Applications and functions

Difference sensors with window analysis

With window analysis, objects can be classified by a specified switching window.

For this purpose, the switching window is specified in a simple Teach-in procedure with upper and lower limits. If an object is outside the defined limits, this is reported at the switching output.

- Foreground and background suppression in a single sensor

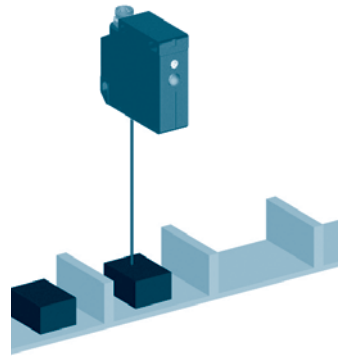

- Positions can be taught in separately
- Smallest window 0,45 mm
- Interfering objects in the foreground and background can be suppressed
- Objects can be detected on a segmented conveyor belt

Difference sensors with 2-point comparison

In a 2-point comparison, two distances detected at two specifically chosen times are measured and compared.

The choice of the time is made using a sync signal. The first distance is measured at the rising flank of the signal and the second distance at the falling flank of the signal. After the second distance has been measured, the sensor evaluates the difference between the two distances and compares this with a previously taught-in maximum permissible deviation. If this is exceeded, the output assumes the ON state.

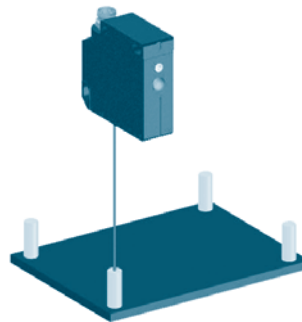

- Object heights can be compared regardless of the distance
- Deviation can be taught in (min. 0,3 mm)
- Measuring time can be determined separately by an external signal
- Checking the pressing depth of pins
- Comparison of the distances/heights of objects with a reference value



Mounting and adjustment

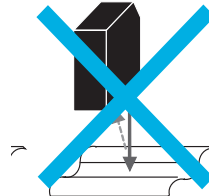
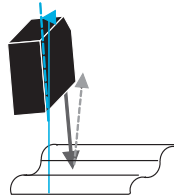

The direct reflection from glossy or reflective objects must not impinge on the receiver. This can be avoided by slightly tilting the sensor.

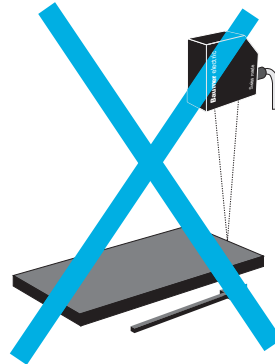
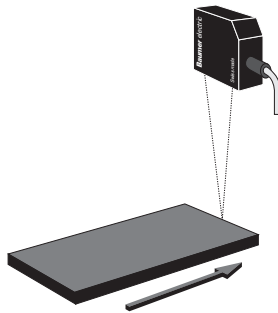

For optimum measurement results, the sensor must be installed perpendicular to the movement of the object.

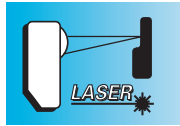

Tw = 16 ... 120 mm

- detection of edges/steps independent of the distance
- reference steps adjustable
- min. output pulse 10 ms



general data

| | |
|---------------------|------------------------|
| type | step analysis |
| sensing distance Tw | 16 ... 120 mm |
| Teach-in range min. | > 0,2 mm |
| adjustment | Teach-in |
| power on indication | LED green |
| output indicator | LED red |
| light source | pulsed red laser diode |
| laser class | 2 |
| wave length | 675 nm |
| beam diameter | 0,5 ... 0,2 |

electrical data

| | |
|-----------------------------|----------------|
| response time | < 5 ms |
| voltage supply range +Vs | 12 ... 28 VDC |
| current consumption max. | 80 mA |
| current consumption typ. | 40 mA |
| output current | < 100 mA |
| output pulse length | 10 ms |
| voltage drop Vd | < 2,8 VDC |
| reverse polarity protection | yes, Vs to GND |
| short circuit protection | yes |

mechanical data

| | |
|------------------|---------------------|
| width / diameter | 12,4 mm |
| height / length | 37 mm |
| depth | 34,5 mm |
| type | rectangular |
| front (optics) | glass |
| housing material | die-cast zinc |
| connection types | connector M8, 4 pin |

ambient conditions

| | |
|-----------------------|--------------|
| operating temperature | 0 ... +50 °C |
| protection class | IP 67 |

connectors

| | | |
|--------------|-------|--------------|
| ESG 32AH0200 | 4 pin | 2 m straight |
| ESW 31AH0200 | 4 pin | 2 m angular |

additional cable connectors and field wireable connectors, see accessories

accessories

| | |
|-----------------------|--------|
| SENSOFIX mounting kit | 150328 |
| mounting bracket | 113873 |

for details, see accessories section

order reference **output circuit**

| | |
|-------------------|-----|
| OBDM 12N6910/S35A | NPN |
| OBDM 12P6910/S35A | PNP |

dimension drawing

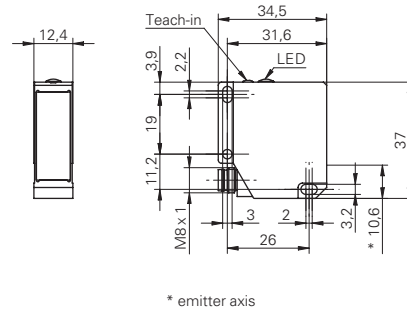

* emitter axis

connection diagrams

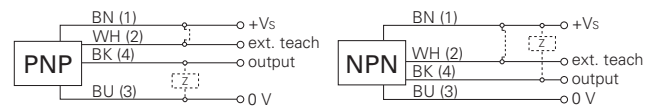

min. detectable difference

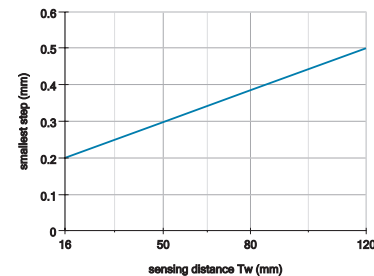

laser warning

CAUTION

LASER RADIATION

DO NOT STARE INTO BEAM

LASERDIODE

Wavelength: 630 - 680 nm
Max. Output: < 1 mW
Complies with EN60825-1:2001

Class 2 LASER Product

OBDM 12 Tw = 16 ... 120 mm

Difference sensors

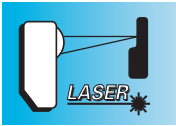

Tw = 16 ... 120 mm

- analysis of distance differences (min./max.)
- max. difference tolerance adjustable
- measuring time selectable



general data

| | |
|---------------------|------------------------|
| type | min./max. analysis |
| sensing distance Tw | 16 ... 120 mm |
| Teach-in range min. | > 0,3 mm |
| adjustment | Teach-in |
| power on indication | LED green |
| output indicator | LED red |
| light source | pulsed red laser diode |
| laser class | 2 |
| wave length | 675 nm |
| beam diameter | 0,5 ... 0,2 |

electrical data

| | |
|-----------------------------|----------------|
| response time | < 1 ms |
| voltage supply range +Vs | 12 ... 28 VDC |
| current consumption max. | 80 mA |
| current consumption typ. | 40 mA |
| output current | < 100 mA |
| voltage drop Vd | < 2,8 VDC |
| reverse polarity protection | yes, Vs to GND |
| short circuit protection | yes |

mechanical data

| | |
|------------------|---------------------|
| width / diameter | 12,4 mm |
| height / length | 37 mm |
| depth | 34,5 mm |
| type | rectangular |
| front (optics) | glass |
| housing material | die-cast zinc |
| connection types | connector M8, 4 pin |

ambient conditions

| | |
|-----------------------|--------------|
| operating temperature | 0 ... +50 °C |
| protection class | IP 67 |

connectors

| | | |
|--------------|-------|--------------|
| ESG 32AH0200 | 4 pin | 2 m straight |
| ESW 31AH0200 | 4 pin | 2 m angular |

additional cable connectors and field wireable connectors, see accessories

accessories

| | |
|-----------------------|--------|
| SENSOFIX mounting kit | 150328 |
| mounting bracket | 113873 |

for details, see accessories section

order reference

| order reference | output circuit |
|-------------------|----------------|
| OBDM 12N6920/S35A | NPN |
| OBDM 12P6920/S35A | PNP |

dimension drawing

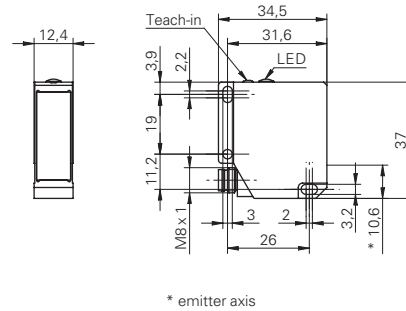

connection diagrams

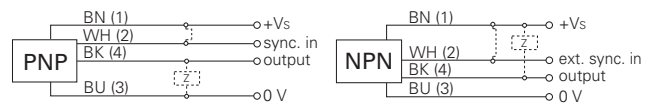

min. detectable difference

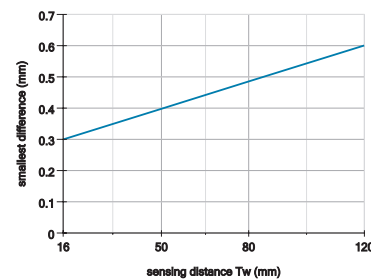

laser warning



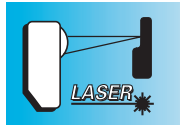

Tw = 16 ... 120 mm



- distance monitoring within a tolerance band
- nominal distance
- adjustable tolerance band

general data

| | |
|---------------------|------------------------|
| type | tolerance analysis |
| sensing distance Tw | 16 ... 120 mm |
| Teach-in range min. | > 0,4 mm |
| adjustment | Teach-in |
| power on indication | LED green |
| output indicator | LED red |
| light source | pulsed red laser diode |
| laser class | 2 |
| wave length | 675 nm |
| beam diameter | 0,5 ... 0,2 |

electrical data

| | |
|-----------------------------|----------------|
| response time | < 1 ms |
| voltage supply range +Vs | 12 ... 28 VDC |
| current consumption max. | 80 mA |
| current consumption typ. | 40 mA |
| output current | < 100 mA |
| voltage drop Vd | < 2,8 VDC |
| reverse polarity protection | yes, Vs to GND |
| short circuit protection | yes |

mechanical data

| | |
|------------------|---------------------|
| width / diameter | 12,4 mm |
| height / length | 37 mm |
| depth | 34,5 mm |
| type | rectangular |
| front (optics) | glass |
| housing material | die-cast zinc |
| connection types | connector M8, 4 pin |

ambient conditions

| | |
|-----------------------|--------------|
| operating temperature | 0 ... +50 °C |
| protection class | IP 67 |

connectors

| | | |
|--------------|-------|--------------|
| ESG 32AH0200 | 4 pin | 2 m straight |
| ESW 31AH0200 | 4 pin | 2 m angular |

additional cable connectors and field wireable connectors, see accessories

accessories

| | |
|-----------------------|--------|
| SENSOFIX mounting kit | 150328 |
| mounting bracket | 113873 |

for details, see accessories section

order reference output circuit

| | |
|-------------------|-----|
| OBDM 12N6930/S35A | NPN |
| OBDM 12P6930/S35A | PNP |

dimension drawing

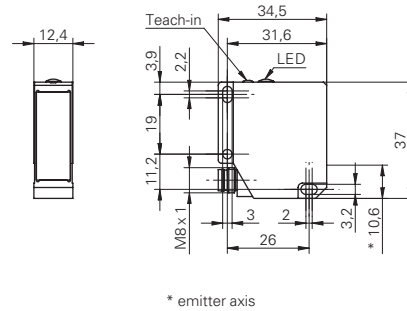

* emitter axis

connection diagrams

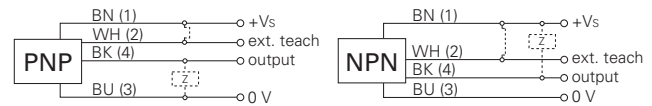

min. detectable difference

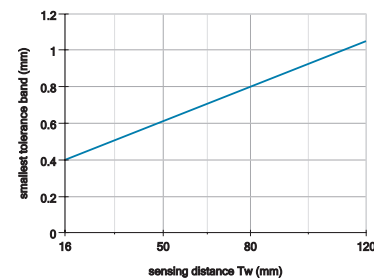

laser warning



OBDM 12 Tw = 16 ... 120 mm

Difference sensors

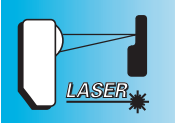

Tw = 16 ... 120 mm

- range switch (foreground / background suppression)
- adjustable window



OBDM 12 Tw = 16 ... 120 mm

general data

| | |
|---------------------|------------------------|
| type | window analysis |
| sensing distance Tw | 16 ... 120 mm |
| Teach-in range min. | > 0,4 mm |
| adjustment | Teach-in |
| power on indication | LED green |
| output indicator | LED red |
| light source | pulsed red laser diode |
| laser class | 2 |
| wave length | 675 nm |
| beam diameter | 0,5 ... 0,2 |

electrical data

| | |
|-----------------------------|----------------|
| response time | < 1 ms |
| voltage supply range +Vs | 12 ... 28 VDC |
| current consumption max. | 80 mA |
| current consumption typ. | 40 mA |
| output current | < 100 mA |
| voltage drop Vd | < 2,8 VDC |
| reverse polarity protection | yes, Vs to GND |
| short circuit protection | yes |

mechanical data

| | |
|------------------|---------------------|
| width / diameter | 12,4 mm |
| height / length | 37 mm |
| depth | 34,5 mm |
| type | rectangular |
| front (optics) | glass |
| housing material | die-cast zinc |
| connection types | connector M8, 4 pin |

ambient conditions

| | |
|-----------------------|--------------|
| operating temperature | 0 ... +50 °C |
| protection class | IP 67 |

connectors

| | | |
|--------------|-------|--------------|
| ESG 32AH0200 | 4 pin | 2 m straight |
| ESW 31AH0200 | 4 pin | 2 m angular |

additional cable connectors and field wireable connectors, see accessories

accessories

| | |
|-----------------------|--------|
| SENSOFIX mounting kit | 150328 |
| mounting bracket | 113873 |

for details, see accessories section

order reference

| order reference | output circuit |
|-------------------|----------------|
| OBDM 12N6940/S35A | NPN |
| OBDM 12P6940/S35A | PNP |

dimension drawing

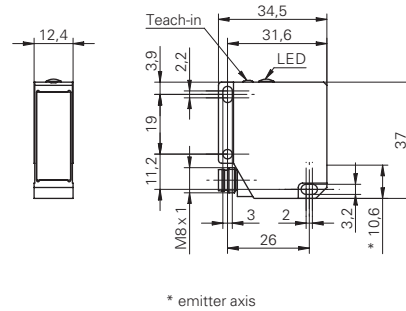

connection diagrams

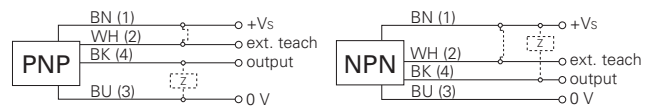

min. detectable difference

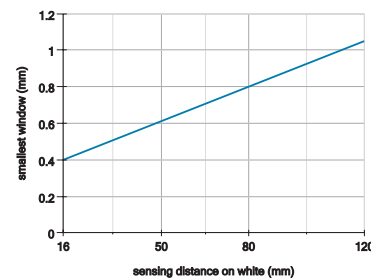

laser warning



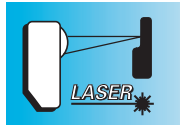

Tw = 16 ... 120 mm



- comparison of two distances
- max. tolerance adjustable
- specific measuring moment selectable

general data

| | |
|---------------------|------------------------|
| type | 2-point comparison |
| sensing distance Tw | 16 ... 120 mm |
| Teach-in range min. | > 0,3 mm |
| adjustment | Teach-in |
| power on indication | LED green |
| output indicator | LED red |
| light source | pulsed red laser diode |
| laser class | 2 |
| wave length | 675 nm |
| beam diameter | 0,5 ... 0,2 |

electrical data

| | |
|-----------------------------|----------------|
| response time | < 1 ms |
| voltage supply range +Vs | 12 ... 28 VDC |
| current consumption max. | 80 mA |
| current consumption typ. | 40 mA |
| output current | < 100 mA |
| voltage drop Vd | < 2,8 VDC |
| reverse polarity protection | yes, Vs to GND |
| short circuit protection | yes |

mechanical data

| | |
|------------------|---------------------|
| width / diameter | 12,4 mm |
| height / length | 37 mm |
| depth | 34,5 mm |
| type | rectangular |
| front (optics) | glass |
| housing material | die-cast zinc |
| connection types | connector M8, 4 pin |

ambient conditions

| | |
|-----------------------|--------------|
| operating temperature | 0 ... +50 °C |
| protection class | IP 67 |

connectors

| | | |
|--------------|-------|--------------|
| ESG 32AH0200 | 4 pin | 2 m straight |
| ESW 31AH0200 | 4 pin | 2 m angular |

additional cable connectors and field wireable connectors, see accessories

accessories

| | |
|-----------------------|--------|
| SENSOFIX mounting kit | 150328 |
| mounting bracket | 113873 |

for details, see accessories section

order reference output circuit

| | |
|-------------------|-----|
| OBDM 12N6950/S35A | NPN |
| OBDM 12P6950/S35A | PNP |

dimension drawing

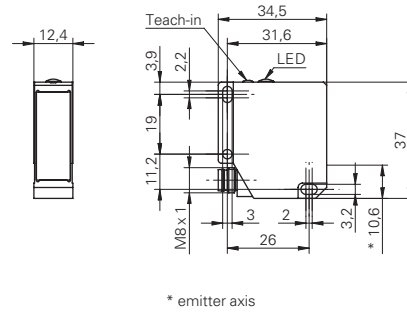

connection diagrams

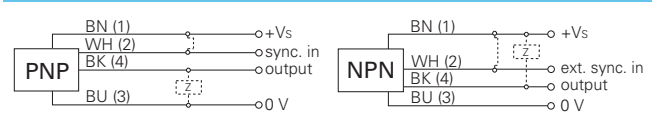

min. detectable difference

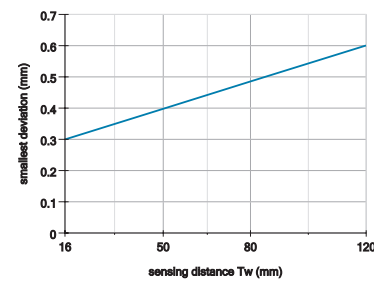







laser warning











OBDM 12 Tw = 16 ... 120 mm
Difference sensors

red light LED version

| product family | FHDK 04 | FHCK 07 | FHDK 07 | FHDK 10 | FHDK 10 | FHDK 10 | FHDK 10 |
|------------------------------|---|---|---|---|---|---|---|
| |  |  |  |  |  |  |  |
| | | MINOS | MINOS | | | | |
| | IO-Link | | | | | | |
| for glass detection | | | | | | | ■ |
| version | | | | | | line beam | |
| width / diameter | 4 mm | 8 mm | 8 mm | 10,4 mm | 10,4 mm | 10,4 mm | 10,4 mm |
| sensing distance Tw | 30 mm ±2 mm 50 mm ±3 mm | 10 ... 60 mm | 10 ... 60 mm | 30 mm ±3 mm 50 mm ±2 mm 80 mm ±8 mm | 20 ... 120 mm | 20 ... 80 mm | 10 ... 30 mm |
| response time / release time | < 0,5 ms | < 0,5 ms | < 0,5 ms | < 1 ms | < 1 ms | < 1 ms | < 1 ms |
| sensing distance adjustment | | Teach-in | Teach-in | | mechanical, 5 turn | mechanical, 5 turn | mechanical, 5 turn |
| push-pull | ■ | | | ■ | | | |
| NPN | | ■ | ■ | | ■ | ■ | ■ |
| PNP | | ■ | ■ | | ■ | ■ | ■ |
| cable | ■ | ■ | ■ | ■ | ■ | ■ | |
| connector | ■ | ■ | ■ | ■ | ■ | ■ | ■ |
| housing material | plastic | plastic | plastic | plastic | plastic | plastic | plastic |
| | | | | | | | |
| Page | 246 | 248 | 250 | 252 | 254 | 256 | 258 |

laser version

| product family | OHDK 10 | OHDM 12 | OHDK 14 | OHDM 16 | OHDM 16 | OHDM 20 |
|------------------------------|---|---|---|---|---|---|
| |  |  |  |  |  |  |
| | | IO-Link | | | | IO-Link |
| Wafer mapping sensor | | | | | ■ | |
| width / diameter | 10,4 mm | 12,4 mm | 14,8 mm | 15,4 mm | 15,4 mm | 20,6 mm |
| sensing distance Tw | 22 ... 130 mm | 17 ... 120 mm | 20 ... 350 mm | 25 ... 300 mm | 123 ... 143 mm | 210 ... 1500 mm |
| response time / release time | < 0,25 ms | | < 0,5 ms | < 0,1 ms < 0,6 ms | < 5 ms | |
| response time | | < 1 ms | | | | < 6 ms |
| release time | | < 2,7 ms | | | | < 18 ms |
| sensing distance adjustment | mechanical, 5 turn | Teach-in | mechanical, 9 turn | mechanical, 8 turn | no | Teach-in |
| NPN | ■ | ■ | ■ | ■ | ■ | |
| PNP | ■ | ■ | ■ | ■ | ■ | ■ |
| cable | ■ | | | ■ | ■ | |
| connector | ■ | ■ | ■ | ■ | | ■ |
| housing material | plastic | metal | plastic | metal | metal | metal |
| | | | | | | |
| Page | 260 | 264 | 270 | 274 | 276 | 280 |

| FHDM 12 | FHDK 14 | FHDK 14 | FHDM 16 | FHDK 20 | FHDK 26 |
|--|---|---|---|---|--|
|  |  |  |  |  |  |
| | | | | | |
|  IO-Link | | | | | |
| | | | | | |
| 12,4 mm | 14,8 mm | 14,8 mm | 15,4 mm | 20 mm | 25 mm |
| 15 ... 300 mm | 20 ... 350 mm 30 ... 500 mm | 40 ... 200 mm | 20 ... 450 mm 20 ... 600 mm | 30 ... 200 mm | 120 ... 400 mm |
| < 1 ms | < 1 ms < 5 ms | < 0,5 ms | < 1 ms < 5 ms | < 0,5 ms | < 1 ms |
| mechanical, 5 turn | mechanical, 10 turn | Teach-in | mechanical, 5 turn | Teach-in | mechanical, 9 turn |
| ■ | ■ | ■ | ■ | ■ | ■ |
| ■ | ■ | ■ | ■ | ■ | ■ |
| ■ | | | ■ | | ■ |
| ■ | ■ | ■ | ■ | ■ | ■ |
| metal | plastic | plastic | metal | plastic | plastic |
| | | | | | |
| 262 | 266 | 268 | 272 | 278 | 282 |

Diffuse sensors with background suppression



General information

Diffuse sensors with background suppression using the triangulation principle not only measure the light intensity reflected by the target, but also determine the distance of the object from the sensor. In this way, objects with the minimum size of the light beam located within the adjustable sensing distance can be detected regardless of their color and surface.

The diffuse sensors with background suppression and laser light source were developed specifically for applications in which exact positioning is important. With the finely focused beam, even very small objects such as the wires of a resistor or threads can be clearly detected or counted.

Applications

- Detection of boxes, metal and plastic parts lying on a base such as a conveyor belt, table or transport trolley from above
- Detection of bulk materials or other non-transparent materials in a container
- Counting of different-colored objects such as plastic bottles or printed packages
- Reliable presence monitoring of assembly parts, even with objects moving in the background

Characteristics and advantages

Adjustable sensing distance

The switching point can be adjusted accurately between the object and the interfering background using a set screw or teach-in method

Largely independent of color

The sensing distance remains constant even if the color of the objects changes. Readjustment is therefore unnecessary. Objects changing in the background also have no effect.

Small spot size

Laser sensors can detect objects with a size of just 0,1 mm. Sensors with pinpoint diodes have a spot of only 2 mm diameter at the focus.

Red light emitters

Visible red light permits simple adjustment of the sensor to small objects by eye.

Short response time

Small, quickly moving objects are reliably detected due to the short response time.

Technology and operation

The sensors are based on the triangulation principle. Only the angle of the light reflected back from the object determines the distance at which the sensor responds. The amount of reflected light is far less important.

The schematic sketch below shows that receiver R1 receives the light reflected back from the object T1 (acute angle of incidence) and receiver R2 the light reflected back from the background (shallow angle of incidence). The transition from R1 to R2 determines the sensing distance.

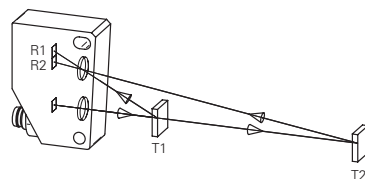

Diffuse sensors with background suppression



Mounting and adjustment

The diffuse sensor must be aimed at the object. The sensing distance must be set to a distance between the target and the background. The background must be located behind the adjusted sensing distance by at least the distance of the sensing distance reduction of the sensor to black.

For diffuse sensors with background suppression, the sensing range diagram is specified for the optimum adjustment. This indicates the sensing range reduction as a function of the sensing range to white for different degrees of remission. This means the distance by which the sensing distance to black or gray is reduced in comparison with white. When the adjusted sensing range to white is entered on the X axis of the diagram, the reduction of the sensing distance to black or gray can be read off on the Y axis. The sensing distance reduction also indicates the minimum distance a black or gray object must be separated from a white background.

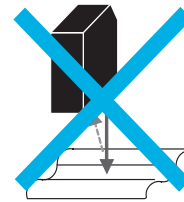
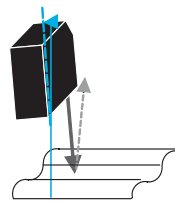
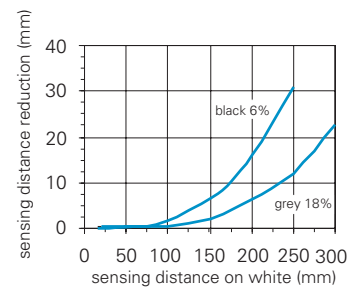

The direct reflection from glossy or reflective objects must not impinge on the receiver. This can be avoided by slightly tilting the sensor.

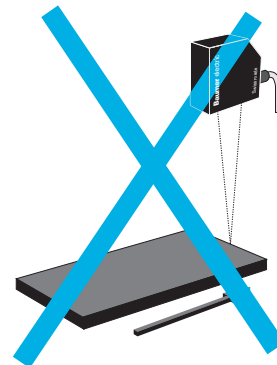
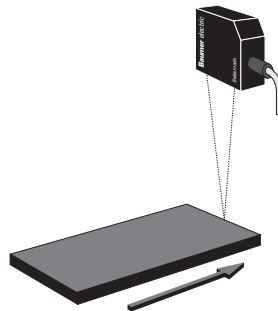

It should be ensured that the object to be detected approaches the active area of the sensor from the side, which avoids malfunctions caused by deflection of the light beam at edges.

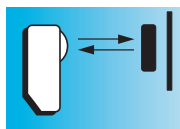

Tw = 50 mm



- subminiature housing
- fixed sensing distance
- push-pull output



general data

| | |
|-------------------------------------|--------------------------|
| type | background suppression |
| light source | pulsed point source LED |
| alignment / soiled lens indicator | flashing light indicator |
| light indicator | LED yellow |
| wave length | 660 nm |
| suppression of reciprocal influence | yes |

electrical data

| | |
|------------------------------|------------------|
| response time / release time | < 0,5 ms |
| voltage supply range +Vs | 11 ... 30 VDC |
| current consumption max. | 30 mA |
| current consumption typ. | 20 mA |
| voltage drop Vd | < 2 VDC |
| output circuit | push-pull |
| output current | < 50 mA |
| short circuit protection | yes |
| reverse polarity protection | yes, supply only |

mechanical data

| | |
|------------------|---------------|
| width / diameter | 4 mm |
| height / length | 44,8 mm |
| depth | 6,2 mm |
| type | rectangular |
| housing material | plastic (ASA) |
| front (optics) | PMMA |

ambient conditions

| | |
|-----------------------|----------------|
| operating temperature | -10 ... +50 °C |
| protection class | IP 65 |

connection diagrams

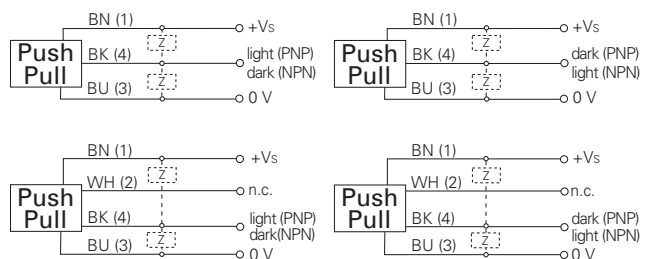

connectors

| | | |
|--------------|-------|--------------|
| ESG 32AH0200 | 4 pin | 2 m straight |
| ESW 31AH0200 | 4 pin | 2 m angular |

additional cable connectors and field wireable connectors, see accessories

accessories

| | |
|---------------|--------|
| mounting brad | 162920 |
|---------------|--------|

for details, see accessories section

| order reference | sensing distance Tw | connection types | output function |
|--------------------|---------------------|-----------------------------|-----------------|
| FHDK 04G6101 | 30 mm ±2 mm | cable 3 pin | light operate |
| FHDK 04G6101/KS35A | 30 mm ±2 mm | flylead connector M8, 4 pin | light operate |
| FHDK 04G6102 | 50 mm ±3 mm | cable 3 pin | light operate |
| FHDK 04G6102/KS35A | 50 mm ±3 mm | flylead connector M8, 4 pin | light operate |
| FHDK 04G6111 | 30 mm ±2 mm | cable 3 pin | dark operate |
| FHDK 04G6111/KS35A | 30 mm ±2 mm | flylead connector M8, 4 pin | dark operate |
| FHDK 04G6112 | 50 mm ±3 mm | cable 3 pin | dark operate |
| FHDK 04G6112/KS35A | 50 mm ±3 mm | flylead connector M8, 4 pin | dark operate |

FHDK 04 Tw = 50 mm Diffuse sensors with background suppression

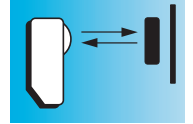

sensing distance diagram

Tw = 30 mm ± 2 mm



Tw = 50 mm ± 3 mm

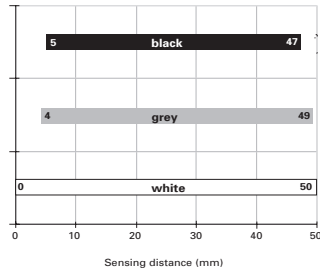

dimension drawings

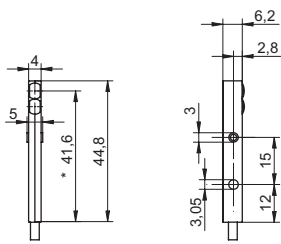

* emitter axis

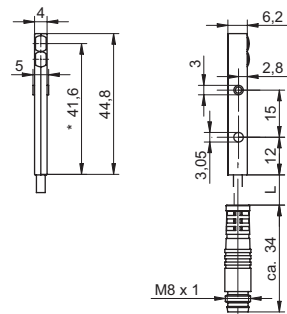

* emitter axis cable length L = 200 mm

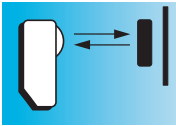

$T_w = 10 \dots 60 \text{ mm}$



- ultra compact housing
- sensing distance adjustable via Teach-in
- suppression of mutual optical interference

general data

| | |
|-------------------------------------|--------------------------|
| type | background suppression |
| light source | pulsed red LED |
| sensing distance T_w | 10 ... 60 mm |
| sensing range T_b (at T_w max.) | 2 ... 60 mm |
| sensing range T_b (at T_w min.) | 5 ... 10 mm |
| alignment / soiled lens indicator | flashing light indicator |
| light indicator | LED green |
| output indicator | LED yellow |
| sensing distance adjustment | Teach-in |
| wave length | 660 nm |
| suppression of reciprocal influence | yes |

electrical data

| | |
|------------------------------|----------------------|
| response time / release time | < 0,5 ms |
| voltage supply range +Vs | 10 ... 30 VDC |
| current consumption max. | 25 mA |
| current consumption typ. | 20 mA |
| voltage drop V_d | < 1,8 VDC |
| output function | light / dark operate |
| output current | < 100 mA |
| short circuit protection | yes |
| reverse polarity protection | yes |

mechanical data

| | |
|------------------|--------------------------|
| width / diameter | 8 mm |
| height / length | 16,2 mm |
| depth | 10,8 mm |
| type | rectangular |
| housing material | plastic (PMMA, MABS, PA) |
| front (optics) | PMMA |

ambient conditions

| | |
|-----------------------|----------------|
| operating temperature | -20 ... +50 °C |
| protection class | IP 65 |

connection diagrams

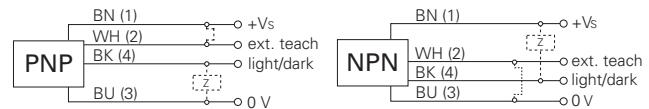

connectors

| | | |
|--------------|-------|--------------|
| ESG 32AH0200 | 4 pin | 2 m straight |
| ESW 31AH0200 | 4 pin | 2 m angular |

additional cable connectors and field wireable connectors, see accessories

accessories

| | |
|----------------------|--------|
| MINOFIX mounting kit | 150844 |
|----------------------|--------|

for details, see accessories section

| order reference | connection types | output circuit |
|--------------------|-----------------------------|----------------|
| FHCK 07N6901 | cable rear side | NPN |
| FHCK 07N6901/KS35A | flylead connector M8, 4 pin | NPN |
| FHCK 07P6901 | cable rear side | PNP |
| FHCK 07P6901/KS35A | flylead connector M8, 4 pin | PNP |

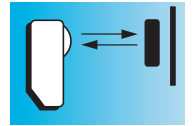

sensing distance diagram

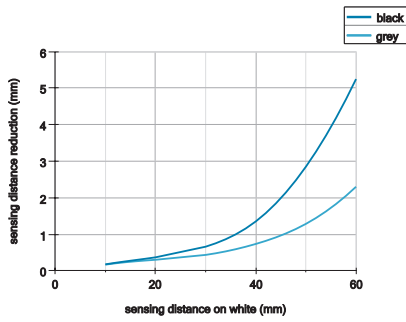

dimension drawings

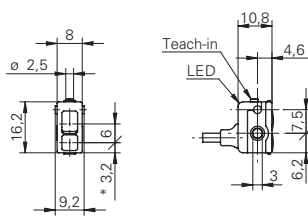

* emitter axis

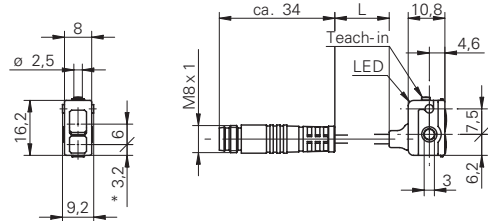

* emitter axis cable length L = 200 mm

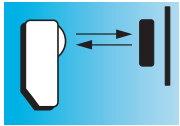

$T_w = 10 \dots 60 \text{ mm}$

- ultra compact housing
- sensing distance adjustable via Teach-in
- suppression of mutual optical interference



general data

| | |
|-------------------------------------|--------------------------|
| type | background suppression |
| light source | pulsed red LED |
| sensing distance T_w | 10 ... 60 mm |
| sensing range T_b (at T_w max.) | 2 ... 60 mm |
| sensing range T_b (at T_w min.) | 5 ... 10 mm |
| alignment / soiled lens indicator | flashing light indicator |
| light indicator | LED green |
| output indicator | LED yellow |
| sensing distance adjustment | Teach-in |
| wave length | 660 nm |
| suppression of reciprocal influence | yes |

electrical data

| | |
|------------------------------|----------------------|
| response time / release time | < 0,5 ms |
| voltage supply range +Vs | 10 ... 30 VDC |
| current consumption max. | 25 mA |
| current consumption typ. | 20 mA |
| voltage drop V_d | < 1,8 VDC |
| output function | light / dark operate |
| output current | < 100 mA |
| short circuit protection | yes |
| reverse polarity protection | yes |

mechanical data

| | |
|------------------|--------------------------|
| width / diameter | 8 mm |
| height / length | 16,2 mm |
| depth | 10,8 mm |
| type | rectangular |
| housing material | plastic (PMMA, MABS, PA) |
| front (optics) | PMMA |

ambient conditions

| | |
|-----------------------|----------------|
| operating temperature | -20 ... +50 °C |
| protection class | IP 65 |

connection diagrams

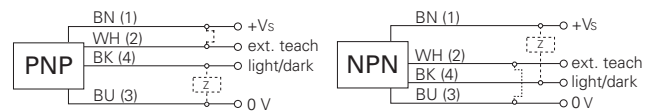

connectors

| | | |
|--------------|-------|--------------|
| ESG 32AH0200 | 4 pin | 2 m straight |
| ESW 31AH0200 | 4 pin | 2 m angular |

additional cable connectors and field wireable connectors, see accessories

accessories

| | |
|----------------------|--------|
| MINOFIX mounting kit | 150844 |
|----------------------|--------|

for details, see accessories section

| order reference | connection types | output circuit |
|--------------------|-----------------------------|----------------|
| FHDK 07N6901 | cable bottom side | NPN |
| FHDK 07N6901/KS35A | flylead connector M8, 4 pin | NPN |
| FHDK 07P6901 | cable bottom side | PNP |
| FHDK 07P6901/KS35A | flylead connector M8, 4 pin | PNP |

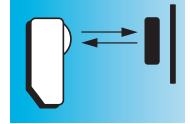

sensing distance diagram

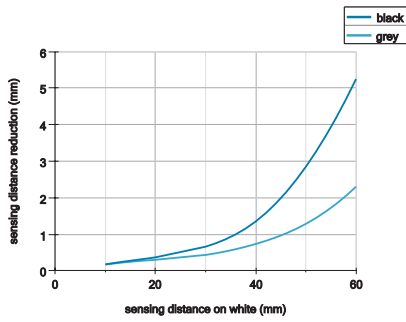

dimension drawings

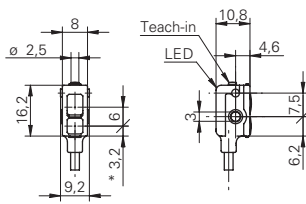

* emitter axis

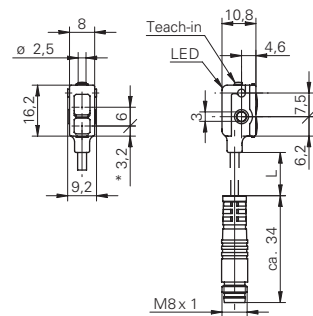

* emitter axis cable length L = 200 mm

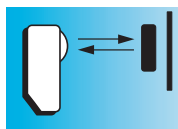

Tw = 80 mm

- subminiature housing
- fixed sensing distance
- push-pull output



general data

| | |
|-------------------------------------|--------------------------|
| type | background suppression |
| light source | pulsed red LED |
| alignment / soiled lens indicator | flashing light indicator |
| light indicator | LED yellow |
| wave length | 660 nm |
| suppression of reciprocal influence | yes |

electrical data

| | |
|------------------------------|----------------------|
| response time / release time | < 1 ms |
| voltage supply range +Vs | 10 ... 30 VDC |
| current consumption max. | 25 mA |
| current consumption typ. | 18 mA |
| voltage drop Vd | < 1,8 VDC |
| output function | light / dark operate |
| output circuit | push-pull |
| output current | < 50 mA |
| short circuit protection | yes |
| reverse polarity protection | yes |

mechanical data

| | |
|------------------|---------------|
| width / diameter | 10,4 mm |
| height / length | 27 mm |
| depth | 14,7 mm |
| type | rectangular |
| housing material | plastic (ASA) |
| front (optics) | PMMA |

ambient conditions

| | |
|-----------------------|----------------|
| operating temperature | -25 ... +65 °C |
|-----------------------|----------------|

connection diagram

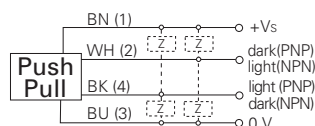

connectors

| | | |
|--------------|-------|--------------|
| ESG 32AH0200 | 4 pin | 2 m straight |
| ESW 31AH0200 | 4 pin | 2 m angular |

additional cable connectors and field wireable connectors, see accessories

accessories

| | |
|-----------------------------------|--------|
| SENSOFIX mounting kit | 150326 |
| mounting bracket (cable type) | 114501 |
| mounting bracket (connector type) | 133792 |

for details, see accessories section

| order reference | sensing distance Tw | connection types | protection class |
|-------------------|---------------------|---------------------|------------------|
| FHDK 10G5120 | 30 mm ±2 mm | cable 4 pin | IP 65 |
| FHDK 10G5120/S35A | 30 mm ±2 mm | connector M8, 4 pin | IP 67 |
| FHDK 10G5121 | 50 mm ±3 mm | cable 4 pin | IP 65 |
| FHDK 10G5121/S35A | 50 mm ±3 mm | connector M8, 4 pin | IP 67 |
| FHDK 10G5122 | 80 mm ±8 mm | cable 4 pin | IP 65 |
| FHDK 10G5122/S35A | 80 mm ±8 mm | connector M8, 4 pin | IP 67 |

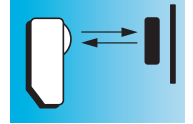

sensing distance diagram

Tw = 30 mm ±2 mm

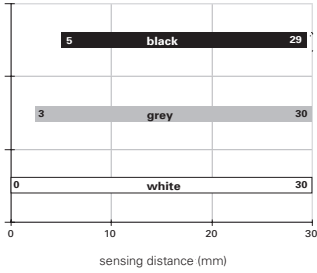

Tw = 50 mm ±3 mm

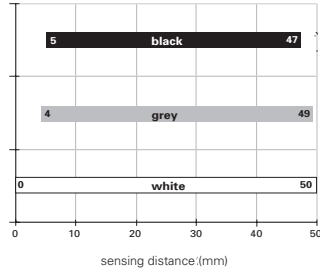

Tw = 80 mm ±8 mm

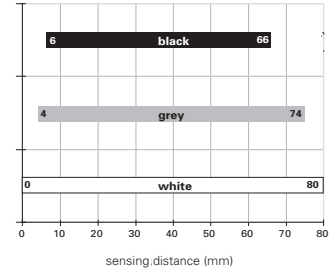

dimension drawings

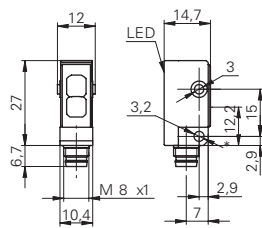

* emitter axis

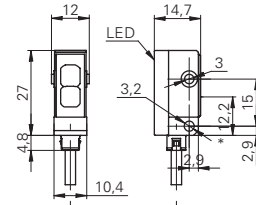

* emitter axis

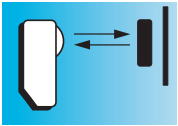

Tw = 20 ... 120 mm

- subminiature housing
- large sensing range
- sensing distance adjustable via potentiometer



general data

| | |
|-------------------------------------|--------------------------|
| type | background suppression |
| sensing distance Tw | 20 ... 120 mm |
| sensing range Tb (at Tw max.) | 5 ... 120 mm |
| sensing range Tb (at Tw min.) | 5 ... 20 mm |
| alignment / soiled lens indicator | flashing light indicator |
| light indicator | LED yellow |
| sensing distance adjustment | mechanical, 5 turn |
| wave length | 660 nm |
| suppression of reciprocal influence | yes |

electrical data

| | |
|------------------------------|---------------|
| response time / release time | < 1 ms |
| voltage supply range +Vs | 10 ... 30 VDC |
| current consumption max. | 30 mA |
| current consumption typ. | 20 mA |
| voltage drop Vd | < 1,8 VDC |
| output current | < 100 mA |
| short circuit protection | yes |
| reverse polarity protection | yes |

mechanical data

| | |
|------------------|---------------|
| width / diameter | 10,4 mm |
| height / length | 27 mm |
| depth | 14 mm |
| type | rectangular |
| housing material | plastic (ASA) |
| front (optics) | PMMA |

ambient conditions

| | |
|-----------------------|----------------|
| operating temperature | -25 ... +65 °C |
|-----------------------|----------------|

connection diagrams

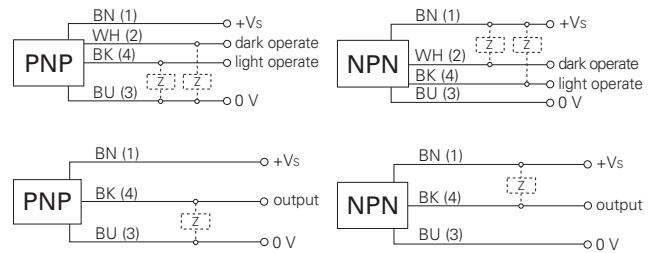

connectors

| | | |
|--------------|-------|--------------|
| ESG 32SH0200 | 3 pin | 2 m straight |
| ESW 31SH0200 | 3 pin | 2 m angular |
| ESG 32AH0200 | 4 pin | 2 m straight |
| ESW 31AH0200 | 4 pin | 2 m angular |

additional cable connectors and field wireable connectors, see accessories

accessories

| | |
|-----------------------------------|--------|
| SENSOFIX mounting kit | 150326 |
| mounting bracket (cable type) | 114501 |
| mounting bracket (connector type) | 133792 |

for details, see accessories section

| order reference | connection types | output circuit | output function | light source | beam diameter | protection class |
|-------------------|-----------------------------|----------------|----------------------|-------------------------|---------------|------------------|
| FHDK 10N1101/KS35 | flylead connector M8, 3 pin | NPN | light operate | pulsed red LED | 4 mm | IP 65 |
| FHDK 10N5101 | cable 4 pin | NPN | light / dark operate | pulsed red LED | 4 mm | IP 65 |
| FHDK 10N5101/S35A | connector M8, 4 pin | NPN | light / dark operate | pulsed red LED | 4 mm | IP 67 |
| FHDK 10N5110 | cable 4 pin | NPN | light / dark operate | pulsed point source LED | 2 mm | IP 65 |
| FHDK 10N5110/S35A | connector M8, 4 pin | NPN | light / dark operate | pulsed point source LED | 2 mm | IP 67 |
| FHDK 10P1101/KS35 | flylead connector M8, 3 pin | PNP | light operate | pulsed red LED | 4 mm | IP 65 |
| FHDK 10P5101 | cable 4 pin | PNP | light / dark operate | pulsed red LED | 4 mm | IP 65 |
| FHDK 10P5101/S35A | connector M8, 4 pin | PNP | light / dark operate | pulsed red LED | 4 mm | IP 67 |
| FHDK 10P5110 | cable 4 pin | PNP | light / dark operate | pulsed point source LED | 2 mm | IP 65 |

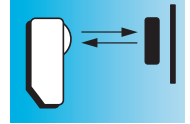

sensing distance diagram

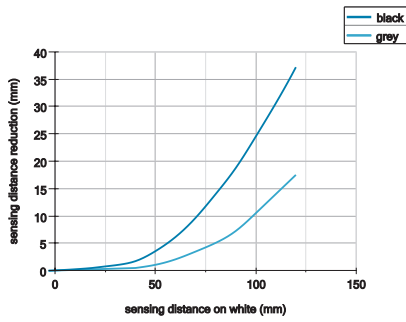

dimension drawings

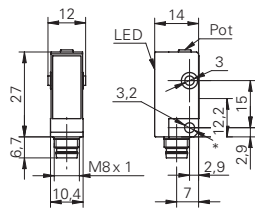

* emitter axis

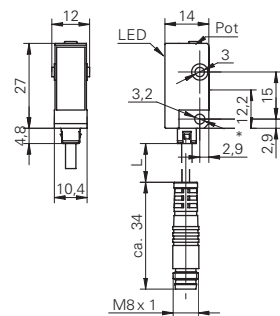

* emitter axis cable length L = 200 mm

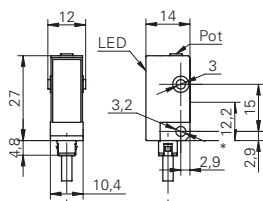

* emitter axis

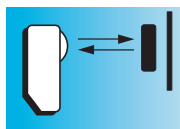

$T_w = 20 \dots 80 \text{ mm}$

- subminiature housing
- with line beam
- sensing distance adjustable via potentiometer



general data

| | |
|-------------------------------------|--------------------------|
| type | background suppression |
| version | line beam |
| light source | pulsed red LED |
| sensing distance T_w | 20 ... 80 mm |
| sensing range T_b (at T_w max.) | 5 ... 80 mm |
| sensing range T_b (at T_w min.) | 5 ... 20 mm |
| alignment / soiled lens indicator | flashing light indicator |
| light indicator | LED yellow |
| sensing distance adjustment | mechanical, 5 turn |
| wave length | 660 nm |
| suppression of reciprocal influence | yes |

electrical data

| | |
|------------------------------|----------------------|
| response time / release time | < 1 ms |
| voltage supply range +Vs | 10 ... 30 VDC |
| current consumption max. | 30 mA |
| current consumption typ. | 20 mA |
| voltage drop Vd | < 1,8 VDC |
| output function | light / dark operate |
| output current | < 100 mA |
| short circuit protection | yes |
| reverse polarity protection | yes |

mechanical data

| | |
|------------------|---------------|
| width / diameter | 10,4 mm |
| height / length | 27 mm |
| depth | 14 mm |
| type | rectangular |
| housing material | plastic (ASA) |
| front (optics) | PMMA |

ambient conditions

| | |
|-----------------------|----------------|
| operating temperature | -25 ... +65 °C |
|-----------------------|----------------|

connection diagrams

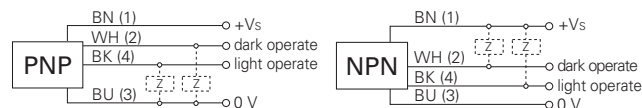

connectors

| | | |
|--------------|-------|--------------|
| ESG 32AH0200 | 4 pin | 2 m straight |
| ESW 31AH0200 | 4 pin | 2 m angular |

additional cable connectors and field wireable connectors, see accessories

accessories

| | |
|-----------------------------------|--------|
| SENSOFIX mounting kit | 150326 |
| mounting bracket (cable type) | 114501 |
| mounting bracket (connector type) | 133792 |

for details, see accessories section

| order reference | connection types | output circuit | protection class |
|-------------------|---------------------|----------------|------------------|
| FHDK 10N5150 | cable 4 pin | NPN | IP 65 |
| FHDK 10N5150/S35A | connector M8, 4 pin | NPN | IP 67 |
| FHDK 10P5150 | cable 4 pin | PNP | IP 65 |
| FHDK 10P5150/S35A | connector M8, 4 pin | PNP | IP 67 |

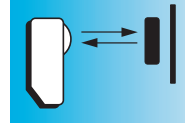

beam characteristic

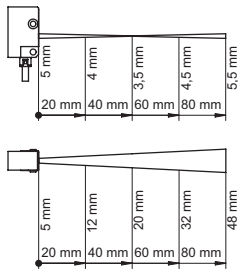

dimension drawings

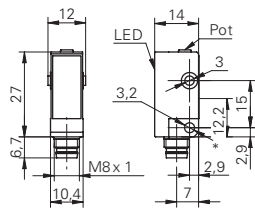

* emitter axis

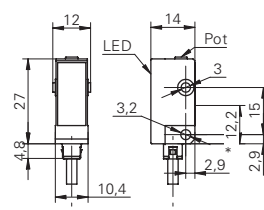

* emitter axis

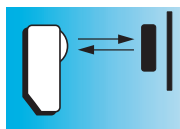

$T_w = 10 \dots 30 \text{ mm}$

- subminiature housing
- optimized for glass detection
- sensing distance adjustable via potentiometer



general data

| | |
|-------------------------------------|--------------------------|
| type | background suppression |
| special type | for glass detection |
| light source | pulsed red LED |
| sensing distance T_w | 10 ... 30 mm |
| sensing range T_b (at T_w max.) | 3 ... 30 mm |
| alignment / soiled lens indicator | flashing light indicator |
| light indicator | LED yellow |
| sensing distance adjustment | mechanical, 5 turn |
| wave length | 660 nm |
| suppression of reciprocal influence | yes |

electrical data

| | |
|------------------------------|----------------------|
| response time / release time | < 1 ms |
| voltage supply range +Vs | 10 ... 30 VDC |
| current consumption max. | 30 mA |
| current consumption typ. | 20 mA |
| voltage drop Vd | < 1,8 VDC |
| output function | light / dark operate |
| output current | < 100 mA |
| short circuit protection | yes |
| reverse polarity protection | yes |

mechanical data

| | |
|------------------|---------------------|
| width / diameter | 10,4 mm |
| height / length | 27 mm |
| depth | 14 mm |
| type | rectangular |
| housing material | plastic (ASA) |
| front (optics) | PMMA |
| connection types | connector M8, 4 pin |

ambient conditions

| | |
|-----------------------|----------------|
| operating temperature | -25 ... +65 °C |
| protection class | IP 67 |

order reference

| order reference | output circuit |
|-------------------|----------------|
| FHDK 10N5160/S35A | NPN |
| FHDK 10P5160/S35A | PNP |

connection diagrams

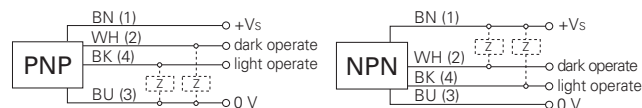

connectors

| | | |
|--------------|-------|--------------|
| ESG 32AH0200 | 4 pin | 2 m straight |
| ESW 31AH0200 | 4 pin | 2 m angular |

additional cable connectors and field wireable connectors, see accessories

accessories

| | |
|-----------------------|--------|
| SENSOFIX mounting kit | 150326 |
| mounting bracket | 133792 |

for details, see accessories section

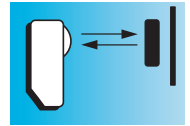

sensing distance diagram

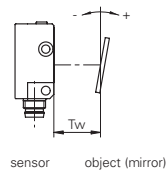
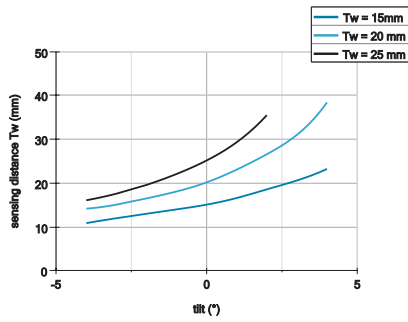

dimension drawing

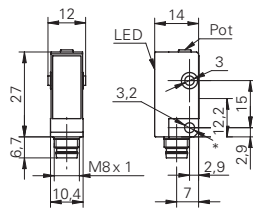

* emitter axis

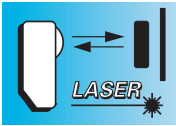

Tw = 22 ... 130 mm

- subminiature housing
- high repeatability
- sensing distance adjustable via potentiometer



general data

| | |
|-------------------------------|-------------------------|
| type | background suppression |
| light source | pulsed red laser diode |
| sensing distance Tw | 22 ... 130 mm |
| sensing range Tb (at Tw max.) | 3 ... 130 mm |
| sensing range Tb (at Tw min.) | 3 ... 22 mm |
| repeatability | < 0,2 mm at laser focus |
| light indicator | LED yellow |
| power on indication | LED green |
| sensing distance adjustment | mechanical, 5 turn |
| laser class | 2 |
| distance to laser focus | 40 mm |
| wave length | 675 nm |

electrical data

| | |
|------------------------------|----------------------|
| response time / release time | < 0,25 ms |
| voltage supply range +Vs | 10 ... 30 VDC |
| current consumption max. | 50 mA |
| current consumption typ. | 40 mA |
| voltage drop Vd | < 1,8 VDC |
| output function | light / dark operate |
| output current | < 100 mA |
| short circuit protection | yes |
| reverse polarity protection | yes |

mechanical data

| | |
|------------------|---------------|
| width / diameter | 10,4 mm |
| height / length | 27 mm |
| depth | 16,3 mm |
| type | rectangular |
| housing material | plastic (ASA) |
| front (optics) | PMMA |

ambient conditions

| | |
|-----------------------|----------------|
| operating temperature | -10 ... +50 °C |
|-----------------------|----------------|

connection diagrams

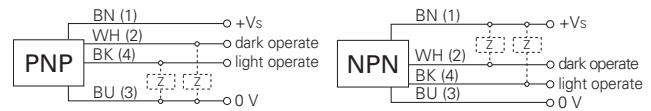

connectors

| | | |
|--------------|-------|--------------|
| ESG 32AH0200 | 4 pin | 2 m straight |
| ESW 31AH0200 | 4 pin | 2 m angular |

additional cable connectors and field wireable connectors, see accessories

accessories

| | |
|-----------------------------------|--------|
| SENSOFIX mounting kit | 150326 |
| mounting bracket (cable type) | 114501 |
| mounting bracket (connector type) | 133792 |

for details, see accessories section

laser warning



| order reference | connection types | output circuit | protection class |
|-------------------|---------------------|----------------|------------------|
| OHDK 10N5101 | cable 4 pin | NPN | IP 65 |
| OHDK 10N5101/S35A | connector M8, 4 pin | NPN | IP 67 |
| OHDK 10P5101 | cable 4 pin | PNP | IP 65 |
| OHDK 10P5101/S35A | connector M8, 4 pin | PNP | IP 67 |

OHDK 10 Tw = 22 ... 130 mm

Diffuse sensors with background suppression

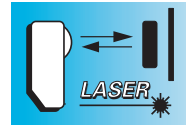

sensing distance diagram

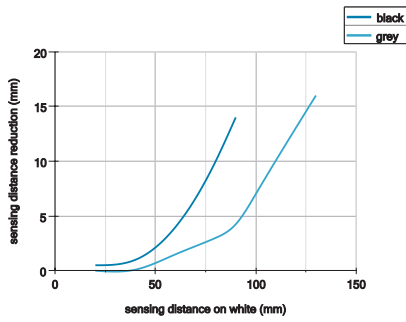

beam characteristic

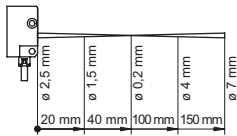

dimension drawings

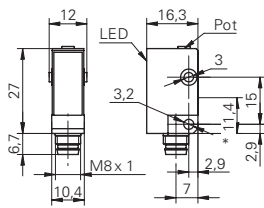

* emitter axis

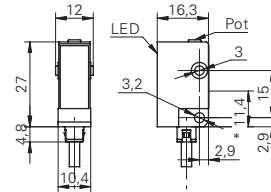

* emitter axis

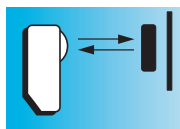

Tw = 15 ... 300 mm

- rugged miniature metal housing
- sensing distance adjustable via potentiometer
- suppression of mutual optical interference



general data

| | |
|-------------------------------------|------------------------|
| type | background suppression |
| light source | pulsed red LED |
| sensing distance Tw | 15 ... 300 mm |
| sensing range Tb (at Tw max.) | 15 ... 300 mm |
| sensing range Tb (at Tw min.) | 5 ... 15 mm |
| light indicator | LED yellow |
| sensing distance adjustment | mechanical, 5 turn |
| wave length | 660 nm |
| suppression of reciprocal influence | yes |

electrical data

| | |
|------------------------------|----------------------|
| response time / release time | < 1 ms |
| voltage supply range +Vs | 10 ... 30 VDC |
| current consumption max. | 35 mA |
| current consumption typ. | 25 mA |
| voltage drop Vd | < 1,8 VDC |
| output function | light / dark operate |
| output current | < 100 mA |
| short circuit protection | yes |
| reverse polarity protection | yes |

mechanical data

| | |
|------------------|---------------|
| width / diameter | 12,4 mm |
| height / length | 35 mm |
| depth | 35 mm |
| type | rectangular |
| housing material | die-cast zinc |
| front (optics) | PMMA |

ambient conditions

| | |
|-----------------------|----------------|
| operating temperature | -25 ... +65 °C |
| protection class | IP 67 |

connection diagrams



connectors

| | | |
|--------------|-------|--------------|
| ESG 32AH0200 | 4 pin | 2 m straight |
| ESW 31AH0200 | 4 pin | 2 m angular |

additional cable connectors and field wireable connectors, see accessories

accessories

| | |
|-----------------------|--------|
| SENSOFIX mounting kit | 150328 |
| mounting bracket | 113873 |

for details, see accessories section

| order reference | connection types | output circuit |
|-------------------|---------------------|----------------|
| FHDM 12N5001 | cable 4 pin | NPN |
| FHDM 12N5001/S35A | connector M8, 4 pin | NPN |
| FHDM 12P5001 | cable 4 pin | PNP |
| FHDM 12P5001/S35A | connector M8, 4 pin | PNP |

FHDM 12 Tw = 15 ... 300 mm

Diffuse sensors with background suppression

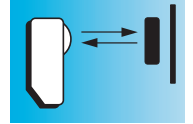

sensing distance diagram

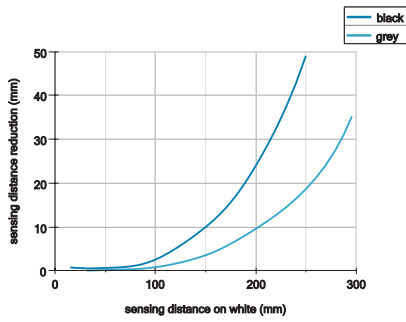

dimension drawings

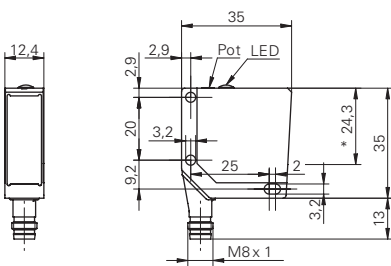

* emitter axis

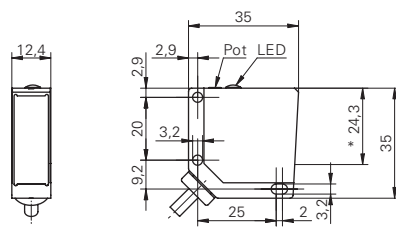

* emitter axis

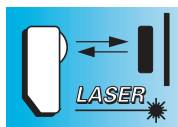

Tw = 17 ... 120 mm



- rugged miniature metal housing
- negligible black/white difference
- teachable sensing distance



general data

| | |
|-------------------------------|------------------------|
| type | background suppression |
| light source | pulsed red laser diode |
| sensing distance Tw | 17 ... 120 mm |
| sensing range Tb (at Tw max.) | 16 ... 120 mm |
| sensing range Tb (at Tw min.) | 16 ... 17 mm |
| light indicator | LED red |
| power on indication | LED green |
| sensing distance adjustment | Teach-in |
| laser class | 2 |
| beam diameter | 0,9 ... 0,5 mm |
| wave length | 675 nm |

electrical data

| | |
|-----------------------------|----------------------|
| response time | < 1 ms |
| release time | < 2,7 ms |
| voltage supply range +Vs | 12 ... 28 VDC |
| current consumption max. | 80 mA |
| current consumption typ. | 40 mA |
| voltage drop Vd | < 2,8 VDC |
| output function | light / dark operate |
| output current | < 100 mA |
| short circuit protection | yes |
| reverse polarity protection | yes, Vs to GND |

mechanical data

| | |
|------------------|---------------------|
| width / diameter | 12,4 mm |
| height / length | 37 mm |
| depth | 34,5 mm |
| type | rectangular |
| housing material | die-cast zinc |
| front (optics) | glass |
| connection types | connector M8, 4 pin |

ambient conditions

| | |
|-----------------------|--------------|
| operating temperature | 0 ... +50 °C |
| protection class | IP 67 |

order reference output circuit

| | |
|-------------------|-----|
| OHDM 12N6901/S35A | NPN |
| OHDM 12P6901/S35A | PNP |

connection diagrams

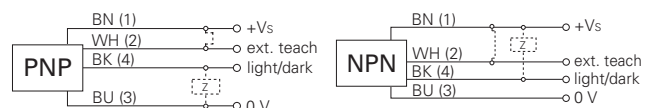

connectors

| | | |
|--------------|-------|--------------|
| ESG 32AH0200 | 4 pin | 2 m straight |
| ESW 31AH0200 | 4 pin | 2 m angular |

additional cable connectors and field wireable connectors, see accessories

accessories

| | |
|-----------------------|--------|
| SENSOFIX mounting kit | 150328 |
| mounting bracket | 113873 |

for details, see accessories section

laser warning

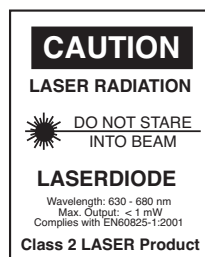

OHDM 12 Tw = 17 ... 120 mm

Diffuse sensors with background suppression

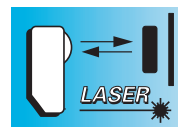

sensing distance diagram

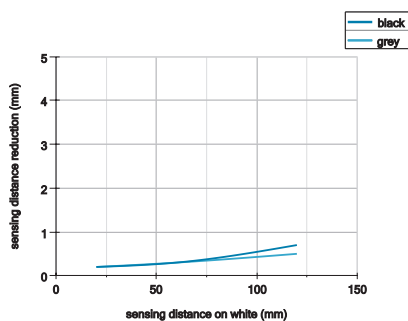

dimension drawing

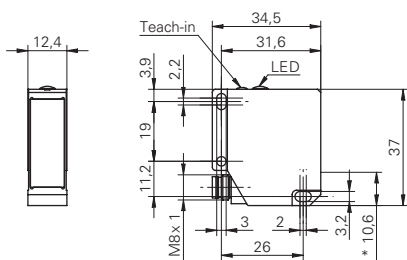

* emitter axis

OHDM 12 Tw = 17 ... 120 mm

Diffuse sensors with background suppression

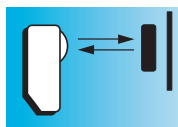

Tw = 20 ... 500 mm



- long sensing range
- sensing distance adjustable via potentiometer
- suppression of mutual opt. interference

general data

| | |
|-------------------------------------|--------------------------|
| type | background suppression |
| light source | pulsed red LED |
| alignment / soiled lens indicator | flashing light indicator |
| light indicator | LED yellow |
| sensing distance adjustment | mechanical, 10 turn |
| wave length | 660 nm |
| suppression of reciprocal influence | yes |

sensing distance Tw = 20 ... 350 mm

| | |
|-------------------------------|---------------|
| sensing range Tb (at Tw max.) | 20 ... 350 mm |
| sensing range Tb (at Tw min.) | 5 ... 20 mm |

sensing distance Tw = 30 ... 500 mm

| | |
|-------------------------------|---------------|
| sensing range Tb (at Tw max.) | 30 ... 500 mm |
| sensing range Tb (at Tw min.) | 5 ... 30 mm |

electrical data

| | |
|-----------------------------|----------------------|
| voltage supply range +Vs | 10 ... 30 VDC |
| current consumption max. | 30 mA |
| current consumption typ. | 25 mA |
| voltage drop Vd | < 1,8 VDC |
| output function | light / dark operate |
| output current | < 100 mA |
| short circuit protection | yes |
| reverse polarity protection | yes |

mechanical data

| | |
|------------------|---------------------|
| width / diameter | 14,8 mm |
| height / length | 43 mm |
| depth | 31 mm |
| type | rectangular |
| housing material | plastic (PA12) |
| front (optics) | PA |
| connection types | connector M8, 4 pin |

ambient conditions

| | |
|-----------------------|----------------|
| operating temperature | -25 ... +65 °C |
| protection class | IP 67 |

connection diagrams



connectors

| | | |
|--------------|-------|--------------|
| ESG 32AH0200 | 4 pin | 2 m straight |
| ESW 31AH0200 | 4 pin | 2 m angular |

additional cable connectors and field wireable connectors, see accessories

accessories

| | |
|-----------------------|--------|
| SENSOFIX mounting kit | 149011 |
| mounting bracket | 134964 |

for details, see accessories section

| order reference | sensing distance Tw | output circuit | response time / release time |
|-------------------|---------------------|----------------|------------------------------|
| FHDK 14N5101/S35A | 20 ... 350 mm | NPN | < 1 ms |
| FHDK 14N5104/S35A | 30 ... 500 mm | NPN | < 5 ms |
| FHDK 14P5101/S35A | 20 ... 350 mm | PNP | < 1 ms |
| FHDK 14P5104/S35A | 30 ... 500 mm | PNP | < 5 ms |

FHDK 14 Tw = 20 ... 500 mm

Diffuse sensors with background suppression

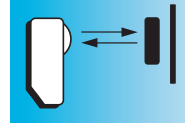

sensing distance diagram

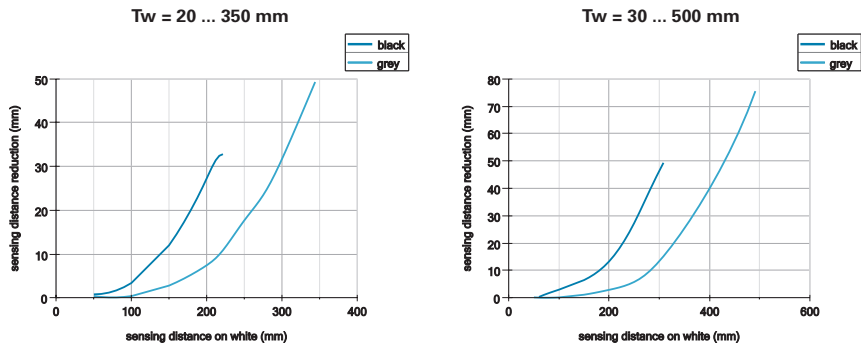

dimension drawing

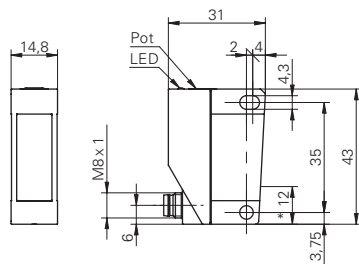

* emitter axis

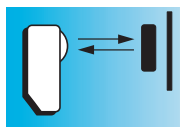

$T_w = 40 \dots 200 \text{ mm}$

IO-Link

- short response time
- sensing distance adjustable via Teach-in
- suppression of mutual optical interference



general data

| | |
|-------------------------------------|--------------------------|
| type | background suppression |
| light source | pulsed red LED |
| sensing distance T_w | 40 ... 200 mm |
| sensing range T_b (at T_w max.) | 2 ... 200 mm |
| sensing range T_b (at T_w min.) | 12 ... 40 mm |
| alignment / soiled lens indicator | flashing light indicator |
| light indicator | LED green |
| output indicator | LED yellow |
| sensing distance adjustment | Teach-in |
| wave length | 660 nm |
| suppression of reciprocal influence | yes |

electrical data

| | |
|------------------------------|----------------------|
| response time / release time | < 0,5 ms |
| voltage supply range +Vs | 10 ... 30 VDC |
| current consumption max. | 40 mA |
| current consumption typ. | 35 mA |
| voltage drop V_d | < 1,8 VDC |
| output function | light / dark operate |
| output current | < 100 mA |
| short circuit protection | yes |
| reverse polarity protection | yes |

mechanical data

| | |
|------------------|---------------------|
| width / diameter | 14,8 mm |
| height / length | 43 mm |
| depth | 31 mm |
| type | rectangular |
| housing material | plastic (PA12) |
| front (optics) | PA |
| connection types | connector M8, 4 pin |

ambient conditions

| | |
|-----------------------|----------------|
| operating temperature | -25 ... +65 °C |
| protection class | IP 67 |

order reference

| order reference | output circuit |
|-------------------|----------------|
| FHDK 14N6901/S35A | NPN |
| FHDK 14P6901/S35A | PNP |

connection diagrams



connectors

| | | |
|--------------|-------|--------------|
| ESG 32AH0200 | 4 pin | 2 m straight |
| ESW 31AH0200 | 4 pin | 2 m angular |

additional cable connectors and field wireable connectors, see accessories

accessories

| | |
|-----------------------|--------|
| SENSOFIX mounting kit | 149011 |
| mounting bracket | 134964 |

for details, see accessories section

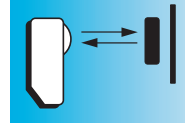

sensing distance diagram

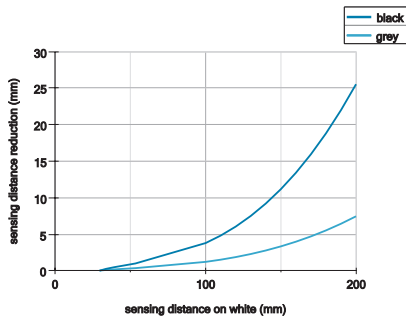

dimension drawing

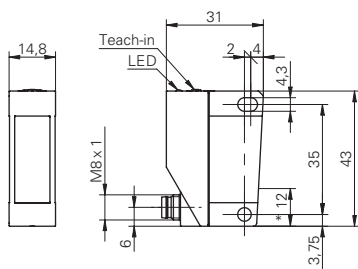

* emitter axis

FHDK 14 Tw = 40 ... 200 mm

Diffuse sensors with background suppression

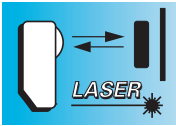

Tw = 20 ... 350 mm



- short response time
- high repeatability
- sensing distance adjustable via potentiometer

general data

| | |
|-------------------------------|-------------------------|
| type | background suppression |
| light source | pulsed red laser diode |
| sensing distance Tw | 20 ... 350 mm |
| sensing range Tb (at Tw max.) | 20 ... 350 mm |
| sensing range Tb (at Tw min.) | 5 ... 20 mm |
| repeatability | < 0,2 mm at laser focus |
| light indicator | LED yellow |
| power on indication | LED green |
| sensing distance adjustment | mechanical, 9 turn |
| laser class | 2 |
| distance to laser focus | 115 mm |
| wave length | 650 nm |

electrical data

| | |
|------------------------------|----------------------|
| response time / release time | < 0,5 ms |
| voltage supply range +Vs | 10 ... 30 VDC |
| current consumption max. | 35 mA |
| current consumption typ. | 25 mA |
| voltage drop Vd | < 2,2 VDC |
| output function | light / dark operate |
| output current | < 100 mA |
| short circuit protection | yes |
| reverse polarity protection | yes |

mechanical data

| | |
|------------------|---------------------|
| width / diameter | 14,8 mm |
| height / length | 43 mm |
| depth | 31 mm |
| type | rectangular |
| housing material | plastic (PA12) |
| front (optics) | PA |
| connection types | connector M8, 4 pin |

ambient conditions

| | |
|-----------------------|----------------|
| operating temperature | -10 ... +50 °C |
| protection class | IP 67 |

order reference output circuit

| | |
|-------------------|-----|
| OHDK 14N5101/S35A | NPN |
| OHDK 14P5101/S35A | PNP |

connection diagrams

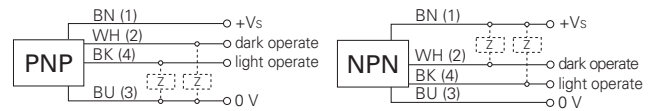

connectors

| | | |
|--------------|-------|--------------|
| ESG 32AH0200 | 4 pin | 2 m straight |
| ESW 31AH0200 | 4 pin | 2 m angular |

additional cable connectors and field wireable connectors, see accessories

accessories

| | |
|-----------------------|--------|
| SENSOFIX mounting kit | 149011 |
| mounting bracket | 134964 |

for details, see accessories section

laser warning



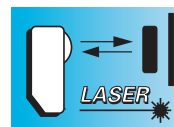

sensing distance diagram

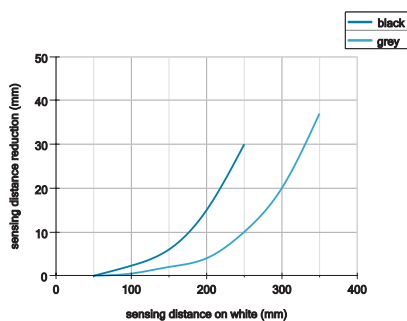

beam characteristic

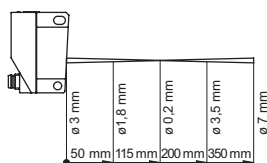

dimension drawing

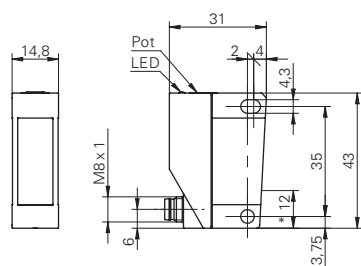

* emitter axis

OHDK 14 Tw = 20 ... 350 mm

Diffuse sensors with background suppression

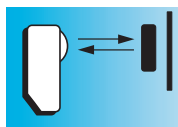

Tw = 20 ... 600 mm

- rugged metal housing
- sensing distance adjustable via potentiometer
- suppression of mutual optical interference



general data

| | |
|-------------------------------------|------------------------|
| type | background suppression |
| light source | pulsed red LED |
| sensing range Tb (at Tw min.) | 5 ... 20 mm |
| light indicator | LED yellow |
| sensing distance adjustment | mechanical, 5 turn |
| wave length | 660 nm |
| suppression of reciprocal influence | yes |

sensing distance Tw = 20 ... 450 mm

| | |
|-------------------------------|---------------|
| sensing range Tb (at Tw max.) | 20 ... 450 mm |
|-------------------------------|---------------|

sensing distance Tw = 20 ... 600 mm

| | |
|-------------------------------|---------------|
| sensing range Tb (at Tw max.) | 20 ... 600 mm |
|-------------------------------|---------------|

electrical data

| | |
|-----------------------------|----------------------|
| voltage supply range +Vs | 10 ... 30 VDC |
| current consumption max. | 41 mA |
| current consumption typ. | 29 mA |
| voltage drop Vd | < 1,8 VDC |
| output function | light / dark operate |
| output current | < 200 mA |
| short circuit protection | yes |
| reverse polarity protection | yes |

mechanical data

| | |
|------------------|---------------|
| width / diameter | 15,4 mm |
| height / length | 50 mm |
| depth | 50 mm |
| type | rectangular |
| housing material | die-cast zinc |
| front (optics) | PMMA |

ambient conditions

| | |
|-----------------------|----------------|
| operating temperature | -25 ... +65 °C |
| protection class | IP 67 |

connection diagrams



connectors

| | | |
|--------------|-------|--------------|
| ESG 34AH0200 | 4 pin | 2 m straight |
| ESW 33AH0200 | 4 pin | 2 m angular |

additional cable connectors and field wireable connectors, see accessories

accessories

| | |
|-----------------------|--------|
| SENSOFIX mounting kit | 151721 |
| mounting bracket | 113917 |

for details, see accessories section

| order reference | sensing distance Tw | connection types | output circuit | response time / release time |
|------------------|---------------------|----------------------|----------------|------------------------------|
| FHDM 16N5001 | 20 ... 450 mm | cable 4 pin | NPN | < 1 ms |
| FHDM 16N5001/S14 | 20 ... 450 mm | connector M12, 4 pin | NPN | < 1 ms |
| FHDM 16N5004 | 20 ... 600 mm | cable 4 pin | NPN | < 5 ms |
| FHDM 16N5004/S14 | 20 ... 600 mm | connector M12, 4 pin | NPN | < 5 ms |
| FHDM 16P5001 | 20 ... 450 mm | cable 4 pin | PNP | < 1 ms |
| FHDM 16P5001/S14 | 20 ... 450 mm | connector M12, 4 pin | PNP | < 1 ms |
| FHDM 16P5004/S14 | 20 ... 600 mm | connector M12, 4 pin | PNP | < 5 ms |
| FHDM 16P5004 | 20 ... 600 mm | cable 4 pin | PNP | < 5 ms |

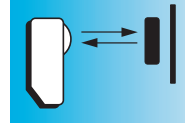

sensing distance diagram

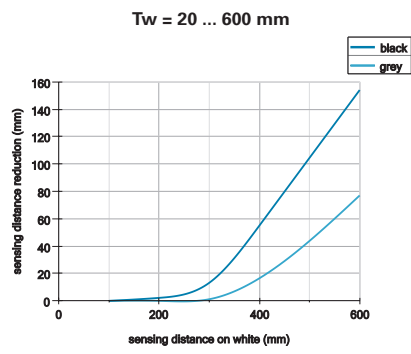
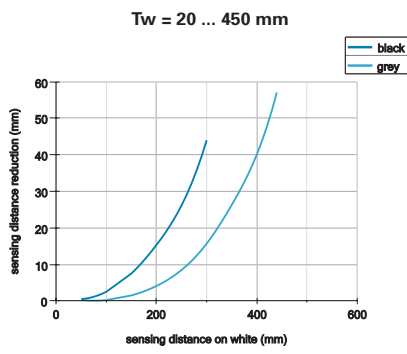

dimension drawings

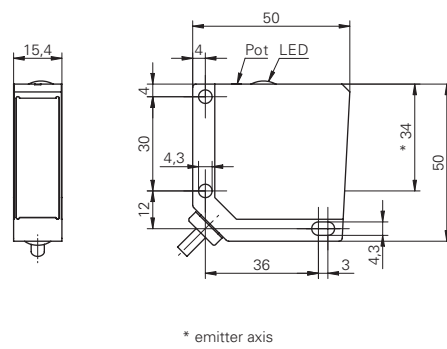
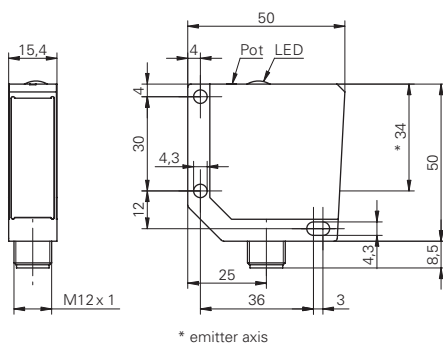

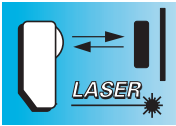

Tw = 25 ... 300 mm

- rugged metal housing
- long sensing range
- high repeatability



general data

| | |
|-------------------------------|-------------------------|
| type | background suppression |
| light source | pulsed red laser diode |
| sensing distance Tw | 25 ... 300 mm |
| sensing range Tb (at Tw max.) | 40 ... 300 mm |
| sensing range Tb (at Tw min.) | 5 ... 25 mm |
| repeatability | < 0,1 mm at laser focus |
| output indicator | LED yellow |
| sensing distance adjustment | mechanical, 8 turn |
| laser class | 2 |

electrical data

| | |
|-----------------------------|----------------------|
| voltage supply range +Vs | 10 ... 30 VDC |
| current consumption max. | 35 mA |
| current consumption typ. | 25 mA |
| voltage drop Vd | < 1,8 VDC |
| output function | light / dark operate |
| output current | < 200 mA |
| short circuit protection | yes |
| reverse polarity protection | yes |

mechanical data

| | |
|------------------|---------------|
| width / diameter | 15,4 mm |
| height / length | 50 mm |
| depth | 50 mm |
| type | rectangular |
| housing material | die-cast zinc |
| front (optics) | glass |

ambient conditions

| | |
|-----------------------|----------------|
| operating temperature | -10 ... +50 °C |
| protection class | IP 67 |

connection diagrams

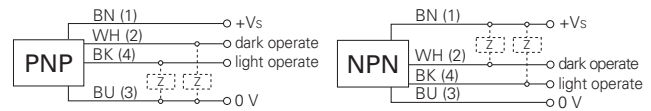

connectors

| | | |
|--------------|-------|--------------|
| ESG 34AH0200 | 4 pin | 2 m straight |
| ESW 33AH0200 | 4 pin | 2 m angular |

additional cable connectors and field wireable connectors, see accessories

accessories

| | |
|----------------------------------|--------|
| SENSOFIX mounting kit | 151721 |
| mounting bracket | 113917 |
| lens cleaning air nozzle bracket | 116407 |

for details, see accessories section

laser warning



| order reference | connection types | output circuit | response time / release time | wave length | distance to laser focus | suppression of reciprocal influence |
|------------------|----------------------|----------------|------------------------------|-------------|-------------------------|-------------------------------------|
| OHDM 16N5001 | cable 4 pin | NPN | < 0,6 ms | 650 nm | 80 mm | yes |
| OHDM 16N5001/S14 | connector M12, 4 pin | NPN | < 0,6 ms | 650 nm | 80 mm | yes |
| OHDM 16P5001 | cable 4 pin | PNP | < 0,6 ms | 650 nm | 80 mm | yes |
| OHDM 16P5001/S14 | connector M12, 4 pin | PNP | < 0,6 ms | 650 nm | 80 mm | yes |
| OHDM 16P5002/S14 | connector M12, 4 pin | PNP | < 0,6 ms | 675 nm | 40 mm | yes |
| OHDM 16P5012 | cable 4 pin | PNP | < 0,1 ms | 650 nm | 60 mm | - |
| OHDM 16P5012/S14 | connector M12, 4 pin | PNP | < 0,1 ms | 650 nm | 60 mm | - |

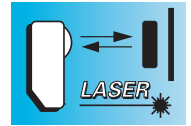

sensing distance diagram

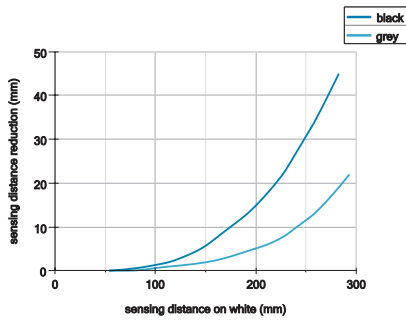

beam characteristic

distance to laser focus = 80 mm

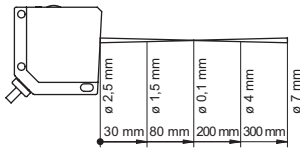

distance to laser focus = 40 mm

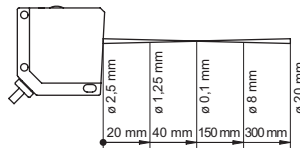

distance to laser focus = 60 mm

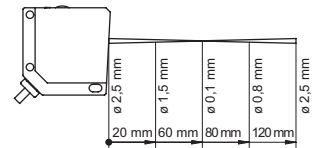

dimension drawings

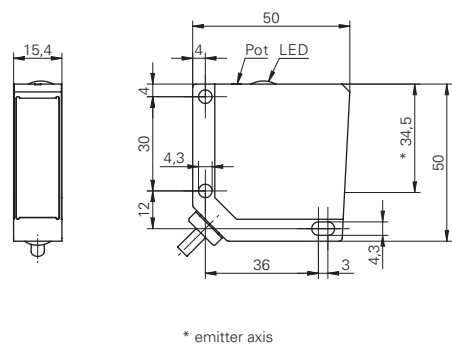
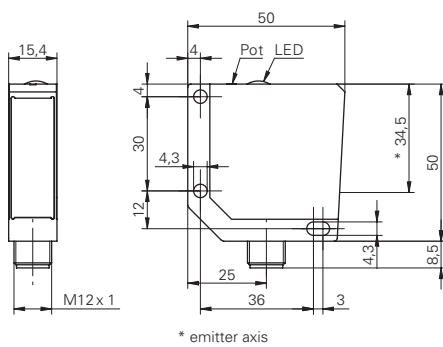

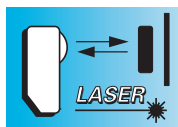

Tw = 133 mm

- for lateral detection of wafer edges
- very long range
- laser sensor in rugged metal housing



general data

| | |
|-------------------------------------|-------------------------|
| type | background suppression |
| special type | Wafer mapping sensor |
| light source | pulsed red laser diode |
| sensing distance Tw | 123 ... 143 mm |
| repeatability | < 0,1 mm at laser focus |
| output indicator | LED yellow |
| power on indication | LED green |
| sensing distance adjustment | no |
| laser class | 2 |
| wave length | 650 nm |
| suppression of reciprocal influence | yes |

electrical data

| | |
|------------------------------|----------------------|
| response time / release time | < 5 ms |
| voltage supply range +Vs | 10 ... 30 VDC |
| current consumption max. | 35 mA |
| current consumption typ. | 25 mA |
| voltage drop Vd | < 1,8 VDC |
| output function | light / dark operate |
| output current | < 200 mA |
| short circuit protection | yes |
| reverse polarity protection | yes |

mechanical data

| | |
|------------------|---------------|
| width / diameter | 15,4 mm |
| height / length | 50 mm |
| depth | 50 mm |
| type | rectangular |
| housing material | die-cast zinc |
| front (optics) | glass |
| connection types | 5 pin cable |

ambient conditions

| | |
|-----------------------|---------------|
| operating temperature | -5 ... +50 °C |
| protection class | IP 67 |

order reference output circuit

| | |
|---------------------|-----|
| OHDM 16N5651 | NPN |
| OHDM 16P5651 | PNP |

connection diagrams

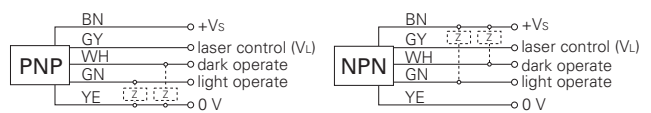

accessories

| | |
|----------------------------------|--------|
| SENSOFIX mounting kit | 151721 |
| mounting bracket | 113917 |
| lens cleaning air nozzle bracket | 116407 |

for details, see accessories section

remarks

Function laser control - input:
 - Laser diode on VL < 1 V
 - Laser diode off VL > Vs - 4 V or open

laser warning



OHDM 16 Tw = 133 mm

Diffuse sensors with background suppression

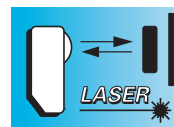

beam characteristic

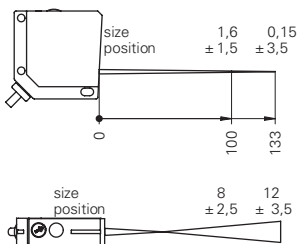

dimension drawing

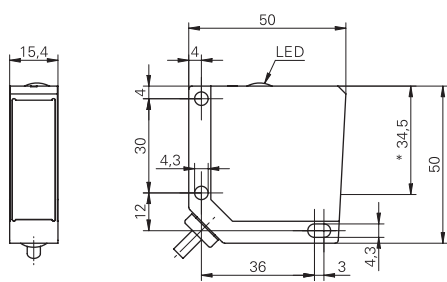

* emitter axis

OHDM 16 Tw = 133 mm
Diffuse sensors with background suppression

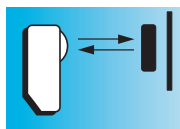

$T_w = 30 \dots 200 \text{ mm}$

- cross-technology housing concept
- sensing distance adjustable via Teach-in
- small mounting depth



general data

| | |
|-------------------------------------|--------------------------|
| type | background suppression |
| light source | pulsed red LED |
| sensing distance T_w | 30 ... 200 mm |
| sensing range T_b (at T_w max.) | 2 ... 200 mm |
| sensing range T_b (at T_w min.) | 12 ... 30 mm |
| alignment / soiled lens indicator | flashing light indicator |
| light indicator | LED green |
| output indicator | LED yellow |
| sensing distance adjustment | Teach-in |
| wave length | 660 nm |
| suppression of reciprocal influence | yes |

electrical data

| | |
|------------------------------|----------------------|
| response time / release time | < 0,5 ms |
| voltage supply range +Vs | 10 ... 30 VDC |
| current consumption max. | 48 mA |
| current consumption typ. | 28 mA |
| voltage drop V_d | < 1,8 VDC |
| output function | light / dark operate |
| output current | < 100 mA |
| short circuit protection | yes |
| reverse polarity protection | yes |

mechanical data

| | |
|------------------|---------------------|
| width / diameter | 20 mm |
| height / length | 42 mm |
| depth | 15 mm |
| type | rectangular |
| housing material | plastic (PBT-ASA) |
| front (optics) | PMMA |
| connection types | connector M8, 4 pin |

ambient conditions

| | |
|-----------------------|----------------|
| operating temperature | -25 ... +65 °C |
| protection class | IP 67 |

order reference

| | |
|-------------------|-----|
| FHDK 20N6901/S35A | NPN |
| FHDK 20P6901/S35A | PNP |

connection diagrams

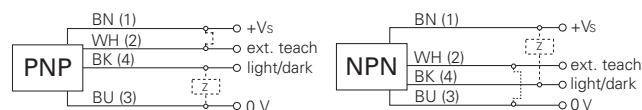

connectors

| | | |
|--------------|-------|--------------|
| ESG 32AH0200 | 4 pin | 2 m straight |
| ESW 31AH0200 | 4 pin | 2 m angular |

additional cable connectors and field wireable connectors, see accessories

accessories

| | |
|-----------------------|--------|
| SENSOFIX mounting kit | 150326 |
|-----------------------|--------|

for details, see accessories section

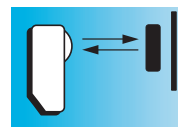

sensing distance diagram

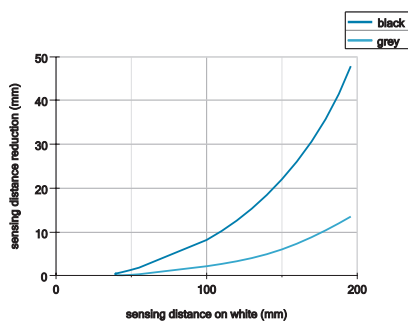

dimension drawing

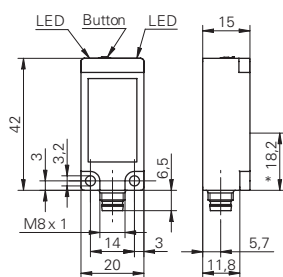

* emitter axis

FHDK 20 Tw = 30 ... 200 mm

Diffuse sensors with background suppression

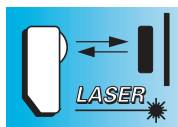

Tw = 210 ... 1500 mm



- large range
- negligible black/white difference
- two teachable sensing distances



general data

| | |
|-------------------------------|------------------------|
| type | background suppression |
| light source | pulsed red laser diode |
| sensing distance Tw | 210 ... 1500 mm |
| sensing range Tb (at Tw max.) | 200 ... 1500 mm |
| sensing range Tb (at Tw min.) | 200 ... 210 mm |
| light indicator | LED red |
| power on indication | LED green |
| sensing distance adjustment | Teach-in |
| laser class | 2 |
| beam diameter | 2 mm |
| wave length | 675 nm |

electrical data

| | |
|-----------------------------|----------------------|
| response time | < 6 ms |
| release time | < 18 ms |
| voltage supply range +Vs | 12 ... 28 VDC |
| current consumption max. | 100 mA |
| voltage drop Vd | < 5 VDC |
| output function | light / dark operate |
| output circuit | PNP |
| output current | < 20 mA |
| short circuit protection | yes |
| reverse polarity protection | yes, Vs to GND |

mechanical data

| | |
|------------------|----------------------|
| width / diameter | 20,6 mm |
| height / length | 65 mm |
| depth | 50 mm |
| type | rectangular |
| housing material | die-cast zinc |
| front (optics) | glass |
| connection types | connector M12, 5 pin |

ambient conditions

| | |
|-----------------------|--------------|
| operating temperature | 0 ... +50 °C |
| protection class | IP 67 |

order reference

OHDM 20P6990/S14C

connection diagram

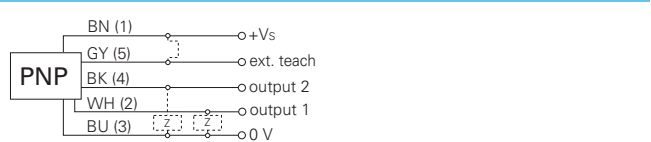

connectors

| | | |
|----------|-------|--------------|
| ES 34CP2 | 5 pin | 2 m straight |
| ES 33CP2 | 5 pin | 2 m angular |

additional cable connectors and field wireable connectors, see accessories

accessories

| | |
|------------------|--------|
| mounting bracket | 131521 |
|------------------|--------|

for details, see accessories section

laser warning



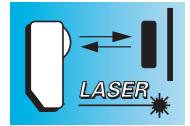

sensing distance diagram

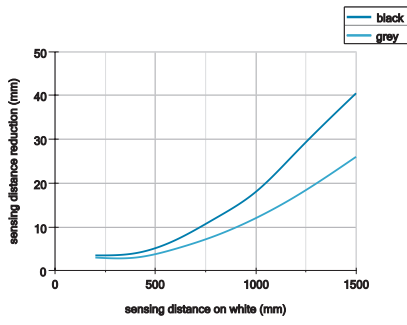

dimension drawing

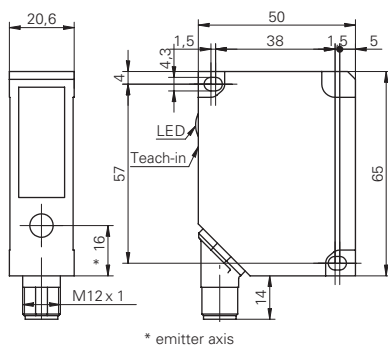

OHDM 20 Tw = 210 ... 1500 mm

Diffuse sensors with background suppression

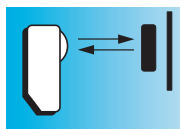

$T_w = 120 \dots 400 \text{ mm}$

- sensing distance adjustable via potentiometer
- small blind range



general data

| | |
|-------------------------------------|------------------------|
| type | background suppression |
| light source | pulsed infrared diode |
| sensing distance T_w | 120 ... 400 mm |
| sensing range T_b (at T_w max.) | 10 ... 400 mm |
| sensing range T_b (at T_w min.) | 8 ... 120 mm |
| light indicator | LED yellow |
| sensing distance adjustment | mechanical, 9 turn |
| wave length | 880 nm |

electrical data

| | |
|------------------------------|----------------------|
| response time / release time | < 1 ms |
| voltage supply range +Vs | 10 ... 30 VDC |
| current consumption max. | 45 mA |
| current consumption typ. | 35 mA |
| voltage drop Vd | < 1,8 VDC |
| output function | light / dark operate |
| output current | < 200 mA |
| short circuit protection | yes |
| reverse polarity protection | yes |

mechanical data

| | |
|------------------|---------------|
| width / diameter | 25 mm |
| height / length | 80 mm |
| depth | 58 mm |
| type | rectangular |
| housing material | plastic (ASA) |
| front (optics) | PMMA |

ambient conditions

| | |
|-----------------------|----------------|
| operating temperature | -25 ... +65 °C |
| protection class | IP 67 |

connection diagrams



connectors

| | | |
|--------------|-------|--------------|
| ESG 34AH0200 | 4 pin | 2 m straight |
| ESW 33AH0200 | 4 pin | 2 m angular |

additional cable connectors and field wireable connectors, see accessories

accessories

| | |
|------------------|--------|
| mounting bracket | 112477 |
|------------------|--------|

for details, see accessories section

| order reference | connection types | output circuit |
|------------------|----------------------|----------------|
| FHDK 26N5001/S14 | connector M12, 4 pin | NPN |
| FHDK 26P5001 | cable 4 pin | PNP |
| FHDK 26P5001/S14 | connector M12, 4 pin | PNP |

FHDK 26 $T_w = 120 \dots 400 \text{ mm}$

Diffuse sensors with background suppression

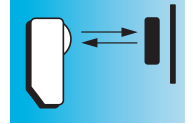



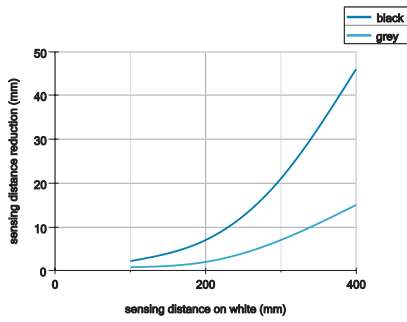

sensing distance diagram

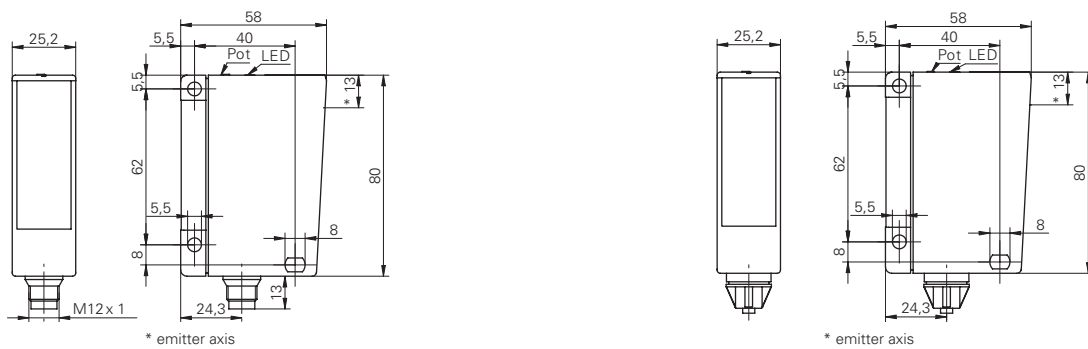

dimension drawings



red light LED version

| product family | FNCK 07 | FNDK 07 | FNDM 12 | FNDK 14 |
|------------------------------|---|---|---|---|
| |  |  |  |  |
| | <i>MINOS</i> | <i>MINOS</i> | | |
| width / diameter | 8 mm | 8 mm | 12,4 mm | 14,8 mm |
| sensing distance Tw | 10 ... 45 mm | 10 ... 45 mm | 20 ... 80 mm | 55 ... 200 mm |
| response time / release time | < 0,5 ms | < 0,5 ms | < 1 ms | < 0,5 ms |
| sensing distance adjustment | Teach-in | Teach-in | mechanical, 5 turn | Teach-in |
| NPN | ■ | ■ | ■ | ■ |
| PNP | ■ | ■ | ■ | ■ |
| cable | ■ | ■ | ■ | |
| connector | ■ | ■ | ■ | ■ |
| housing material | plastic | plastic | metal | plastic |
| | | | | |
| Page | 288 | 290 | 292 | 294 |

laser version

| product family | ONDM 16 |
|------------------------------|---|
| |  |
| width / diameter | 15,4 mm |
| sensing distance Tw | 25 ... 200 mm |
| response time / release time | < 0,6 ms |
| sensing distance adjustment | mechanical, 8 turn |
| PNP | ■ |
| cable | ■ |
| connector | ■ |
| housing material | metal |
| | |
| Page | 296 |

Diffuse sensors with foreground suppression



General information

Diffuse sensors with foreground suppression using the triangulation principle not only measure the light intensity reflected by the target, but also determine the distance of the object from the sensor. In this way, objects with the minimum size of the light beam located within the adjustable sensing distance can be detected regardless of their color and surface. Objects moving through the light beam in the adjustable foreground are suppressed.

Applications

- Detection of thin, poorly-reflecting objects on a reflective conveyor belt (if black/white offset of the diffuse sensor with background suppression becomes a problem)
- Detection of objects without a blind region. The sensor must be adjusted to a defined background, which then operates as a «reflector» (see sketch).

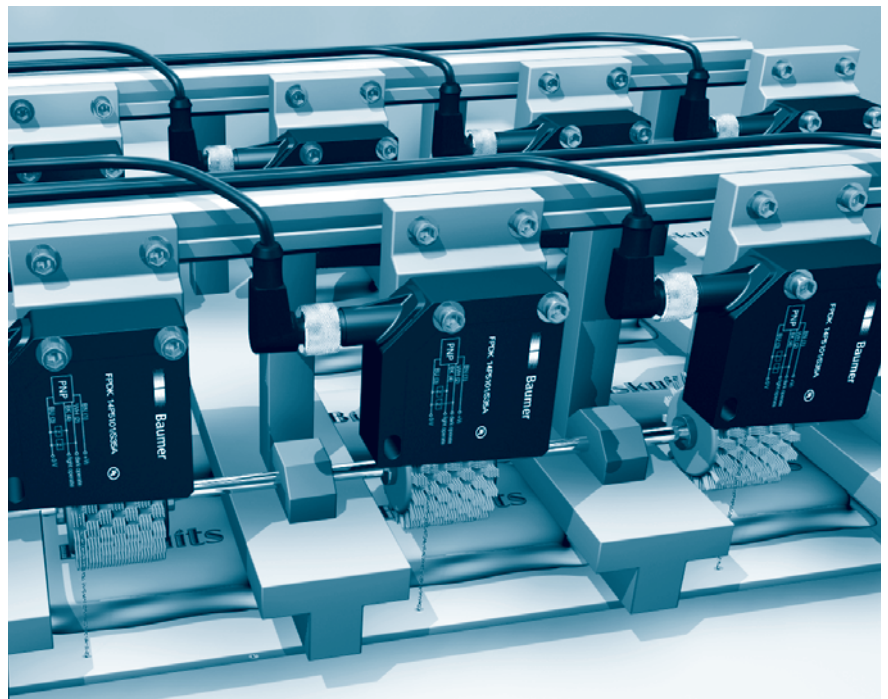
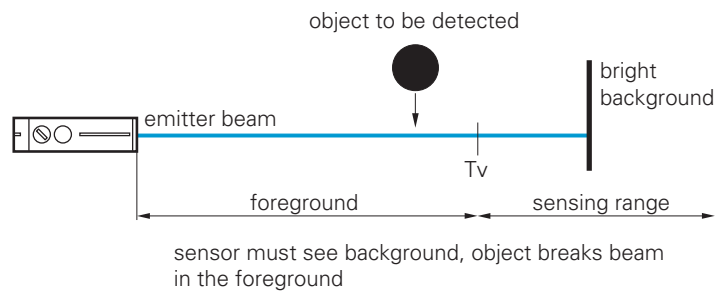



Characteristics and advantages

Adjustable foreground distance

The foreground distance or, expressed otherwise, the beginning of the sensing distance, can be precisely adjusted by a set screw or Teach-in.

Insensitive to color

The beginning of the sensing distance remains largely constant even if the color of the objects changes. Readjustment is therefore unnecessary.

Small spot size

Laser sensors can detect objects with a size of just 0,1 mm.

Short response time

Small, quickly moving objects are reliably detected due to the short response time.

Technology and operation

The sensors are based on the triangulation principle. The beginning of the sensing distance is only determined by the angle of the light reflected back from the object. The amount of reflected light is far less important.

The schematic sketch below shows that receiver R1 receives the light reflected back from the object T1 (foreground) and receiver R2 the light reflected back from object T2. The transition from R1 to R2 determines the sensing distance.

Inside the sensing distance, the sensor operates as a normal diffuse sensor, i.e. the max. range depends on the reflectivity of the object.

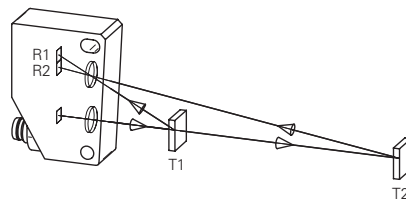

Diffuse sensors with foreground suppression



Mounting and adjustment

The diffuse sensor must be aimed at the object. The beginning of the sensing distance must be set to a distance between the target and the object in the foreground.

For diffuse sensors with foreground suppression, the sensing distance diagram is specified. This indicates the sensing distance expansion as a function of the beginning of the sensing distance to white for different degrees of remission. This means the distance by which the beginning of the sensing distance to black or gray is increased in comparison with white. When the adjusted beginning of the sensing distance to white is entered on the X axis of the diagram, the increase of the sensing distance to black or gray can be read off on the Y axis.

The sensing distance increase also indicates how far a black or gray object may be located behind the adjusted sensing distance for the object to be correctly detected.

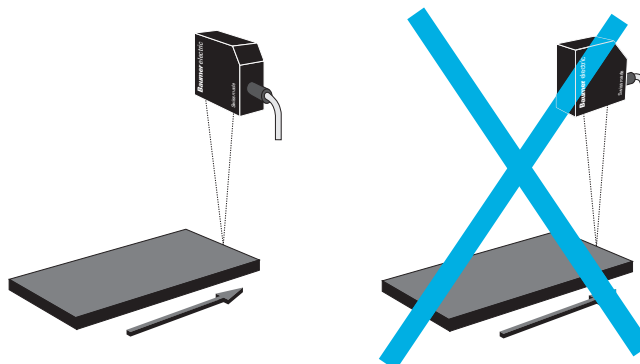
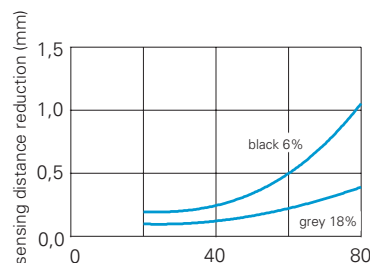

It should be ensured that the object to be detected approaches the active area of the sensor from the side, which avoids malfunctions.

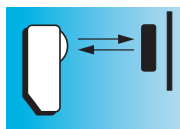

Tw = 10 ... 45 mm



- ultra compact housing
- sensing distance adjustable via Teach-in
- suppression of mutual opt. Interferene

general data

| | |
|-------------------------------------|--------------------------|
| type | foreground suppression |
| light source | pulsed red LED |
| sensing distance Tw | 10 ... 45 mm |
| sensing range Tb (at Tw max.) | 45 ... 150 mm |
| sensing range Tb (at Tw min.) | 10 ... 150 mm |
| alignment / soiled lens indicator | flashing light indicator |
| light indicator | LED green |
| output indicator | LED yellow |
| sensing distance adjustment | Teach-in |
| wave length | 660 nm |
| suppression of reciprocal influence | yes |

electrical data

| | |
|------------------------------|----------------------|
| response time / release time | < 0,5 ms |
| voltage supply range +Vs | 10 ... 30 VDC |
| current consumption max. | 25 mA |
| current consumption typ. | 20 mA |
| voltage drop Vd | < 1,8 VDC |
| output function | light / dark operate |
| output current | < 100 mA |
| short circuit protection | yes |
| reverse polarity protection | yes |

mechanical data

| | |
|------------------|--------------------------|
| width / diameter | 8 mm |
| height / length | 16,2 mm |
| depth | 10,8 mm |
| type | rectangular |
| housing material | plastic (PMMA, MABS, PA) |
| front (optics) | PMMA |

ambient conditions

| | |
|-----------------------|----------------|
| operating temperature | -20 ... +50 °C |
| protection class | IP 65 |

connection diagrams



connectors

| | | |
|--------------|-------|--------------|
| ESG 32AH0200 | 4 pin | 2 m straight |
| ESW 31AH0200 | 4 pin | 2 m angular |

additional cable connectors and field wireable connectors, see accessories

accessories

| | |
|----------------------|--------|
| MINOFIX mounting kit | 150844 |
|----------------------|--------|

for details, see accessories section

| order reference | connection types | output circuit |
|--------------------|-----------------------------|----------------|
| FNCK 07N6901 | cable rear side | NPN |
| FNCK 07N6901/KS35A | flylead connector M8, 4 pin | NPN |
| FNCK 07P6901 | cable rear side | PNP |
| FNCK 07P6901/KS35A | flylead connector M8, 4 pin | PNP |

Diffuse sensors with foreground suppression MINOS FNCK 07 Tw = 10 ... 45 mm

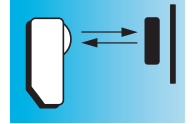

sensing distance diagram

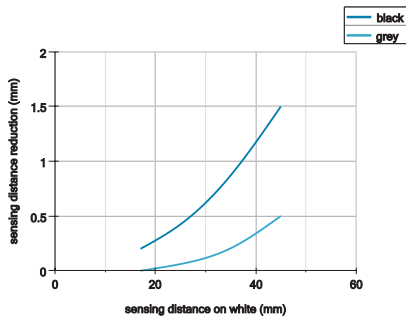

dimension drawings

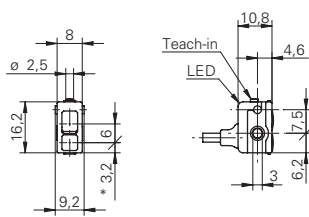

* emitter axis

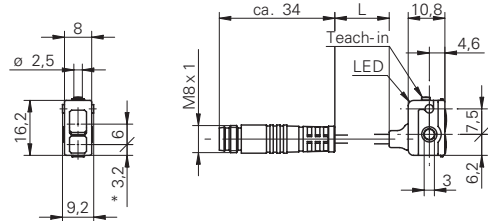

* emitter axis cable length L = 200 mm

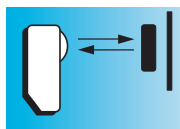

Tw = 10 ... 45 mm



- ultra compact housing
- sensing distance adjustable via Teach-in
- suppression of mutual optical interference

general data

| | |
|-------------------------------------|--------------------------|
| type | foreground suppression |
| light source | pulsed red LED |
| sensing distance Tw | 10 ... 45 mm |
| sensing range Tb (at Tw max.) | 45 ... 150 mm |
| sensing range Tb (at Tw min.) | 10 ... 150 mm |
| alignment / soiled lens indicator | flashing light indicator |
| light indicator | LED green |
| output indicator | LED yellow |
| sensing distance adjustment | Teach-in |
| wave length | 660 nm |
| suppression of reciprocal influence | yes |

electrical data

| | |
|------------------------------|----------------------|
| response time / release time | < 0,5 ms |
| voltage supply range +Vs | 10 ... 30 VDC |
| current consumption max. | 25 mA |
| current consumption typ. | 20 mA |
| voltage drop Vd | < 1,8 VDC |
| output function | light / dark operate |
| output current | < 100 mA |
| short circuit protection | yes |
| reverse polarity protection | yes |

mechanical data

| | |
|------------------|--------------------------|
| width / diameter | 8 mm |
| height / length | 16,2 mm |
| depth | 10,8 mm |
| type | rectangular |
| housing material | plastic (PMMA, MABS, PA) |
| front (optics) | PMMA |

ambient conditions

| | |
|-----------------------|----------------|
| operating temperature | -20 ... +50 °C |
| protection class | IP 65 |

connection diagrams



connectors

| | | |
|--------------|-------|--------------|
| ESG 32AH0200 | 4 pin | 2 m straight |
| ESW 31AH0200 | 4 pin | 2 m angular |

additional cable connectors and field wireable connectors, see accessories

accessories

| | |
|----------------------|--------|
| MINOFIX mounting kit | 150844 |
|----------------------|--------|

for details, see accessories section

| order reference | connection types | output circuit |
|--------------------|-----------------------------|----------------|
| FNDK 07N6901 | cable bottom side | NPN |
| FNDK 07N6901/KS35A | flylead connector M8, 4 pin | NPN |
| FNDK 07P6901 | cable bottom side | PNP |
| FNDK 07P6901/KS35A | flylead connector M8, 4 pin | PNP |

FNDK 07 Tw = 10 ... 45 mm

MINOS

Diffuse sensors with foreground suppression

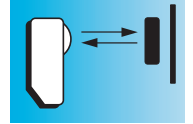

sensing distance diagram

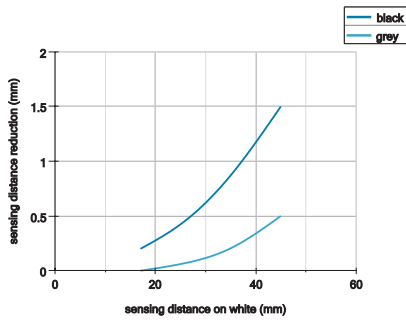

dimension drawings



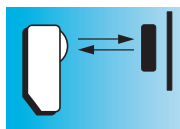

Tw = 20 ... 80 mm

- rugged miniature metal housing
- sensing distance adjustable via potentiometer



general data

| | |
|-------------------------------|------------------------|
| type | foreground suppression |
| light source | pulsed red LED |
| sensing distance Tw | 20 ... 80 mm |
| sensing range Tb (at Tw max.) | 80 ... 160 mm |
| sensing range Tb (at Tw min.) | 20 ... 30 mm |
| light indicator | LED yellow |
| sensing distance adjustment | mechanical, 5 turn |
| wave length | 660 nm |

electrical data

| | |
|------------------------------|----------------------|
| response time / release time | < 1 ms |
| voltage supply range +Vs | 10 ... 30 VDC |
| current consumption max. | 35 mA |
| current consumption typ. | 25 mA |
| voltage drop Vd | < 1,8 VDC |
| output function | light / dark operate |
| output current | < 100 mA |
| short circuit protection | yes |
| reverse polarity protection | yes |

mechanical data

| | |
|------------------|---------------|
| width / diameter | 12,4 mm |
| height / length | 35 mm |
| depth | 35 mm |
| type | rectangular |
| housing material | die-cast zinc |
| front (optics) | PMMA |

ambient conditions

| | |
|-----------------------|----------------|
| operating temperature | -25 ... +65 °C |
| protection class | IP 67 |

connection diagrams



connectors

| | | |
|--------------|-------|--------------|
| ESG 32AH0200 | 4 pin | 2 m straight |
| ESW 31AH0200 | 4 pin | 2 m angular |

additional cable connectors and field wireable connectors, see accessories

accessories

| | |
|-----------------------|--------|
| SENSOFIX mounting kit | 150328 |
| mounting bracket | 113873 |

for details, see accessories section

| order reference | connection types | output circuit |
|-------------------|---------------------|----------------|
| FNDM 12N5001 | cable 4 pin | NPN |
| FNDM 12N5001/S35A | connector M8, 4 pin | NPN |
| FNDM 12P5001 | cable 4 pin | PNP |
| FNDM 12P5001/S35A | connector M8, 4 pin | PNP |

FNDM 12 Tw = 20 ... 80 mm

Diffuse sensors with foreground suppression

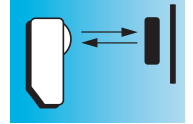

sensing distance diagram

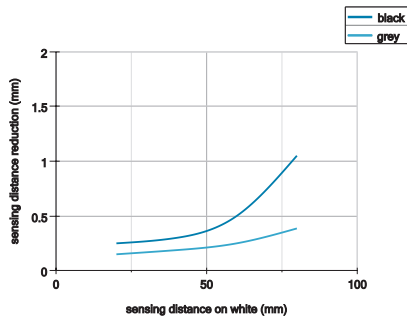

dimension drawings

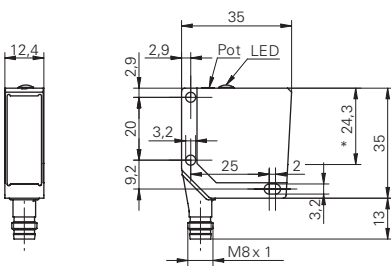

* emitter axis

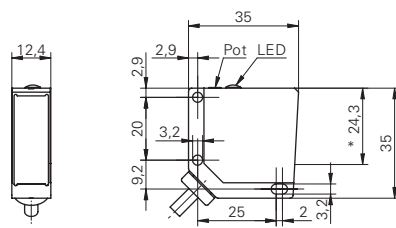

* emitter axis

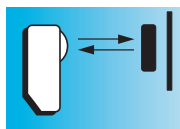

Tw = 55 ... 200 mm

- short response time
- sensing distance adjustable via Teach-in



general data

| | |
|-------------------------------------|--------------------------|
| type | foreground suppression |
| light source | pulsed red LED |
| sensing distance Tw | 55 ... 200 mm |
| sensing range Tb (at Tw max.) | 200 ... 350 mm |
| sensing range Tb (at Tw min.) | 55 ... 350 mm |
| alignment / soiled lens indicator | flashing light indicator |
| light indicator | LED yellow |
| output indicator | LED yellow |
| sensing distance adjustment | Teach-in |
| wave length | 660 nm |
| suppression of reciprocal influence | yes |

electrical data

| | |
|------------------------------|----------------------|
| response time / release time | < 0,5 ms |
| voltage supply range +Vs | 10 ... 30 VDC |
| current consumption max. | 40 mA |
| current consumption typ. | 35 mA |
| voltage drop Vd | < 1,8 VDC |
| output function | light / dark operate |
| output current | < 100 mA |
| short circuit protection | yes |
| reverse polarity protection | yes |

mechanical data

| | |
|------------------|---------------------|
| width / diameter | 14,8 mm |
| height / length | 43 mm |
| depth | 31 mm |
| type | rectangular |
| housing material | plastic (PA12) |
| front (optics) | PA |
| connection types | connector M8, 4 pin |

ambient conditions

| | |
|-----------------------|----------------|
| operating temperature | -25 ... +65 °C |
| protection class | IP 67 |

| order reference | output circuit |
|-------------------|----------------|
| FNDK 14N6901/S35A | NPN |
| FNDK 14P6901/S35A | PNP |

connection diagrams



connectors

| | | |
|--------------|-------|--------------|
| ESG 32AH0200 | 4 pin | 2 m straight |
| ESW 31AH0200 | 4 pin | 2 m angular |

additional cable connectors and field wireable connectors, see accessories

accessories

| | |
|-----------------------|--------|
| SENSOFIX mounting kit | 149011 |
| mounting bracket | 134964 |

for details, see accessories section

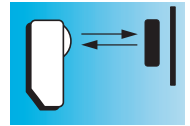

sensing distance diagram

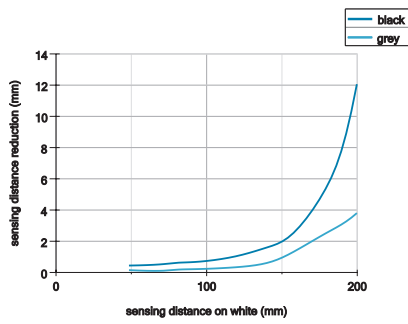

dimension drawing

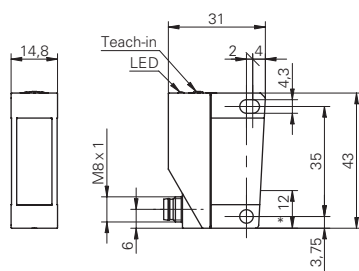

* emitter axis

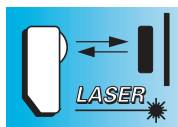

Tw = 25 ... 200 mm

- rugged metal housing
- high repeatability



general data

| | |
|-------------------------------------|-------------------------|
| type | foreground suppression |
| light source | pulsed red laser diode |
| sensing distance Tw | 25 ... 200 mm |
| sensing range Tb (at Tw max.) | 200 ... 500 mm |
| sensing range Tb (at Tw min.) | 25 ... 45 mm |
| repeatability | < 0,1 mm at laser focus |
| light indicator | LED yellow |
| sensing distance adjustment | mechanical, 8 turn |
| laser class | 2 |
| distance to laser focus | 80 mm |
| wave length | 650 nm |
| suppression of reciprocal influence | yes |

electrical data

| | |
|------------------------------|----------------------|
| response time / release time | < 0,6 ms |
| voltage supply range +Vs | 10 ... 30 VDC |
| current consumption max. | 35 mA |
| current consumption typ. | 25 mA |
| voltage drop Vd | < 1,8 VDC |
| output function | light / dark operate |
| output circuit | PNP |
| output current | < 200 mA |
| short circuit protection | yes |
| reverse polarity protection | yes |

mechanical data

| | |
|------------------|---------------|
| width / diameter | 15,4 mm |
| height / length | 50 mm |
| depth | 50 mm |
| type | rectangular |
| housing material | die-cast zinc |
| front (optics) | glass |

ambient conditions

| | |
|-----------------------|----------------|
| operating temperature | -10 ... +50 °C |
| protection class | IP 67 |

order reference

| | |
|-------------------------|----------------------|
| ONDM 16P5101 | cable 4 pin |
| ONDM 16P5101/S14 | connector M12, 4 pin |

connection diagram

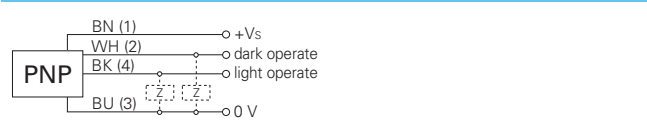

connectors

| | | |
|--------------|-------|--------------|
| ESG 34AH0200 | 4 pin | 2 m straight |
| ESW 33AH0200 | 4 pin | 2 m angular |

additional cable connectors and field wireable connectors, see accessories

accessories

| | |
|----------------------------------|--------|
| SENSOFIX mounting kit | 151721 |
| mounting bracket | 113917 |
| lens cleaning air nozzle bracket | 116407 |

for details, see accessories section

laser warning

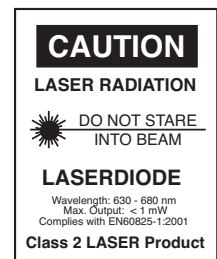

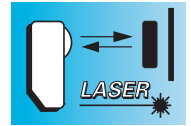

sensing distance diagram

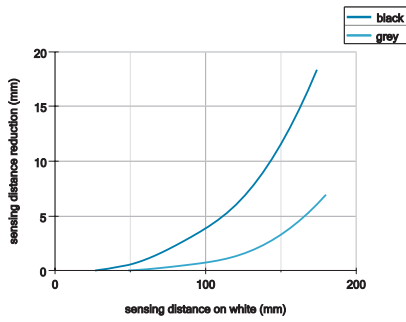



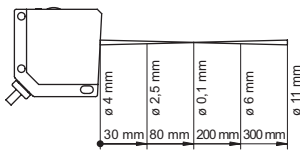

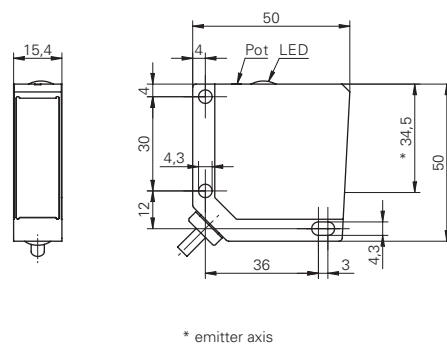
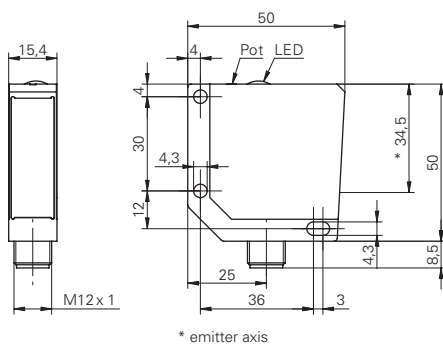

beam characteristic







dimension drawings





red light LED version

| product family | FZCK 07 | FZDK 07 | FZDM 08 | FZAM 08 | FZDK 10 | FZDM 12 | FZAM 12 |
|------------------------------|---|---|---|---|---|---|---|
| |  |  |  |  |  |  |  |
| | <i>MINOS</i> | <i>MINOS</i> | | | | | |
| width / diameter | 8 mm | 8 mm | 8 mm | 8 mm | 10,4 mm | 12,4 mm | 12 mm |
| sensing distance Tw | 20 ... 150 mm | 20 ... 150 mm | < 40 mm < 80 mm | < 40 mm < 80 mm | 5 ... 200 mm | 30 ... 250 mm | 30 ... 200 mm |
| response time / release time | < 0,5 ms | < 0,5 ms | < 1 ms | < 1 ms | < 1 ms | < 1 ms | < 1 ms |
| sensitivity adjustment | Teach-in | Teach-in | no | no | Pot, 270° | Pot, 5 turn | Pot, 270° |
| NPN | ■ | ■ | | | ■ | ■ | ■ |
| PNP | ■ | ■ | ■ | ■ | ■ | ■ | ■ |
| cable | ■ | ■ | ■ | ■ | ■ | ■ | ■ |
| connector | ■ | ■ | ■ | ■ | ■ | ■ | ■ |
| housing material | plastic | plastic | metal | metal | plastic | metal | metal |
| | | | | | | | |
| Page | 302 | 304 | 306 | 308 | 310 | 316 | 318 |

laser version

| product family | OZDK 10 | OZDK 10 | OZDK 14 | OZDM 16 | OZDM 16 |
|------------------------------|---|---|---|---|---|
| |  |  |  |  |  |
| version | | line beam | | | |
| width / diameter | 10,4 mm | 10,4 mm | 14,8 mm | 15,4 mm | 15,4 mm |
| sensing distance Tw | 3 ... 150 mm | 3 ... 150 mm | 20 ... 300 mm | 0 ... 250 mm | 0 ... 250 mm |
| response time / release time | < 0,05 ms | < 0,05 ms | < 0,15 ms | < 0,05 ms | < 0,1 ms |
| sensitivity adjustment | Pot, 5 turn | Pot, 5 turn | Teach-in | Pot, 14 turn | Pot, 14 turn |
| NPN | ■ | ■ | ■ | ■ | |
| PNP | ■ | ■ | ■ | ■ | ■ |
| cable | ■ | ■ | | ■ | ■ |
| connector | ■ | ■ | ■ | ■ | ■ |
| housing material | plastic | plastic | plastic | metal | metal |
| | | | | | |
| Page | 312 | 314 | 322 | 326 | 328 |

| FZDK 14 | FZDM 16 | FZAM 18 | FZAM 18 | FZAM 18 | FZDK 20 | FZAM 30 |
|---|---|---|---|---|---|---|
|  |  |  |  |  |  |  |
| 14,8 mm | 15,4 mm | 18 mm | 18 mm | 18 mm | 20 mm | 30 mm |
| 5 ... 600 mm | 0 ... 400 mm | 60 ... 430 mm | 20 ... 150 mm | 60 ... 430 mm | 5 ... 500 mm | 100 ... 700 mm 300 ... 1500 mm |
| < 1 ms | < 1 ms | < 1 ms | < 0,5 ms | < 1 ms | < 0,5 ms | < 0,25 ms < 2,5 ms |
| Pot, 270° | Pot, 270° | Teach-in | Pot, 15 turn | Pot, 270° | Pot, 270° | Pot, 15 turn |
| ■ | ■ | ■ | ■ | ■ | ■ | ■ |
| ■ | ■ | ■ | ■ | ■ | ■ | ■ |
| | ■ | ■ | ■ | ■ | ■ | ■ |
| ■ | ■ | ■ | | ■ | ■ | |
| plastic | metal | metal | metal | metal | plastic | metal |
| | | | | | | |
| 320 | 324 | 330 | 332 | 334 | 336 | 338 |

Diffuse sensor with intensity difference



General information

The emitter and receiver are in the same housing. The emitted infrared, red or laser light is reflected directly by the target back to the sensor. If the target reflects sufficiently well, the received light causes the sensor to switch.

Applications

- Differentiation and sorting of objects, e.g. by size, degree of reflection etc.
- Counting of objects
- Presence check, e.g. of a paper stack.

Characteristics and advantages

- Exploitation of the reflection from the target
 - Suitable to discern black from white
 - Relatively large active range
 - Simple installation (only one sensor)
 - Short response time
- The sensing distance depends largely on the reflective properties of the object surface.
 - Suitable to discern between black and white objects.
 - Relatively large active range.
 - Positioning and monitoring with just one sensor.

Technology and operation

The light shining on the target is largely diffused and reflected back in all directions. A very small part of this remitted light is observed by the receiver. If the target reflects sufficiently well, the received light causes the sensor to switch.

As the sensor operates with the reflection from the materials, the surface properties, color and gloss have a great influence on the switching distance.

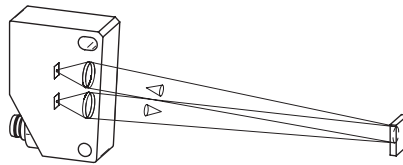

Diffuse sensor with intensity difference



Mounting and adjustment

With diffuse sensors operating by the intensity difference principle, the relative receiving signal is specified. This represents the signal level received from a white object as a function of the distance. Using this diagram, the sensing range can be determined for an object which is not white. The correction factor of the respective material is required for this purpose.

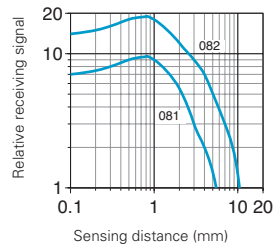

Correction factor

The material and surface properties of the object (representing the reflectivity) influence the switching distance of a diffuse sensor with intensity difference. To determine the corrected switching distance, the following values must therefore be applied to the relative receiving signal (KFs) or in approximation to the distance (KFd).

| Material | KFs | KFd |
|------------------------|------|------|
| Kodak test card | 100% | 100% |
| Pale, planed wood | 80% | 90% |
| Rough wood | 20% | 45% |
| Drawn aluminum | 25% | 50% |
| Cardboard, matte black | 7% | 26% |

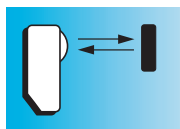

Tw = 20 ... 150 mm



- ultra compact housing
- sensitivity adjustable via Teach-in
- suppression of mutual opt. interference

general data

| | |
|-------------------------------------|--------------------------|
| type | intensity difference |
| light source | pulsed red LED |
| sensing distance Tw | 20 ... 150 mm |
| alignment / soiled lens indicator | flashing light indicator |
| light indicator | LED green |
| output indicator | LED yellow |
| sensitivity adjustment | Teach-in |
| wave length | 660 nm |
| suppression of reciprocal influence | yes |

electrical data

| | |
|------------------------------|----------------------|
| response time / release time | < 0,5 ms |
| voltage supply range +Vs | 10 ... 30 VDC |
| current consumption max. | 25 mA |
| current consumption typ. | 20 mA |
| voltage drop Vd | < 1,8 VDC |
| output function | light / dark operate |
| output current | < 100 mA |
| short circuit protection | yes |
| reverse polarity protection | yes |

mechanical data

| | |
|------------------|--------------------------|
| width / diameter | 8 mm |
| height / length | 16,2 mm |
| depth | 10,8 mm |
| type | rectangular |
| housing material | plastic (PMMA, MABS, PA) |
| front (optics) | PMMA |

ambient conditions

| | |
|-----------------------|----------------|
| operating temperature | -20 ... +50 °C |
| protection class | IP 65 |

connection diagrams



connectors

| | | |
|--------------|-------|--------------|
| ESG 32AH0200 | 4 pin | 2 m straight |
| ESW 31AH0200 | 4 pin | 2 m angular |

additional cable connectors and field wireable connectors, see accessories

accessories

| | |
|----------------------|--------|
| MINOFIX mounting kit | 150844 |
|----------------------|--------|

for details, see accessories section

| order reference | connection types | output circuit |
|--------------------|-----------------------------|----------------|
| FZCK 07N6901 | cable rear side | NPN |
| FZCK 07N6901/KS35A | flylead connector M8, 4 pin | NPN |
| FZCK 07P6901 | cable rear side | PNP |
| FZCK 07P6901/KS35A | flylead connector M8, 4 pin | PNP |

FZCK 07 Tw = 20 ... 150 mm MINOS Diffuse sensors with intensity difference

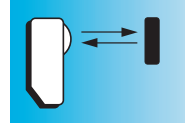

relative receiving signal

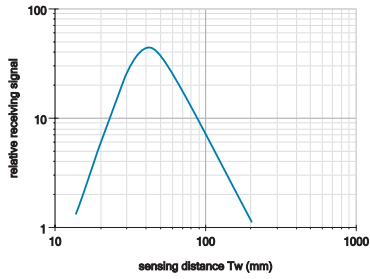

dimension drawings

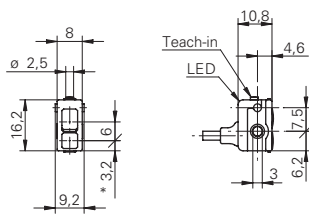

* emitter axis

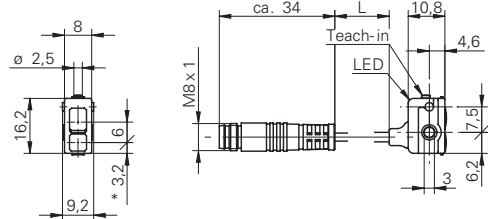

* emitter axis cable length L = 200 mm

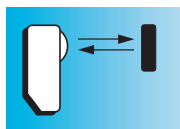

Tw = 20 ... 150 mm



- ultra compact housing
- sensitivity adjustable via Teach-in
- suppression of mutual optical interference

general data

| | |
|-------------------------------------|--------------------------|
| type | intensity difference |
| light source | pulsed red LED |
| sensing distance Tw | 20 ... 150 mm |
| alignment / soiled lens indicator | flashing light indicator |
| light indicator | LED green |
| output indicator | LED yellow |
| sensitivity adjustment | Teach-in |
| wave length | 660 nm |
| suppression of reciprocal influence | yes |

electrical data

| | |
|------------------------------|----------------------|
| response time / release time | < 0,5 ms |
| voltage supply range +Vs | 10 ... 30 VDC |
| current consumption max. | 25 mA |
| current consumption typ. | 20 mA |
| voltage drop Vd | < 1,8 VDC |
| output function | light / dark operate |
| output current | < 100 mA |
| short circuit protection | yes |
| reverse polarity protection | yes |

mechanical data

| | |
|------------------|--------------------------|
| width / diameter | 8 mm |
| height / length | 16,2 mm |
| depth | 10,8 mm |
| type | rectangular |
| housing material | plastic (PMMA, MABS, PA) |
| front (optics) | PMMA |

ambient conditions

| | |
|-----------------------|----------------|
| operating temperature | -20 ... +50 °C |
| protection class | IP 65 |

connection diagrams



connectors

| | | |
|--------------|-------|--------------|
| ESG 32AH0200 | 4 pin | 2 m straight |
| ESW 31AH0200 | 4 pin | 2 m angular |

additional cable connectors and field wireable connectors, see accessories

accessories

| | |
|----------------------|--------|
| MINOFIX mounting kit | 150844 |
|----------------------|--------|

for details, see accessories section

| order reference | connection types | output circuit |
|--------------------|-----------------------------|----------------|
| FZDK 07N6901 | cable bottom side | NPN |
| FZDK 07N6901/KS35A | flylead connector M8, 4 pin | NPN |
| FZDK 07P6901 | cable bottom side | PNP |
| FZDK 07P6901/KS35A | flylead connector M8, 4 pin | PNP |

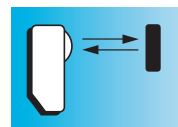

relative receiving signal

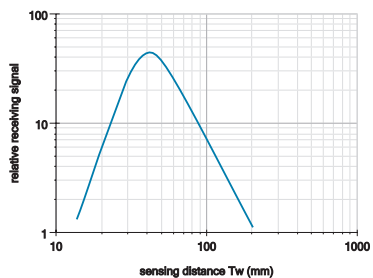

dimension drawings



* emitter axis

* emitter axis cable length L = 200 mm

Diffuse sensors with intensity difference MINOS FZDK 07 Tw = 20 ... 150 mm

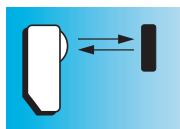

Tw = 40 mm
Tw = 80 mm

- subminiature metal housing
- fixed sensing distance



general data

| | |
|-------------------------------------|--------------------------|
| type | intensity difference |
| light source | pulsed infrared diode |
| alignment / soiled lens indicator | flashing light indicator |
| light indicator | LED red |
| sensitivity adjustment | no |
| wave length | 880 nm |
| suppression of reciprocal influence | yes |

electrical data

| | |
|------------------------------|---------------|
| response time / release time | < 1 ms |
| voltage supply range +Vs | 10 ... 30 VDC |
| current consumption max. | 42 mA |
| current consumption typ. | 20 mA |
| voltage drop Vd | < 2 VDC |
| output circuit | PNP |
| output current | < 100 mA |
| short circuit protection | yes |
| reverse polarity protection | yes |

mechanical data

| | |
|------------------|-------------------|
| width / diameter | 8 mm |
| height / length | 58 mm |
| depth | 12 mm |
| type | rectangular |
| housing material | aluminum anodized |
| front (optics) | PC |

ambient conditions

| | |
|-----------------------|----------------|
| operating temperature | -25 ... +65 °C |
| protection class | IP 65 |

connection diagram

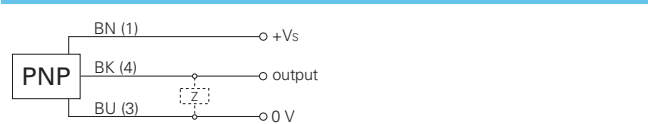

connectors

| | | |
|--------------|-------|--------------|
| ESG 32SH0200 | 3 pin | 2 m straight |
| ESW 31SH0200 | 3 pin | 2 m angular |

additional cable connectors and field wireable connectors, see accessories

| order reference | sensing distance Tw | connection types | output function |
|-------------------|---------------------|---------------------|-----------------|
| FZDM 08P1001 | < 40 mm | cable 3 pin | light operate |
| FZDM 08P1001/S35L | < 40 mm | connector M8, 3 pin | light operate |
| FZDM 08P1002 | < 80 mm | cable 3 pin | light operate |
| FZDM 08P1002/S35L | < 80 mm | connector M8, 3 pin | light operate |
| FZDM 08P3001 | < 40 mm | cable 3 pin | dark operate |
| FZDM 08P3001/S35L | < 40 mm | connector M8, 3 pin | dark operate |
| FZDM 08P3002 | < 80 mm | cable 3 pin | dark operate |
| FZDM 08P3002/S35L | < 80 mm | connector M8, 3 pin | dark operate |

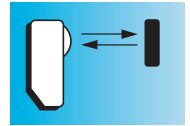

relative receiving signal

Tw < 40 mm

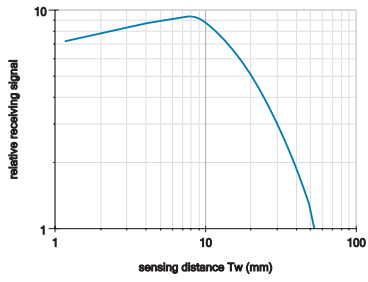

Tw < 80 mm

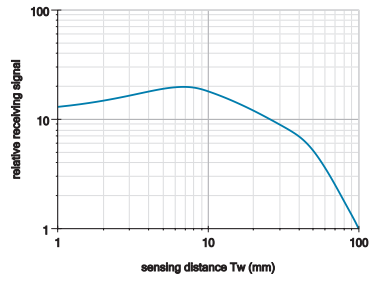

dimension drawings

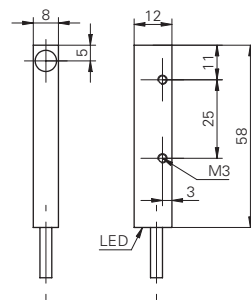
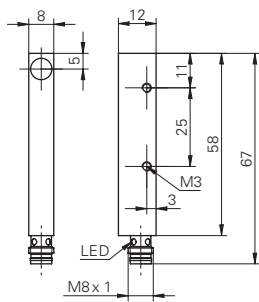

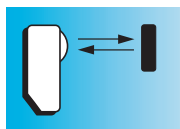

Tw = 40 mm
Tw = 80 mm

- subminiature metal housing
- fixed sensing distance

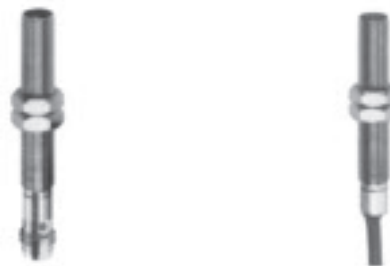

general data

| | |
|-------------------------------------|--------------------------|
| type | intensity difference |
| light source | pulsed infrared diode |
| alignment / soiled lens indicator | flashing light indicator |
| light indicator | LED red |
| sensitivity adjustment | no |
| wave length | 880 nm |
| suppression of reciprocal influence | yes |

electrical data

| | |
|------------------------------|---------------|
| response time / release time | < 1 ms |
| voltage supply range +Vs | 10 ... 30 VDC |
| current consumption max. | 42 mA |
| current consumption typ. | 20 mA |
| voltage drop Vd | < 2 VDC |
| output circuit | PNP |
| output current | < 100 mA |
| short circuit protection | yes |
| reverse polarity protection | yes |

mechanical data

| | |
|------------------|---------------------|
| width / diameter | 8 mm |
| type | cylindrical |
| housing material | brass nickel plated |
| front (optics) | PC |

ambient conditions

| | |
|-----------------------|----------------|
| operating temperature | -25 ... +65 °C |
| protection class | IP 65 |

connection diagram

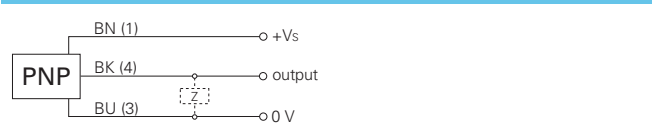

connectors

| | | |
|--------------|-------|--------------|
| ESG 32SH0200 | 3 pin | 2 m straight |
| ESW 31SH0200 | 3 pin | 2 m angular |

additional cable connectors and field wireable connectors, see accessories

accessories

| | |
|-----------------------|--------|
| SENSOFIX mounting kit | 151719 |
|-----------------------|--------|

for details, see accessories section

| order reference | sensing distance Tw | height / length | connection types | output function |
|-------------------|---------------------|-----------------|---------------------|-----------------|
| FZAM 08P1001 | < 40 mm | 56 mm | cable 3 pin | light operate |
| FZAM 08P1001/S35L | < 40 mm | 73 mm | connector M8, 3 pin | light operate |
| FZAM 08P1002 | < 80 mm | 56 mm | cable 3 pin | light operate |
| FZAM 08P1002/S35L | < 80 mm | 73 mm | connector M8, 3 pin | light operate |
| FZAM 08P3001 | < 40 mm | 56 mm | cable 3 pin | dark operate |
| FZAM 08P3001/S35L | < 40 mm | 73 mm | connector M8, 3 pin | dark operate |
| FZAM 08P3002 | < 80 mm | 56 mm | cable 3 pin | dark operate |
| FZAM 08P3002/S35L | < 80 mm | 73 mm | connector M8, 3 pin | dark operate |

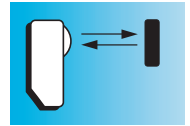

relative receiving signal

Tw < 40 mm

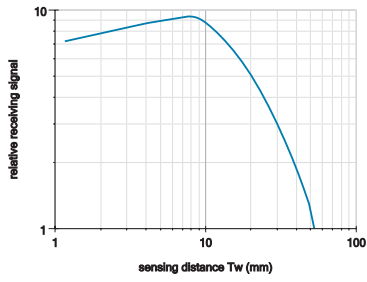

Tw < 80 mm

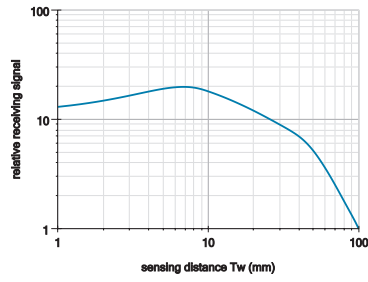

dimension drawings

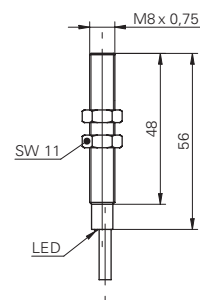
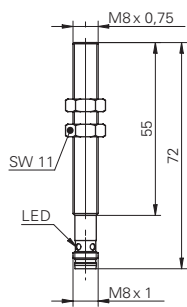

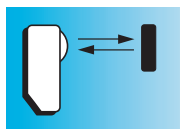

Tw = 5 ... 200 mm

- subminiature housing
- sensing distance adjustable via potentiometer



general data

| | |
|-------------------------------------|--------------------------|
| type | intensity difference |
| light source | pulsed red LED |
| sensing distance Tw | 5 ... 200 mm |
| alignment / soiled lens indicator | flashing light indicator |
| light indicator | LED yellow |
| sensitivity adjustment | Pot, 270° |
| wave length | 660 nm |
| suppression of reciprocal influence | yes |

electrical data

| | |
|------------------------------|---------------|
| response time / release time | < 1 ms |
| voltage supply range +Vs | 10 ... 30 VDC |
| current consumption max. | 30 mA |
| current consumption typ. | 20 mA |
| voltage drop Vd | < 1,8 VDC |
| output current | < 100 mA |
| short circuit protection | yes |
| reverse polarity protection | yes |

mechanical data

| | |
|------------------|---------------|
| width / diameter | 10,4 mm |
| height / length | 27 mm |
| depth | 14 mm |
| type | rectangular |
| housing material | plastic (ASA) |
| front (optics) | PMMA |

ambient conditions

| | |
|-----------------------|----------------|
| operating temperature | -25 ... +65 °C |
|-----------------------|----------------|

connection diagrams

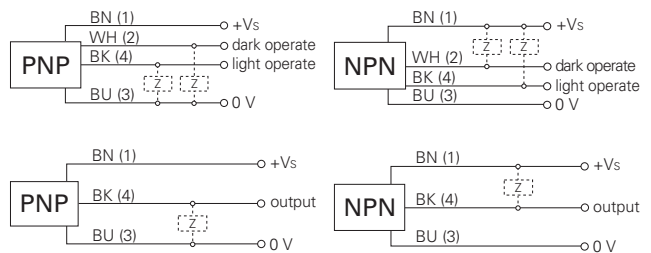

connectors

| | | |
|--------------|-------|--------------|
| ESG 32SH0200 | 3 pin | 2 m straight |
| ESW 31SH0200 | 3 pin | 2 m angular |
| ESG 32AH0200 | 4 pin | 2 m straight |
| ESW 31AH0200 | 4 pin | 2 m angular |

additional cable connectors and field wireable connectors, see accessories

accessories

| | |
|-----------------------------------|--------|
| SENSOFIX mounting kit | 150326 |
| mounting bracket (cable type) | 114501 |
| mounting bracket (connector type) | 133792 |

for details, see accessories section

| order reference | connection types | output circuit | output function | protection class |
|-------------------|-----------------------------|----------------|----------------------|------------------|
| FZDK 10N1101/KS35 | flylead connector M8, 3 pin | NPN | light operate | IP 65 |
| FZDK 10N5101 | cable 4 pin | NPN | light / dark operate | IP 65 |
| FZDK 10N5101/S35A | connector M8, 4 pin | NPN | light / dark operate | IP 67 |
| FZDK 10P1101/KS35 | flylead connector M8, 3 pin | PNP | light operate | IP 65 |
| FZDK 10P5101 | cable 4 pin | PNP | light / dark operate | IP 65 |
| FZDK 10P5101/S35A | connector M8, 4 pin | PNP | light / dark operate | IP 67 |

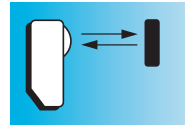

relative receiving signal

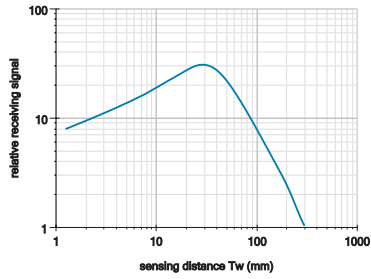

dimension drawings

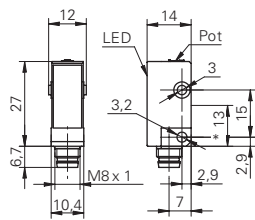

* emitter axis

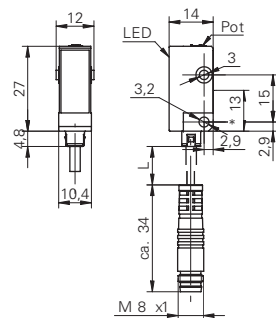

* emitter axis cable length L = 200 mm

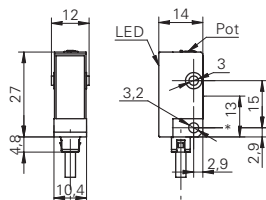

* emitter axis

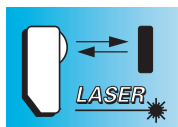

Tw = 3 ... 150 mm

- subminiature housing
- line beam
- very short response time



general data

| | |
|---|-------------------------|
| type | intensity difference |
| light source | pulsed red laser diode |
| sensing distance Tw | 3 ... 150 mm |
| optimum operating distance | 20 ... 40 mm |
| detectable remission difference (on grey) | > 8 % |
| repeatability | < 0,2 mm at laser focus |
| light indicator | LED yellow |
| power on indication | LED green |
| sensitivity adjustment | Pot, 5 turn |
| laser class | 2 |
| distance to laser focus | 40 mm |
| wave length | 675 nm |

electrical data

| | |
|------------------------------|----------------------|
| response time / release time | < 0,05 ms |
| voltage supply range +Vs | 10 ... 30 VDC |
| current consumption max. | 50 mA |
| current consumption typ. | 40 mA |
| voltage drop Vd | < 1,8 VDC |
| output function | light / dark operate |
| output current | < 100 mA |
| short circuit protection | yes |
| reverse polarity protection | yes |

mechanical data

| | |
|------------------|---------------|
| width / diameter | 10,4 mm |
| height / length | 27 mm |
| depth | 16,3 mm |
| type | rectangular |
| housing material | plastic (ASA) |
| front (optics) | PMMA |

ambient conditions

| | |
|-----------------------|----------------|
| operating temperature | -10 ... +50 °C |
|-----------------------|----------------|

connection diagrams

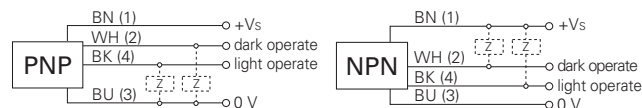

connectors

| | | |
|--------------|-------|--------------|
| ESG 32AH0200 | 4 pin | 2 m straight |
| ESW 31AH0200 | 4 pin | 2 m angular |

additional cable connectors and field wireable connectors, see accessories

accessories

| | |
|-----------------------------------|--------|
| SENSOFIX mounting kit | 150326 |
| mounting bracket (cable type) | 114501 |
| mounting bracket (connector type) | 133792 |

for details, see accessories section

laser warning



| order reference | connection types | output circuit | protection class |
|-------------------|---------------------|----------------|------------------|
| OZDK 10N5101 | cable 4 pin | NPN | IP 65 |
| OZDK 10N5101/S35A | connector M8, 4 pin | NPN | IP 67 |
| OZDK 10P5101 | cable 4 pin | PNP | IP 65 |
| OZDK 10P5101/S35A | connector M8, 4 pin | PNP | IP 67 |

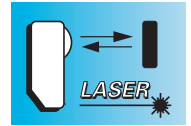

relative receiving signal

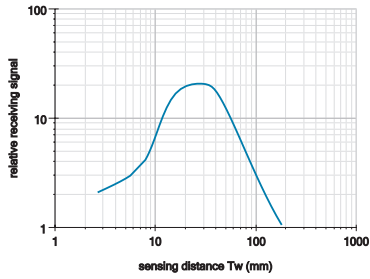

beam characteristic

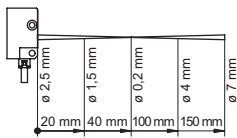

dimension drawings

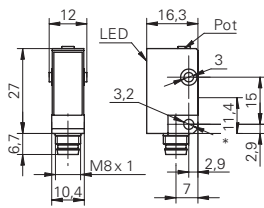

* emitter axis

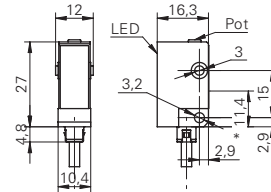

* emitter axis

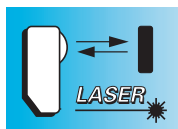

Tw = 3 ... 150 mm

- subminiature housing
- high repeatability
- very short response time



general data

| | |
|----------------------------|-------------------------|
| type | intensity difference |
| version | line beam |
| light source | pulsed red laser diode |
| sensing distance Tw | 3 ... 150 mm |
| optimum operating distance | 35 ... 45 mm |
| repeatability | < 0,2 mm at laser focus |
| light indicator | LED yellow |
| power on indication | LED green |
| sensitivity adjustment | Pot, 5 turn |
| laser class | 2 |
| distance to laser focus | 40 mm |
| wave length | 675 nm |

electrical data

| | |
|------------------------------|----------------------|
| response time / release time | < 0,05 ms |
| voltage supply range +Vs | 10 ... 30 VDC |
| current consumption max. | 50 mA |
| current consumption typ. | 40 mA |
| voltage drop Vd | < 1,8 VDC |
| output function | light / dark operate |
| output current | < 100 mA |
| short circuit protection | yes |
| reverse polarity protection | yes |

mechanical data

| | |
|------------------|---------------|
| width / diameter | 10,4 mm |
| height / length | 27 mm |
| depth | 16,3 mm |
| type | rectangular |
| housing material | plastic (ASA) |
| front (optics) | PMMA |

ambient conditions

| | |
|-----------------------|----------------|
| operating temperature | -10 ... +50 °C |
|-----------------------|----------------|

connection diagrams



connectors

| | | |
|--------------|-------|--------------|
| ESG 32AH0200 | 4 pin | 2 m straight |
| ESW 31AH0200 | 4 pin | 2 m angular |

additional cable connectors and field wireable connectors, see accessories

accessories

| | |
|-----------------------------------|--------|
| SENSOFIX mounting kit | 150326 |
| mounting bracket (cable type) | 114501 |
| mounting bracket (connector type) | 133792 |

for details, see accessories section

laser warning



| order reference | connection types | output circuit | protection class |
|-------------------|---------------------|----------------|------------------|
| OZDK 10N5150 | cable 4 pin | NPN | IP 65 |
| OZDK 10N5150/S35A | connector M8, 4 pin | NPN | IP 67 |
| OZDK 10P5150 | cable 4 pin | PNP | IP 65 |
| OZDK 10P5150/S35A | connector M8, 4 pin | PNP | IP 67 |

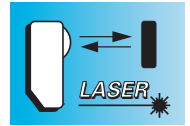

relative receiving signal

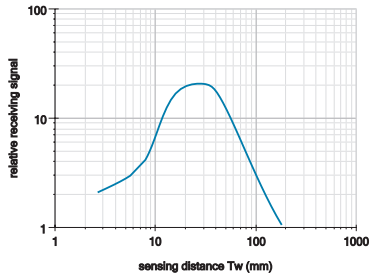

beam characteristic

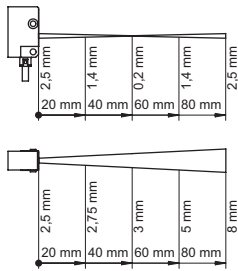

dimension drawings

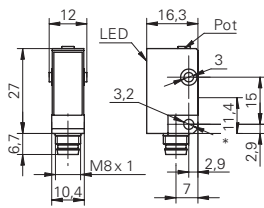

* emitter axis

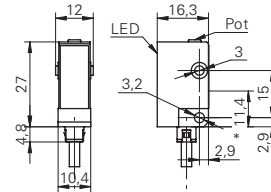

* emitter axis

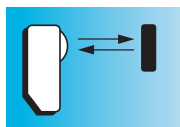

Tw = 30 ... 250 mm

- rugged miniature metal housing
- sensing distance adjustable via potentiometer



general data

| | |
|-----------------------------------|--------------------------|
| type | intensity difference |
| light source | pulsed infrared diode |
| sensing distance Tw | 30 ... 250 mm |
| alignment / soiled lens indicator | flashing light indicator |
| light indicator | LED yellow |
| sensitivity adjustment | Pot, 5 turn |
| wave length | 880 nm |

electrical data

| | |
|------------------------------|----------------------|
| response time / release time | < 1 ms |
| voltage supply range +Vs | 10 ... 30 VDC |
| current consumption max. | 35 mA |
| current consumption typ. | 25 mA |
| voltage drop Vd | < 1,8 VDC |
| output function | light / dark operate |
| output current | < 100 mA |
| short circuit protection | yes |
| reverse polarity protection | yes |

mechanical data

| | |
|------------------|---------------|
| width / diameter | 12,4 mm |
| height / length | 35 mm |
| depth | 35 mm |
| type | rectangular |
| housing material | die-cast zinc |
| front (optics) | PMMA |

ambient conditions

| | |
|-----------------------|----------------|
| operating temperature | -25 ... +65 °C |
| protection class | IP 67 |

connection diagrams

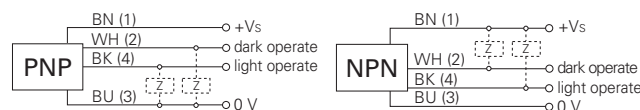

connectors

| | | |
|--------------|-------|--------------|
| ESG 32AH0200 | 4 pin | 2 m straight |
| ESW 31AH0200 | 4 pin | 2 m angular |

additional cable connectors and field wireable connectors, see accessories

accessories

| | |
|-----------------------|--------|
| SENSOFIX mounting kit | 150328 |
| mounting bracket | 113873 |

for details, see accessories section

| order reference | connection types | output circuit |
|-------------------|---------------------|----------------|
| FZDM 12N5101 | cable 4 pin | NPN |
| FZDM 12N5101/S35A | connector M8, 4 pin | NPN |
| FZDM 12P5101 | cable 4 pin | PNP |
| FZDM 12P5101/S35A | connector M8, 4 pin | PNP |

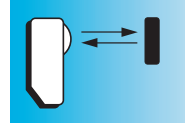

relative receiving signal

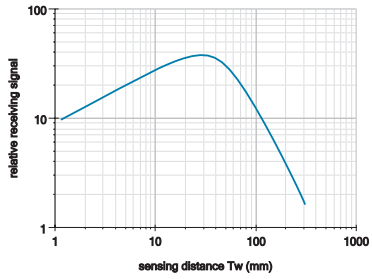

dimension drawings

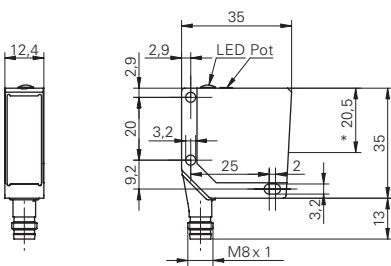

* emitter axis

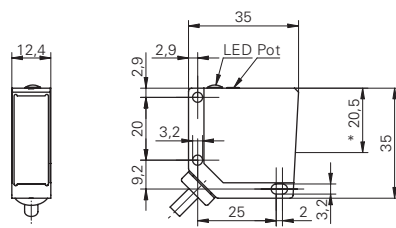

* emitter axis

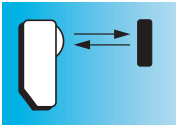

$T_w = 30 \dots 200 \text{ mm}$

- rugged metal housing
- sensing distance adjustable via potentiometer
- suppression of mutual optical interference



general data

| | |
|-------------------------------------|--------------------------|
| type | intensity difference |
| light source | pulsed infrared diode |
| sensing distance T_w | 30 ... 200 mm |
| alignment / soiled lens indicator | flashing light indicator |
| light indicator | LED yellow |
| sensitivity adjustment | Pot, 270° |
| wave length | 880 nm |
| suppression of reciprocal influence | yes |

electrical data

| | |
|------------------------------|---------------|
| response time / release time | < 1 ms |
| voltage supply range +Vs | 10 ... 30 VDC |
| current consumption max. | 42 mA |
| current consumption typ. | 24 mA |
| voltage drop Vd | < 1,8 VDC |
| output current | < 200 mA |
| short circuit protection | yes |
| reverse polarity protection | yes |

mechanical data

| | |
|------------------|---------------------|
| width / diameter | 12 mm |
| type | cylindrical |
| housing material | brass nickel plated |
| front (optics) | PC |

ambient conditions

| | |
|-----------------------|----------------|
| operating temperature | -25 ... +65 °C |
| protection class | IP 65 |

connection diagrams

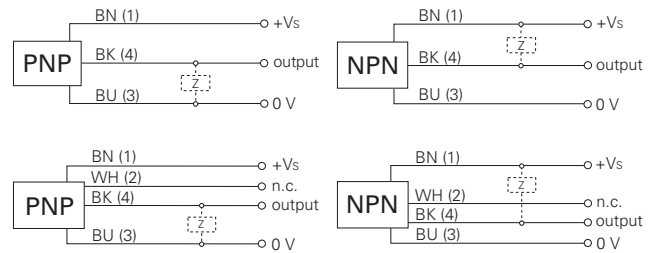

connectors

| | | |
|--------------|-------|--------------|
| ESG 34AH0200 | 4 pin | 2 m straight |
| ESW 33AH0200 | 4 pin | 2 m angular |

additional cable connectors and field wireable connectors, see accessories

accessories

| | |
|-----------------------|--------|
| SENSOFIX mounting kit | 151720 |
|-----------------------|--------|

for details, see accessories section

| order reference | height / length | connection types | output circuit | output function |
|------------------|-----------------|----------------------|----------------|-----------------|
| FZAM 12N1104 | 70 mm | cable 3 pin | NPN | light operate |
| FZAM 12N1104/S14 | 80 mm | connector M12, 4 pin | NPN | light operate |
| FZAM 12N3104 | 70 mm | cable 3 pin | NPN | dark operate |
| FZAM 12N3104/S14 | 80 mm | connector M12, 4 pin | NPN | dark operate |
| FZAM 12P1104 | 70 mm | cable 3 pin | PNP | light operate |
| FZAM 12P1104/S14 | 80 mm | connector M12, 4 pin | PNP | light operate |
| FZAM 12P3104 | 70 mm | cable 3 pin | PNP | dark operate |
| FZAM 12P3104/S14 | 80 mm | connector M12, 4 pin | PNP | dark operate |

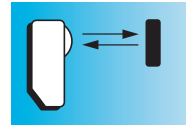

relative receiving signal

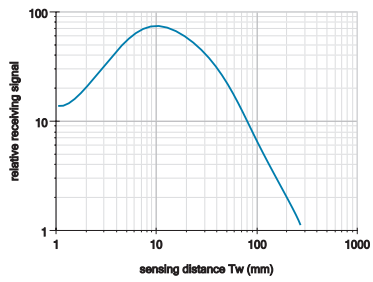

dimension drawings

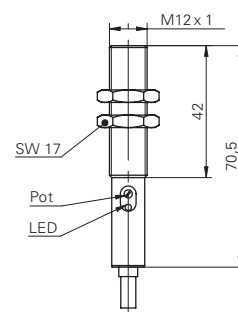
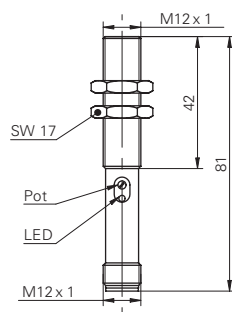

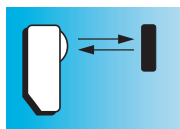

Tw = 5 ... 600 mm

- long sensing range
- sensing distance adjustable via potentiometer
- suppression of mutual optical interference



general data

| | |
|-------------------------------------|--------------------------|
| type | intensity difference |
| light source | pulsed red LED |
| sensing distance Tw | 5 ... 600 mm |
| alignment / soiled lens indicator | flashing light indicator |
| light indicator | LED yellow |
| sensitivity adjustment | Pot, 270° |
| wave length | 660 nm |
| suppression of reciprocal influence | yes |

electrical data

| | |
|------------------------------|----------------------|
| response time / release time | < 1 ms |
| voltage supply range +Vs | 10 ... 30 VDC |
| current consumption max. | 25 mA |
| current consumption typ. | 20 mA |
| voltage drop Vd | < 1,8 VDC |
| output function | light / dark operate |
| output current | < 100 mA |
| short circuit protection | yes |
| reverse polarity protection | yes |

mechanical data

| | |
|------------------|---------------------|
| width / diameter | 14,8 mm |
| height / length | 43 mm |
| depth | 31 mm |
| type | rectangular |
| housing material | plastic (PA12) |
| front (optics) | PA |
| connection types | connector M8, 4 pin |

ambient conditions

| | |
|-----------------------|----------------|
| operating temperature | -25 ... +65 °C |
| protection class | IP 67 |

order reference **output circuit**

| | |
|-------------------|-----|
| FZDK 14N5101/S35A | NPN |
| FZDK 14P5101/S35A | PNP |

connection diagrams



connectors

| | | |
|--------------|-------|--------------|
| ESG 32AH0200 | 4 pin | 2 m straight |
| ESW 31AH0200 | 4 pin | 2 m angular |

additional cable connectors and field wireable connectors, see accessories

accessories

| | |
|-----------------------|--------|
| SENSOFIX mounting kit | 149011 |
| mounting bracket | 134964 |

for details, see accessories section

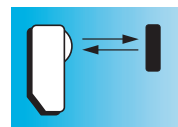

relative receiving signal

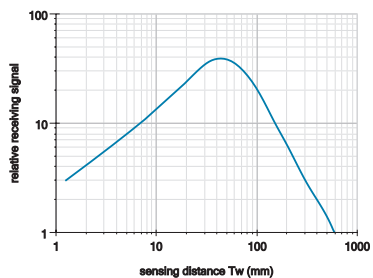

dimension drawing

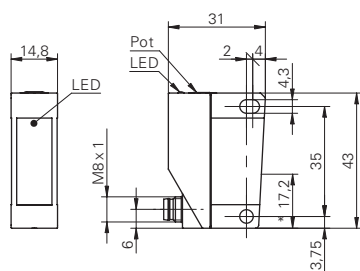

* emitter axis

FZDK 14 Tw = 5 ... 600 mm

Diffuse sensors with intensity difference

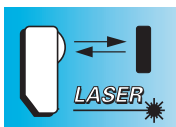

Tw = 20 ... 300 mm



- very short response time
- high repeatability
- sensing distance adjustable via Teach-in

general data

| | |
|-----------------------------------|--------------------------|
| type | intensity difference |
| light source | pulsed red laser diode |
| sensing distance Tw | 20 ... 300 mm |
| repeatability | < 0,2 mm at laser focus |
| alignment / soiled lens indicator | flashing light indicator |
| light indicator | LED yellow |
| power on indication | LED green |
| sensitivity adjustment | Teach-in |
| laser class | 2 |
| distance to laser focus | 115 mm |
| wave length | 650 nm |

electrical data

| | |
|------------------------------|---------------|
| response time / release time | < 0,15 ms |
| voltage supply range +Vs | 10 ... 30 VDC |
| current consumption max. | 35 mA |
| current consumption typ. | 25 mA |
| voltage drop Vd | < 2,2 VDC |
| output function | light operate |
| output current | < 100 mA |
| short circuit protection | yes |
| reverse polarity protection | yes |

mechanical data

| | |
|------------------|---------------------|
| width / diameter | 14,8 mm |
| height / length | 43 mm |
| depth | 31 mm |
| type | rectangular |
| housing material | plastic (PA12) |
| front (optics) | PMMA |
| connection types | connector M8, 4 pin |

ambient conditions

| | |
|-----------------------|----------------|
| operating temperature | -10 ... +50 °C |
| protection class | IP 67 |

order reference

| |
|-------------------|
| OZDK 14N1901/S35A |
| OZDK 14P1901/S35A |

output circuit

| |
|-----|
| NPN |
| PNP |

connection diagrams



connectors

| | | |
|--------------|-------|--------------|
| ESG 32AH0200 | 4 pin | 2 m straight |
| ESW 31AH0200 | 4 pin | 2 m angular |

additional cable connectors and field wireable connectors, see accessories

accessories

| | |
|-----------------------|--------|
| SENSOFIX mounting kit | 149011 |
| mounting bracket | 134964 |

for details, see accessories section

laser warning



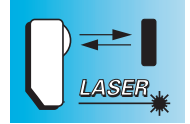

relative receiving signal

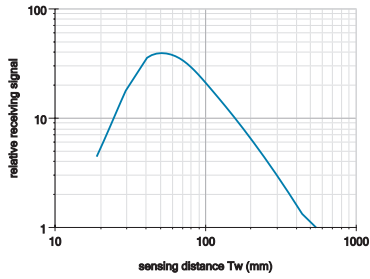

beam characteristic

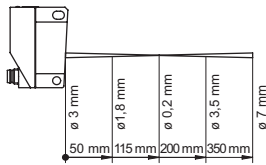

dimension drawing

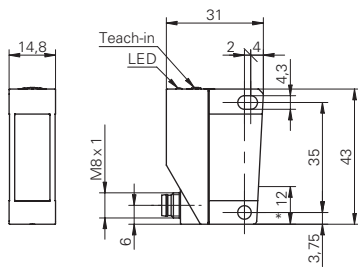

* emitter axis

OZDK 14 Tw = 20 ... 300 mm
Diffuse sensors with intensity difference

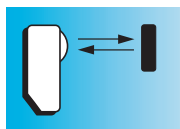

$T_w = 0 \dots 400 \text{ mm}$

- rugged metal housing
- sensing distance adjustable via potentiometer



general data

| | |
|-------------------------------------|--------------------------|
| type | intensity difference |
| light source | pulsed infrared diode |
| sensing distance T_w | 0 ... 400 mm |
| alignment / soiled lens indicator | flashing light indicator |
| light indicator | LED yellow |
| sensitivity adjustment | Pot, 270° |
| wave length | 880 nm |
| suppression of reciprocal influence | yes |

electrical data

| | |
|------------------------------|----------------------|
| response time / release time | < 1 ms |
| voltage supply range +Vs | 10 ... 30 VDC |
| current consumption max. | 41 mA |
| current consumption typ. | 29 mA |
| voltage drop Vd | < 1,8 VDC |
| output function | light / dark operate |
| output current | < 200 mA |
| short circuit protection | yes |
| reverse polarity protection | yes |

mechanical data

| | |
|------------------|---------------|
| width / diameter | 15,4 mm |
| height / length | 50 mm |
| depth | 50 mm |
| type | rectangular |
| housing material | die-cast zinc |
| front (optics) | PMMA |

ambient conditions

| | |
|-----------------------|----------------|
| operating temperature | -25 ... +65 °C |
| protection class | IP 67 |

connection diagrams



connectors

| | | |
|--------------|-------|--------------|
| ESG 34AH0200 | 4 pin | 2 m straight |
| ESW 33AH0200 | 4 pin | 2 m angular |

additional cable connectors and field wireable connectors, see accessories

accessories

| | |
|-----------------------|--------|
| SENSOFIX mounting kit | 151721 |
| mounting bracket | 113917 |

for details, see accessories section

| order reference | connection types | output circuit |
|------------------|----------------------|----------------|
| FZDM 16N5101 | cable 4 pin | NPN |
| FZDM 16N5101/S14 | connector M12, 4 pin | NPN |
| FZDM 16P5101 | cable 4 pin | PNP |
| FZDM 16P5101/S14 | connector M12, 4 pin | PNP |

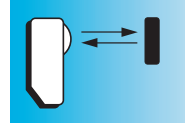

relative receiving signal

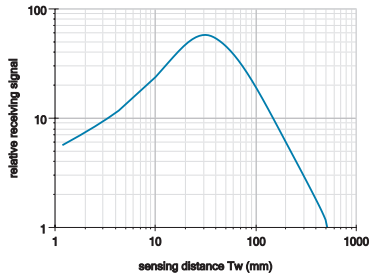

dimension drawings

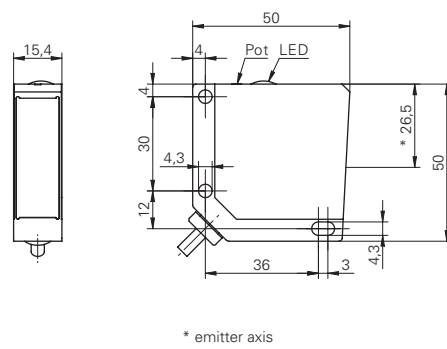
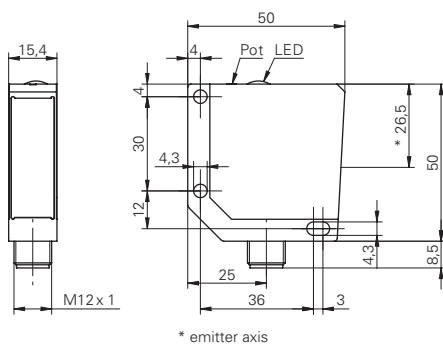

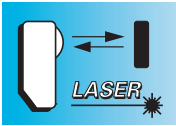

Tw = 0 ... 250 mm

- rugged metal housing
- high repeatability
- very short response time



OZDM 16 Tw = 0 ... 250 mm

general data

| | |
|---|-------------------------|
| type | intensity difference |
| light source | pulsed red laser diode |
| sensing distance Tw | 0 ... 250 mm |
| optimum operating distance | 40 ... 80 mm |
| detectable remission difference (on grey) | > 8 % |
| repeatability | < 0,1 mm at laser focus |
| output indicator | LED yellow |
| sensitivity adjustment | Pot, 14 turn |
| laser class | 2 |
| distance to laser focus | 80 mm |
| wave length | 675 nm |

electrical data

| | |
|------------------------------|---------------|
| response time / release time | < 0,05 ms |
| voltage supply range +Vs | 12 ... 30 VDC |
| current consumption max. | 65 mA |
| current consumption typ. | 60 mA |
| voltage drop Vd | < 1,8 VDC |
| output current | < 200 mA |
| short circuit protection | yes |
| reverse polarity protection | yes |

mechanical data

| | |
|------------------|---------------|
| width / diameter | 15,4 mm |
| height / length | 50 mm |
| depth | 50 mm |
| type | rectangular |
| housing material | die-cast zinc |
| front (optics) | glass |

ambient conditions

| | |
|-----------------------|----------------|
| operating temperature | -10 ... +50 °C |
| protection class | IP 67 |

connection diagrams

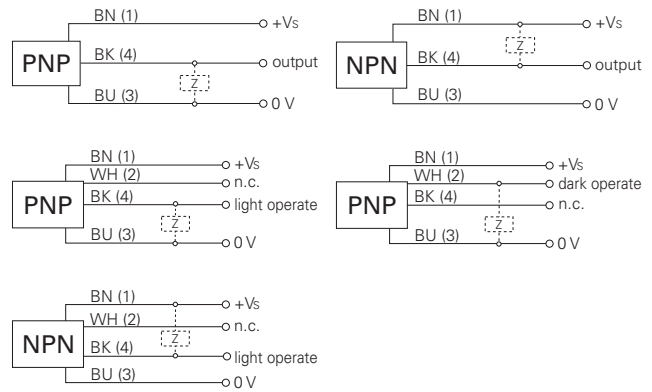

connectors

| | | |
|--------------|-------|--------------|
| ESG 34AH0200 | 4 pin | 2 m straight |
| ESW 33AH0200 | 4 pin | 2 m angular |

additional cable connectors and field wireable connectors, see accessories

accessories

| | |
|----------------------------------|--------|
| SENSOFIX mounting kit | 151721 |
| mounting bracket | 113917 |
| lens cleaning air nozzle bracket | 116407 |

for details, see accessories section

laser warning



| order reference | connection types | output circuit | output function |
|------------------|----------------------|----------------|-----------------|
| OZDM 16N1001 | cable 3 pin | NPN | light operate |
| OZDM 16N1001/S14 | connector M12, 4 pin | NPN | light operate |
| OZDM 16P1001 | cable 3 pin | PNP | light operate |
| OZDM 16P1001/S14 | connector M12, 4 pin | PNP | light operate |
| OZDM 16P3001 | cable 3 pin | PNP | dark operate |
| OZDM 16P3001/S14 | connector M12, 4 pin | PNP | dark operate |

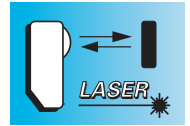

relative receiving signal

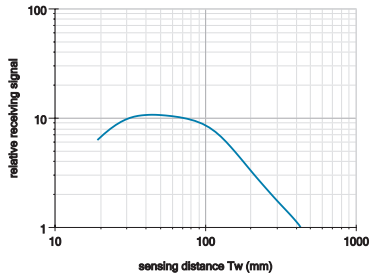

beam characteristic

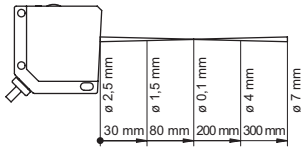

dimension drawings

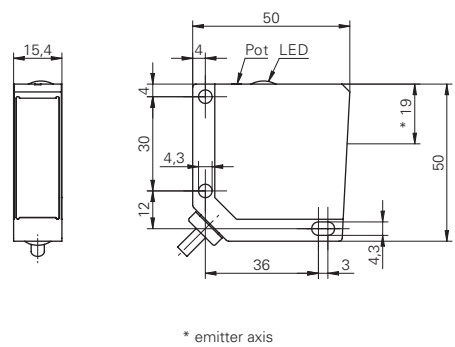
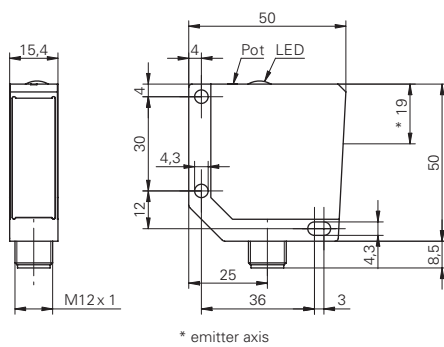

OZDM 16 Tw = 0 ... 250 mm
Diffuse sensors with intensity difference

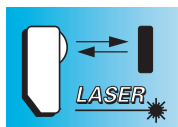

Tw = 0 ... 250 mm

- with analog output
- high repeatability
- very short response time



general data

| | |
|---|-------------------------|
| type | intensity difference |
| light source | pulsed red laser diode |
| sensing distance Tw | 0 ... 250 mm |
| optimum operating distance | 40 ... 80 mm |
| detectable remission difference (on grey) | > 8 % |
| repeatability | < 0,1 mm at laser focus |
| output indicator | LED yellow |
| sensitivity adjustment | Pot, 14 turn |
| laser class | 2 |
| distance to laser focus | 80 mm |
| wave length | 675 nm |

electrical data

| | |
|------------------------------|--------------------------|
| response time / release time | < 0,1 ms |
| voltage supply range +Vs | 12 ... 30 VDC |
| current consumption max. | 65 mA |
| current consumption typ. | 60 mA |
| voltage drop Vd | < 1,8 VDC |
| output function | light operate |
| output circuit | PNP / analog 4 ... 20 mA |
| output current | < 200 mA |
| short circuit protection | yes |
| reverse polarity protection | yes |

mechanical data

| | |
|------------------|---------------|
| width / diameter | 15,4 mm |
| height / length | 50 mm |
| depth | 50 mm |
| type | rectangular |
| housing material | die-cast zinc |
| front (optics) | glass |

ambient conditions

| | |
|-----------------------|----------------|
| operating temperature | -10 ... +50 °C |
| protection class | IP 67 |

order reference **connection types**

| | |
|-------------------------|----------------------|
| OZDM 16P1901 | cable 4 pin |
| OZDM 16P1901/S14 | connector M12, 4 pin |

connection diagram

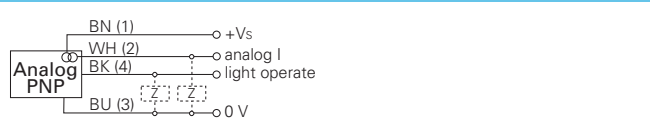

connectors

| | | |
|--------------|-------|--------------|
| ESG 34AH0200 | 4 pin | 2 m straight |
| ESW 33AH0200 | 4 pin | 2 m angular |

additional cable connectors and field wireable connectors, see accessories

accessories

| | |
|----------------------------------|--------|
| SENSOFIX mounting kit | 151721 |
| mounting bracket | 113917 |
| lens cleaning air nozzle bracket | 116407 |

for details, see accessories section

laser warning



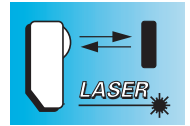

signal progression

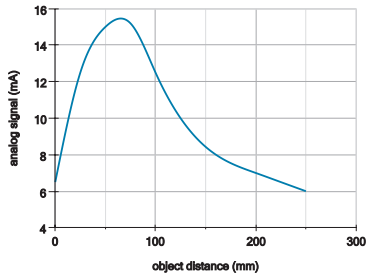

beam characteristic

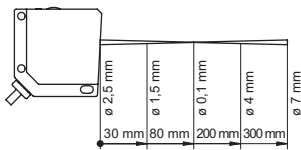

dimension drawings

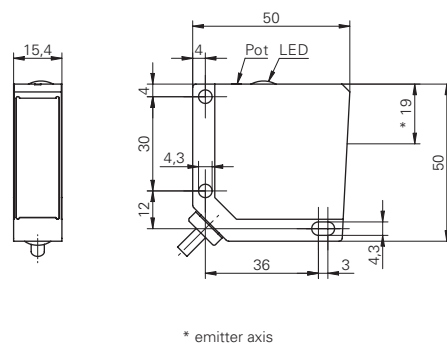
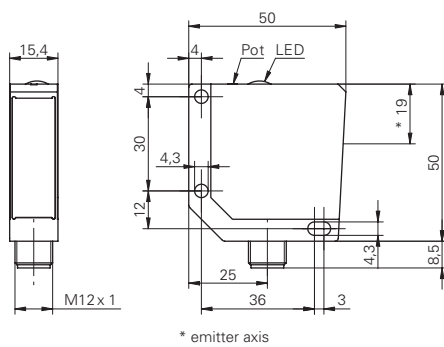

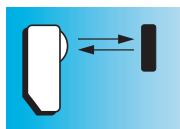

Tw = 60 ... 430 mm

- with alarm output
- sensing distance adjustable via Teach-in
- extended sensing distance with lens



general data

| | |
|--|--------------------------|
| type | intensity difference |
| light source | pulsed infrared diode |
| sensing distance Tw | 60 ... 430 mm |
| alignment / soiled lens indicator | flashing light indicator |
| light indicator | LED green |
| output indicator | LED yellow |
| sensitivity adjustment | Teach-in |
| wave length | 880 nm |
| suppression of reciprocal influence | yes |
| sensing distance Tw (with doubling lens) | 80 ... 800 mm |

electrical data

| | |
|------------------------------|----------------------------|
| response time / release time | < 1 ms |
| voltage supply range +Vs | 10 ... 30 VDC |
| current consumption max. | 55 mA |
| current consumption typ. | 40 mA |
| voltage drop Vd | < 1,8 VDC |
| output function | light / dark operate alarm |
| output current | < 200 mA |
| short circuit protection | yes |
| reverse polarity protection | yes |

mechanical data

| | |
|------------------|--------------------------|
| width / diameter | 18 mm |
| type | cylindrical |
| housing material | brass nickel plated / PC |
| front (optics) | PC |

ambient conditions

| | |
|-----------------------|----------------|
| operating temperature | -25 ... +55 °C |
| protection class | IP 67 |

connection diagrams



connectors

| | | |
|--------------|-------|--------------|
| ESG 34AH0200 | 4 pin | 2 m straight |
| ESW 33AH0200 | 4 pin | 2 m angular |

additional cable connectors and field wireable connectors, see accessories

accessories

| | |
|-----------------------|--------|
| SENSOFIX mounting kit | 151658 |
| glass cover | 103068 |
| doubling lens | 107250 |
| cap nut | 115913 |

for details, see accessories section

remarks

With doubling lens / cap nut, the sensing distance can be doubled.

| order reference | height / length | connection types | output circuit |
|------------------|-----------------|----------------------|----------------|
| FZAM 18N6460 | 50 mm | cable 4 pin | NPN |
| FZAM 18N6460/S14 | 60 mm | connector M12, 4 pin | NPN |
| FZAM 18P6460 | 50 mm | cable 4 pin | PNP |
| FZAM 18P6460/S14 | 60 mm | connector M12, 4 pin | PNP |

FZAM 18 Tw = 60 ... 430 mm

Diffuse sensors with intensity difference

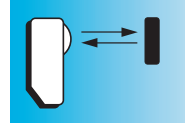

relative receiving signal

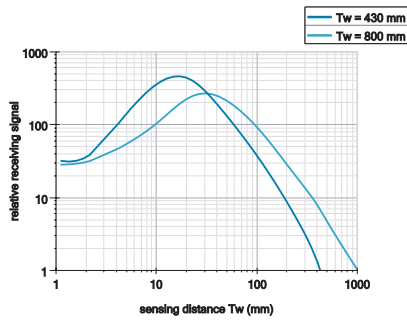

dimension drawings

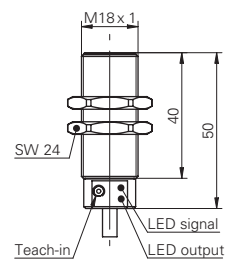
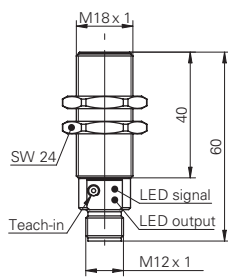

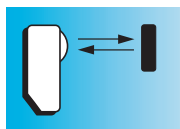

Tw = 20 ... 150 mm

- rugged metal housing
- sensing distance adjustable with potentiometer (axial)
- extended sensing distance with lens



general data

| | |
|--|--------------------------|
| type | intensity difference |
| light source | pulsed infrared diode |
| sensing distance Tw | 20 ... 150 mm |
| alignment / soiled lens indicator | flashing light indicator |
| light indicator | LED yellow |
| sensitivity adjustment | Pot, 15 turn |
| wave length | 880 nm |
| suppression of reciprocal influence | yes |
| sensing distance Tw (with doubling lens) | 30 ... 280 mm |

electrical data

| | |
|------------------------------|---------------|
| response time / release time | < 0,5 ms |
| voltage supply range +Vs | 10 ... 30 VDC |
| current consumption max. | 45 mA |
| current consumption typ. | 30 mA |
| voltage drop Vd | < 1,8 VDC |
| output function | light operate |
| output current | < 200 mA |
| short circuit protection | yes |
| reverse polarity protection | yes |

mechanical data

| | |
|------------------|--------------------------|
| width / diameter | 18 mm |
| height / length | 50 mm |
| type | cylindrical |
| housing material | brass nickel plated / PC |
| front (optics) | PC |
| connection types | cable 3 pin |

ambient conditions

| | |
|-----------------------|----------------|
| operating temperature | -25 ... +55 °C |
| protection class | IP 65 |

| order reference | output circuit |
|-----------------|----------------|
|-----------------|----------------|

| | |
|--------------|-----|
| FZAM 18N1155 | NPN |
| FZAM 18P1155 | PNP |

connection diagrams

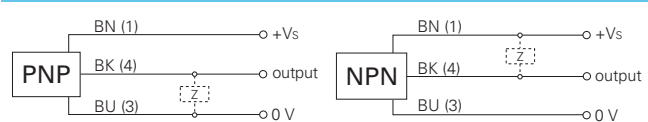

accessories

| | |
|-----------------------|--------|
| SENSOFIX mounting kit | 151658 |
| glass cover | 103068 |
| doubling lens | 107250 |
| cap nut | 115913 |

for details, see accessories section

remarks

With doubling lens / cap nut, the sensing distance can be doubled.

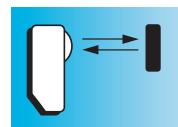

relative receiving signal

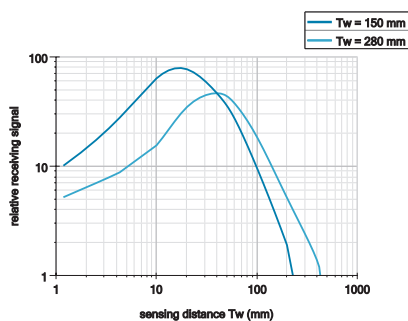

dimension drawing

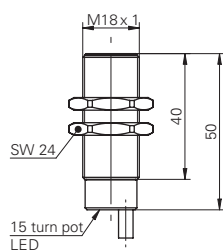

FZAM 18 Tw = 20 ... 150 mm

Diffuse sensors with intensity difference

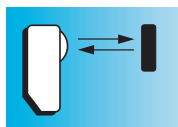

Tw = 60 ... 430 mm



- rugged metal housing
- sensing distance adjustable with radially mounted potentiometer

general data

| | |
|--|--------------------------|
| type | intensity difference |
| light source | pulsed infrared diode |
| sensing distance Tw | 60 ... 430 mm |
| alignment / soiled lens indicator | flashing light indicator |
| light indicator | LED yellow |
| sensitivity adjustment | Pot, 270° |
| wave length | 880 nm |
| suppression of reciprocal influence | yes |
| sensing distance Tw (with doubling lens) | 80 ... 800 mm |

electrical data

| | |
|------------------------------|---------------|
| response time / release time | < 1 ms |
| voltage supply range +Vs | 10 ... 30 VDC |
| current consumption max. | 45 mA |
| current consumption typ. | 30 mA |
| voltage drop Vd | < 1,8 VDC |
| output function | light operate |
| output current | < 200 mA |
| short circuit protection | yes |
| reverse polarity protection | yes |

mechanical data

| | |
|------------------|--------------------------|
| width / diameter | 18 mm |
| type | cylindrical |
| housing material | brass nickel plated / PC |
| front (optics) | PC |

ambient conditions

| | |
|-----------------------|----------------|
| operating temperature | -25 ... +55 °C |
| protection class | IP 67 |

connection diagrams

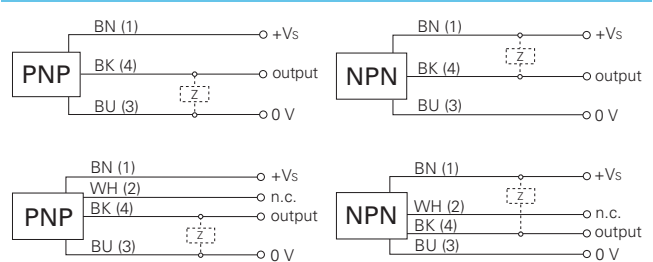

connectors

| | | |
|--|-------|--------------|
| ESG 34AH0200 | 4 pin | 2 m straight |
| ESW 33AH0200 | 4 pin | 2 m angular |
| additional cable connectors and field wireable connectors, see accessories | | |

accessories

| | |
|--------------------------------------|--------|
| SENSOFIX mounting kit | 151658 |
| glass cover | 103068 |
| doubling lens | 107250 |
| cap nut | 115913 |
| for details, see accessories section | |

remarks

With doubling lens / cap nut, the sensing distance can be doubled.

| order reference | height / length | connection types | output circuit |
|------------------|-----------------|----------------------|----------------|
| FZAM 18N1150 | 50 mm | cable 3 pin | NPN |
| FZAM 18N1150/S14 | 60 mm | connector M12, 4 pin | NPN |
| FZAM 18P1150 | 50 mm | cable 3 pin | PNP |
| FZAM 18P1150/S14 | 60 mm | connector M12, 4 pin | PNP |

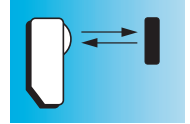

relative receiving signal

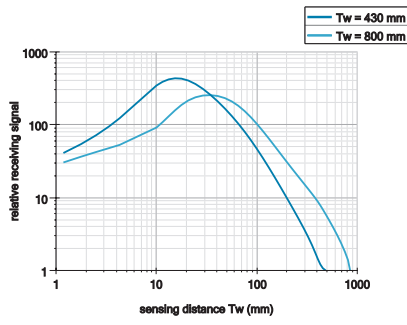

dimension drawings

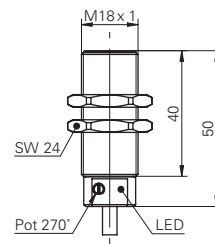
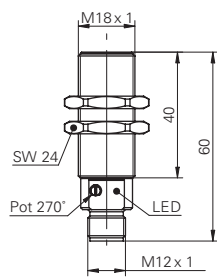

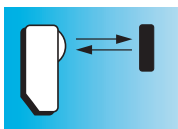

Tw = 5 ... 500 mm

- cross-technology housing concept
- sensing distance adjustable via potentiometer
- small mounting depth



general data

| | |
|-------------------------------------|--------------------------|
| type | intensity difference |
| light source | pulsed red LED |
| sensing distance Tw | 5 ... 500 mm |
| alignment / soiled lens indicator | flashing light indicator |
| light indicator | LED yellow |
| sensitivity adjustment | Pot, 270° |
| wave length | 660 nm |
| suppression of reciprocal influence | yes |

electrical data

| | |
|------------------------------|----------------------|
| response time / release time | < 0,5 ms |
| voltage supply range +Vs | 10 ... 30 VDC |
| current consumption max. | 25 mA |
| current consumption typ. | 22 mA |
| voltage drop Vd | < 1,8 VDC |
| output function | light / dark operate |
| output current | < 100 mA |
| short circuit protection | yes |
| reverse polarity protection | yes |

mechanical data

| | |
|------------------|---------------------|
| width / diameter | 20 mm |
| height / length | 42 mm |
| depth | 15 mm |
| type | rectangular |
| housing material | plastic (PBT-ASA) |
| front (optics) | PMMA |
| connection types | connector M8, 4 pin |

ambient conditions

| | |
|-----------------------|----------------|
| operating temperature | -25 ... +65 °C |
| protection class | IP 67 |

order reference output circuit

| | |
|-------------------|-----|
| FZDK 20N5101/S35A | NPN |
| FZDK 20P5101/S35A | PNP |

connection diagrams



connectors

| | | |
|--------------|-------|--------------|
| ESG 32AH0200 | 4 pin | 2 m straight |
| ESW 31AH0200 | 4 pin | 2 m angular |

additional cable connectors and field wireable connectors, see accessories

accessories

| | |
|-----------------------|--------|
| SENSOFIX mounting kit | 150326 |
|-----------------------|--------|

for details, see accessories section

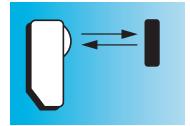

relative receiving signal

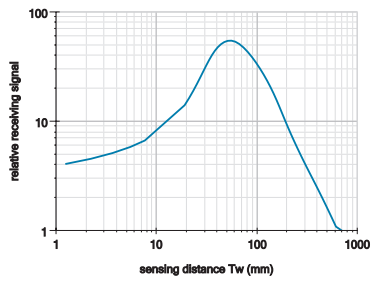

dimension drawing

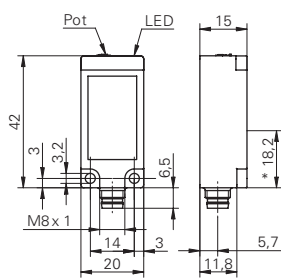

* emitter axis

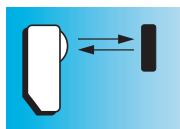

Tw = 100 ... 1500 mm



- rugged metal housing
- long sensing range

general data

| | |
|-----------------------------------|--------------------------|
| type | intensity difference |
| light source | pulsed infrared diode |
| alignment / soiled lens indicator | flashing light indicator |
| light indicator | LED yellow |
| sensitivity adjustment | Pot, 15 turn |
| wave length | 880 nm |

electrical data

| | |
|-----------------------------|----------------------|
| voltage supply range +Vs | 10 ... 30 VDC |
| current consumption max. | 60 mA |
| current consumption typ. | 50 mA |
| voltage drop Vd | < 2,5 VDC |
| output function | light / dark operate |
| output current | < 100 mA |
| short circuit protection | yes |
| reverse polarity protection | yes |

mechanical data

| | |
|------------------|---------------------|
| width / diameter | 30 mm |
| height / length | 66 mm |
| type | cylindrical |
| housing material | brass nickel plated |
| front (optics) | PC |
| connection types | cabl 4 pin |

ambient conditions

| | |
|-----------------------|--------------|
| operating temperature | 0 ... +65 °C |
| protection class | IP 65 |

connection diagrams



accessories

| | |
|--------------------------------------|--------|
| glass cover | 103226 |
| doubling lens | 107408 |
| cap nut | 102801 |
| for details, see accessories section | |

| order reference | sensing distance Tw | output circuit | response time / release time |
|-----------------|---------------------|----------------|------------------------------|
| FZAM 30N5002 | 300 ... 1500 mm | NPN | < 2,5 ms |
| FZAM 30N5003 | 100 ... 700 mm | NPN | < 0,25 ms |
| FZAM 30P5002 | 300 ... 1500 mm | PNP | < 2,5 ms |
| FZAM 30P5003 | 100 ... 700 mm | PNP | < 0,25 ms |

FZAM 30 Tw = 100 ... 1500 mm

Diffuse sensors with intensity difference

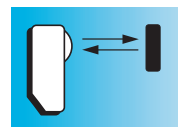

relative receiving signal

Tw = 300 ... 1500 mm

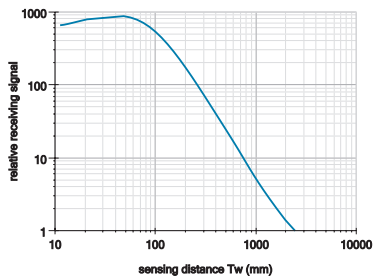

Tw = 100 ... 700 mm

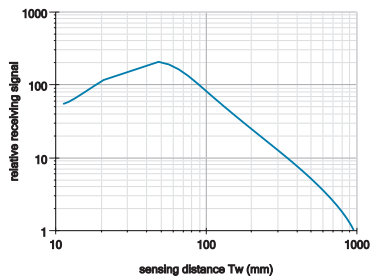



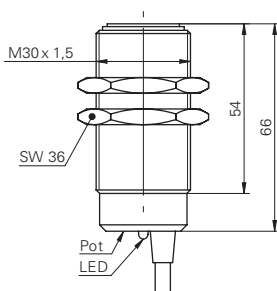



dimension drawing



FZAM 30 Tw = 100 ... 1500 mm

Diffuse sensors with intensity difference

| product family | FFAK 17 | FFAK 17 | FFAK 16 | FFAM 17 | FFAM 16 | FFDK 16 | FODK 23 |
|------------------------------|---|---|---|---|---|---|---|
| |  |  |  |  |  |  |  |
| width / diameter | 30 mm | 30 mm | 30 mm | 30 mm | 30 mm | 16 mm | 23 mm |
| response time / release time | | | | | | < 2 ms | < 1 ms |
| sensitivity adjustment | no | Pot | no | Pot | Pot | no | no |
| NPN | ■ | ■ | ■ | | | | |
| PNP | ■ | ■ | ■ | ■ | ■ | ■ | ■ |
| cable | ■ | ■ | ■ | ■ | ■ | ■ | ■ |
| housing material | plastic | plastic | plastic | metal | metal | plastic | plastic |
| Page | 344 | 345 | 346 | 347 | 348 | 349 | 350 |



General information

With optical level monitoring and leak sensors, liquids can be easily and reliably detected without the need of an electrical connection or mechanical movement between the liquid and the sensor. There are two possible principles of detection: the sensor is in direct contact with the liquid or it is fastened to a hose or stand pipe to detect the level without contact. The available fiber optic versions permit level and leak control in constricted surroundings and even in hazardous zones.



Typical applications

The chemical resistance of the sensors permits versatile applications:

- Level monitoring of liquids such as
 - acetone
 - alkalis
 - milk
 - acids, e.g. hydrochloric, sulfuric or battery acid
 - mineral oil
 - all non-conductive liquids
- Contact free level detection in (semi) transparent hoses and stand pipes
- Detection of the minimum and maximum levels in trays and tanks
- Leak monitoring of oil trays or lubricant tanks
- Monitoring of leaked liquids in dispensers and other liquid handling systems

Characteristics and advantages of level monitoring sensors

Chemical resistance

The sensor housings are made of polysulfonide or stainless steel and are resistant to certain liquids.

Detectable media

As optical light is used to detect the liquid, various and non-conductive liquids can be detected.

Simple commissioning

It is unnecessary to adjust sensors with integrated electronics. With fiber optics, the adjustment is made via a fiber optic sensor.

Hazardous environments

The intrinsically safe fiber optic version with Teflon PFA coating can also be used in hazardous environments.

Characteristics and advantages of leak sensors

Detectable media

As optical light is used to detect the liquid, various and non-conductive liquids can be detected. Typically, 1ml of leaked liquid is sufficient to initiate an alarm.

Failsafe facility

The integrated failsafe facility triggers an alarm on leaks, cable rupture, detachment from the fastening or if the sensor is defective.

Hazardous environments

The intrinsically safe fiber optic version with Teflon PFA coating can also be used in hazardous environments.



Technology and operation

Level monitoring and leak sensors in contact with the liquid

The operating principles of both types of sensor are shown in the sketch below. The critical angle for total reflection changes depending on whether the sensor tip is surrounded by water or air. If the sensor tip is surrounded by a liquid, the light beam is refracted by the liquid and the sensor output changes its state. The liquid medium may be electrically conductive, turbid or clear. The same operating principle is employed for the leak sensors. Only the volume of the liquid is different. Typically, as little as 1ml of a liquid can be detected.

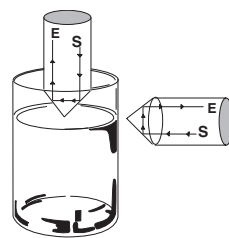

Level not reached

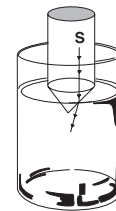

Level reached

Level monitoring sensors without contact with the liquid

The level monitoring sensors for hose or stand pipe mounting operate by a similar principle. For example, the FFDK 16 also exploits the refractive properties of liquids. In a state without the liquid, the emitted light (A) impinges directly on the receiver (B). If the liquid enters the detection range, a part of the emitted light is refracted, so that less light impinges on the receiver. This change in the light can be assessed by the sensor.

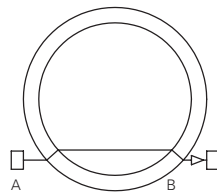

Level not reached

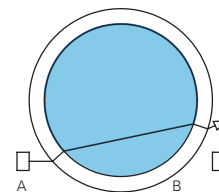

Level reached

With the fiber optic version FSL 500C6Y00, the principle is exactly the opposite. In a state without the liquid, no light impinges on the receiver (B). It is only when liquid enters the detection range of the array that a part of the emitted light (A) is diverted to the receiver (B). This change in the light can be assessed by the receiver. The advantage of the array configuration with a monitoring range of approx. 5 mm is that interference caused by foam and small air bubbles can be suppressed by a powerful fiber optic sensor.

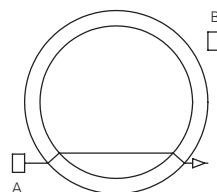

Level not reached

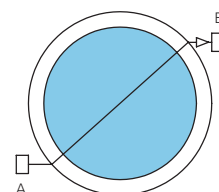

Level reached



Mounting and adjustment

Level monitoring sensors for hose/stand pipe mounting:

The sensors can very easily be attached to a hose or stand pipe with cable ties. A separate bracket or other holder is unnecessary. No adjustments must be made to the FFDK 16 with integrated electronics. It is only necessary to choose between light and dark switching. With the fiber optic version FSL, the adjustment is made via a fiber optic sensor.



Leak sensors:

The leak sensors can be screwed directly to the floor or on a base. No adjustments must be made to the sensor FODK 23. With the fiber optic version FOC, the adjustment is made via a fiber optic sensor. The sensors can be very easily released from their holders for cleaning purposes move to beginning of sentence.

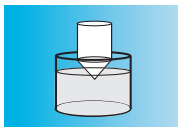

- chemical resistance
- up to 10 bar nominal pressure



general data

| | |
|------------------------------|-----------------------|
| type | Liquid level sensor |
| light source | pulsed infrared diode |
| nominal pressure (probe tip) | 10 bar |
| output indicator | LED red |
| sensitivity adjustment | no |
| wave length | 880 nm |

electrical data

| | |
|-----------------------------|--------------------|
| voltage supply range +Vs | 10 ... 30 VDC |
| current consumption max. | 15 mA |
| voltage drop Vd | < 2 VDC |
| output function | normally open (NO) |
| output current | < 200 mA |
| short circuit protection | no |
| reverse polarity protection | yes, Vs to GND |

mechanical data

| | |
|---------------------------|--------------|
| width / diameter | 30 mm |
| height / length | 81 mm |
| type | cylindrical |
| material (sensing device) | polysulphone |
| housing material | polysulphone |
| connection types | cabl 3 pin |

ambient conditions

| | |
|-----------------------|--------------|
| operating temperature | 0 ... +65 °C |
| protection class | IP 67 |

order reference output circuit

| | |
|------------------|-----|
| FFAK 17NTD1001/L | NPN |
| FFAK 17PTD1001/L | PNP |

dimension drawing

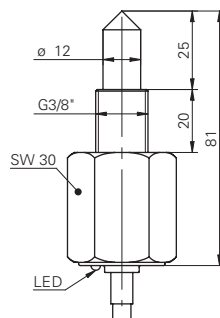

connection diagrams

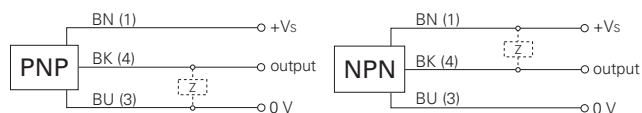

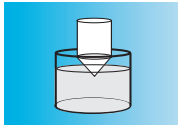

- sensitivity adjustable
- chemical resistance
- up to 10 bar nominal pressure



| general data | |
|------------------------------|-----------------------|
| type | Liquid level sensor |
| light source | pulsed infrared diode |
| nominal pressure (probe tip) | 10 bar |
| output indicator | LED red |
| sensitivity adjustment | Pot |
| wave length | 880 nm |
| electrical data | |
| voltage supply range +Vs | 10 ... 30 VDC |
| current consumption max. | 15 mA |
| voltage drop Vd | < 2 VDC |
| output function | normally open (NO) |
| output current | < 200 mA |
| short circuit protection | no |
| reverse polarity protection | yes, Vs to GND |
| mechanical data | |
| width / diameter | 30 mm |
| height / length | 81,5 mm |
| type | cylindrical |
| material (sensing device) | polysulphone |
| housing material | polysulphone |
| connection types | cable 3 pin |
| ambient conditions | |
| operating temperature | 0 ... +65 °C |
| protection class | IP 67 |

| order reference | output circuit |
|------------------|----------------|
| FFAK 17NTD1002/L | NPN |
| FFAK 17PTD1002/L | PNP |

dimension drawing

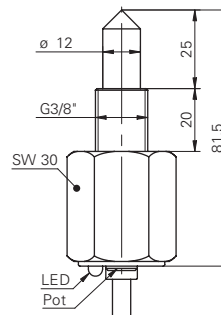

connection diagrams

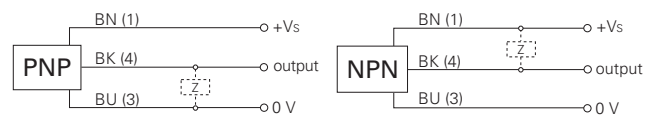

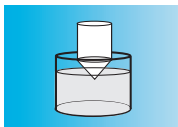

- with thread M16x1
- chemical resistance
- up to 10 bar nominal pressure



general data

| | |
|------------------------------|-----------------------|
| type | Liquid level sensor |
| light source | pulsed infrared diode |
| nominal pressure (probe tip) | 10 bar |
| output indicator | LED red |
| sensitivity adjustment | no |
| wave length | 880 nm |

electrical data

| | |
|-----------------------------|--------------------|
| voltage supply range +Vs | 10 ... 30 VDC |
| current consumption max. | 15 mA |
| voltage drop Vd | < 2 VDC |
| output function | normally open (NO) |
| output current | < 200 mA |
| short circuit protection | no |
| reverse polarity protection | yes, Vs to GND |

mechanical data

| | |
|---------------------------|--------------|
| width / diameter | 30 mm |
| height / length | 81 mm |
| type | cylindrical |
| material (sensing device) | polysulphone |
| housing material | polysulphone |
| connection types | cabl 3 pin |

ambient conditions

| | |
|-----------------------|--------------|
| operating temperature | 0 ... +65 °C |
| protection class | IP 67 |

order reference output circuit

| | |
|------------------|-----|
| FFAK 16NTD1001/L | NPN |
| FFAK 16PTD1001/L | PNP |

dimension drawing

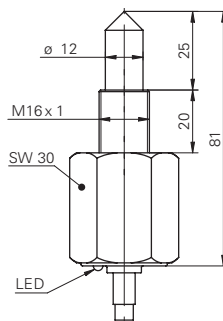

connection diagrams

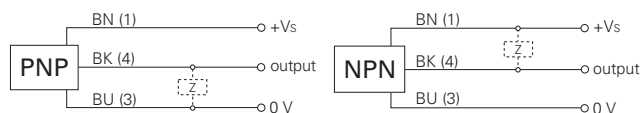

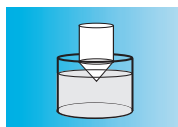

- rugged metal housing
- chemical resistance
- up to 40 bar nominal pressure



general data

| | |
|------------------------------|-----------------------|
| type | Liquid level sensor |
| light source | pulsed infrared diode |
| nominal pressure (probe tip) | 40 bar |
| output indicator | LED yellow |
| sensitivity adjustment | Pot |
| wave length | 880 nm |

electrical data

| | |
|-----------------------------|--------------------|
| voltage supply range +Vs | 10 ... 30 VDC |
| current consumption max. | 15 mA |
| voltage drop Vd | < 2 VDC |
| output function | normally open (NO) |
| output circuit | PNP |
| output current | < 200 mA |
| short circuit protection | no |
| reverse polarity protection | yes, Vs to GND |

mechanical data

| | |
|---------------------------|-------------------------------------|
| width / diameter | 30 mm |
| height / length | 66,5 mm |
| type | cylindrical |
| material (sensing device) | glass (borosilicate) |
| housing material | stainless steel DIN 1.4305/AISI 303 |
| connection types | cable 3 pin |

ambient conditions

| | |
|-----------------------|--------------|
| operating temperature | 0 ... +65 °C |
| protection class | IP 67 |

order reference

FFAM 17PTD1002/L

dimension drawing

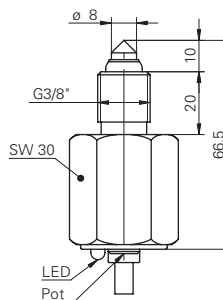

connection diagram

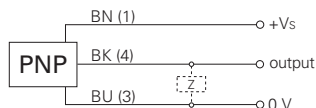

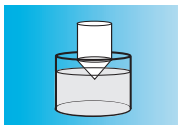

- with thread M16x1
- rugged metal housing
- up to 40 bar nominal pressure



general data

| | |
|------------------------------|-----------------------|
| type | Liquid level sensor |
| light source | pulsed infrared diode |
| nominal pressure (probe tip) | 40 bar |
| output indicator | LED yellow |
| sensitivity adjustment | Pot |
| wave length | 880 nm |

electrical data

| | |
|-----------------------------|--------------------|
| voltage supply range +Vs | 10 ... 30 VDC |
| current consumption max. | 15 mA |
| voltage drop Vd | < 2 VDC |
| output function | normally open (NO) |
| output circuit | PNP |
| output current | < 200 mA |
| short circuit protection | no |
| reverse polarity protection | yes, Vs to GND |

mechanical data

| | |
|---------------------------|-------------------------------------|
| width / diameter | 30 mm |
| height / length | 66,5 mm |
| type | cylindrical |
| material (sensing device) | glass (borosilicate) |
| housing material | stainless steel DIN 1.4305/AISI 303 |
| connection types | 3 pin cable |

ambient conditions

| | |
|-----------------------|--------------|
| operating temperature | 0 ... +65 °C |
| protection class | IP 67 |

order reference

FFAM 16PTD1002/L

dimension drawing

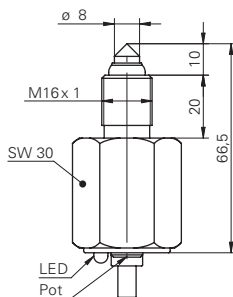

connection diagram

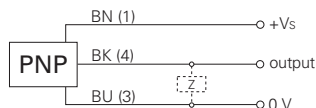

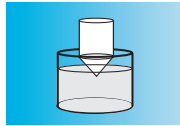

- Liquid level sensor for pipe mounting
- pipe diameter from 8 ... 13mm
- easy setup - no adjustment necessary



general data

| | |
|--|-----------------------|
| type | Liquid level sensor |
| light source | pulsed infrared diode |
| output indicator | LED red |
| sensitivity adjustment | no |
| wave length | 950 nm |
| max. outer diameter of the pipe / tube | 8 ... 13 mm |
| max. thickness of the pipe / tube | 1 mm |

electrical data

| | |
|------------------------------|---------------------------------|
| response time / release time | < 2 ms |
| voltage supply range +Vs | 9 ... 30,8 VDC |
| current consumption max. | 25 mA |
| voltage drop Vd | < 1 VDC |
| output function | light / dark operate switchable |
| output circuit | PNP |
| output current | < 100 mA |
| short circuit protection | yes |
| reverse polarity protection | yes |

mechanical data

| | |
|------------------|-------------|
| width / diameter | 16 mm |
| height / length | 28 mm |
| depth | 26 mm |
| type | rectangular |
| housing material | PC |
| connection types | cable 3 pin |

ambient conditions

| | |
|-----------------------|----------------|
| operating temperature | -10 ... +55 °C |
| protection class | IP 50 |

order reference

FFDK 16P50Y0

dimension drawing

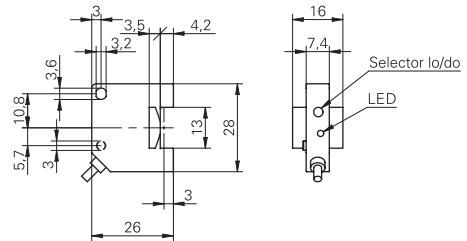

connection diagram

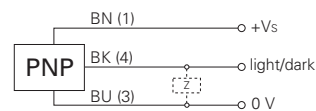

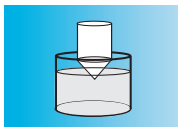

- leakage sensor with integrated electronics
- detects liquid amounts of approx. 1 ml
- chemical resistance thanks to Teflon PFA sheath

general data

| | |
|------------------------|----------------|
| type | Leakage sensor |
| light source | pulsed red LED |
| output indicator | LED orange |
| light indicator | LED green |
| sensitivity adjustment | no |
| wave length | 645 nm |

electrical data

| | |
|------------------------------|----------------------|
| response time / release time | < 1 ms |
| voltage supply range +Vs | 10,8 ... 26,4 VDC |
| current consumption max. | 30 mA |
| voltage drop Vd | < 1 VDC |
| output function | normally closed (NC) |
| output circuit | PNP |
| output current | < 50 mA |
| short circuit protection | yes |
| reverse polarity protection | yes |

mechanical data

| | |
|---------------------------|-------------|
| width / diameter | 23 mm |
| height / length | 10,5 mm |
| depth | 37,2 mm |
| type | rectangular |
| material (sensing device) | teflon PFA |
| housing material | Teflon PFA |
| connection types | cable 3 pin |

ambient conditions

| | |
|-----------------------|----------------|
| operating temperature | -25 ... +50 °C |
| protection class | IP 67 |

order reference

FODK 23P90Y0

dimension drawing

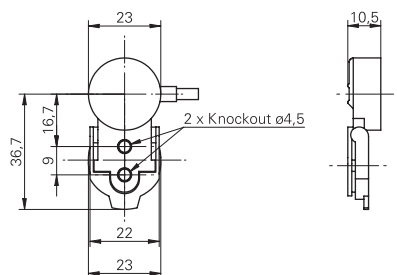

connection diagram

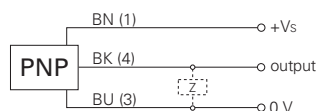

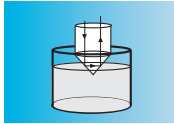

Fiber optic level sensor FUL

- the special sensor tip prevents drop formation
- high chemical resistance

| general data | |
|------------------------|---|
| type | liquid level sensor |
| optical fiber length | 2 m |
| mechanical data | |
| type | cylindrical |
| min. bending radius | 30 mm |
| tensile strength | 5 N |
| optical fiber material | Teflon® PFA |
| ambient conditions | |
| operating temperature | -30 ... +105 °C |
| order reference | |
| FUL 200D2Y00 | (use with fiber optic sensor FVDK 67 / FVDK 69) |

dimension drawing

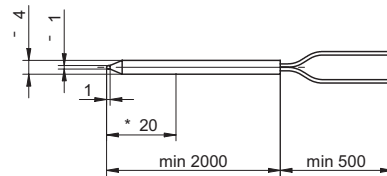

Fiber optic level sensor for stand pipe mounting FSL

- fine light curtain suppresses foam/air bubbles
- diameter of the pipe/tube 3 ... 13 mm

| general data | |
|--------------------------------------|---|
| type | liquid level sensor |
| optical fiber length | 5 m |
| max. outer diameter of the pipe/tube | 3 ... 13 mm |
| max. thickness of the pipe/tube | 1 mm |
| mechanical data | |
| type | rectangular |
| min. bending radius | 4 mm |
| tensile strength | 20 N |
| optical fiber material | PMMA, PFA coated |
| housing material | PEI / PC |
| ambient conditions | |
| operating temperature | -30 ... +70 °C |
| order reference | |
| FSL 500C6Y00 | (use with fiber optic sensor FVDK 67 / FVDK 69) |

dimension drawing

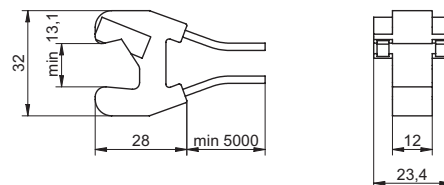

Fiber optic leak sensor FOC

- detects typical liquid volumes of 1 ml
- high chemical resistance

| general data | |
|------------------------|---|
| type | leakage sensor |
| optical fiber length | 5 m |
| mechanical data | |
| type | rectangular |
| min. bending radius | 20 mm |
| tensile strength | 10 N |
| optical fiber material | PE, PFA coated |
| housing material | Teflon® PFA |
| ambient conditions | |
| operating temperature | -30 ... +70 °C |
| order reference | |
| FOC 500C6Y00 | (use with fiber optic sensor FVDK 67 / FVDK 69) |

dimension drawing

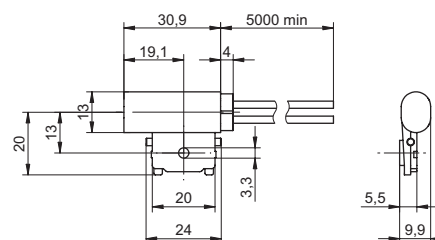

Light barriers

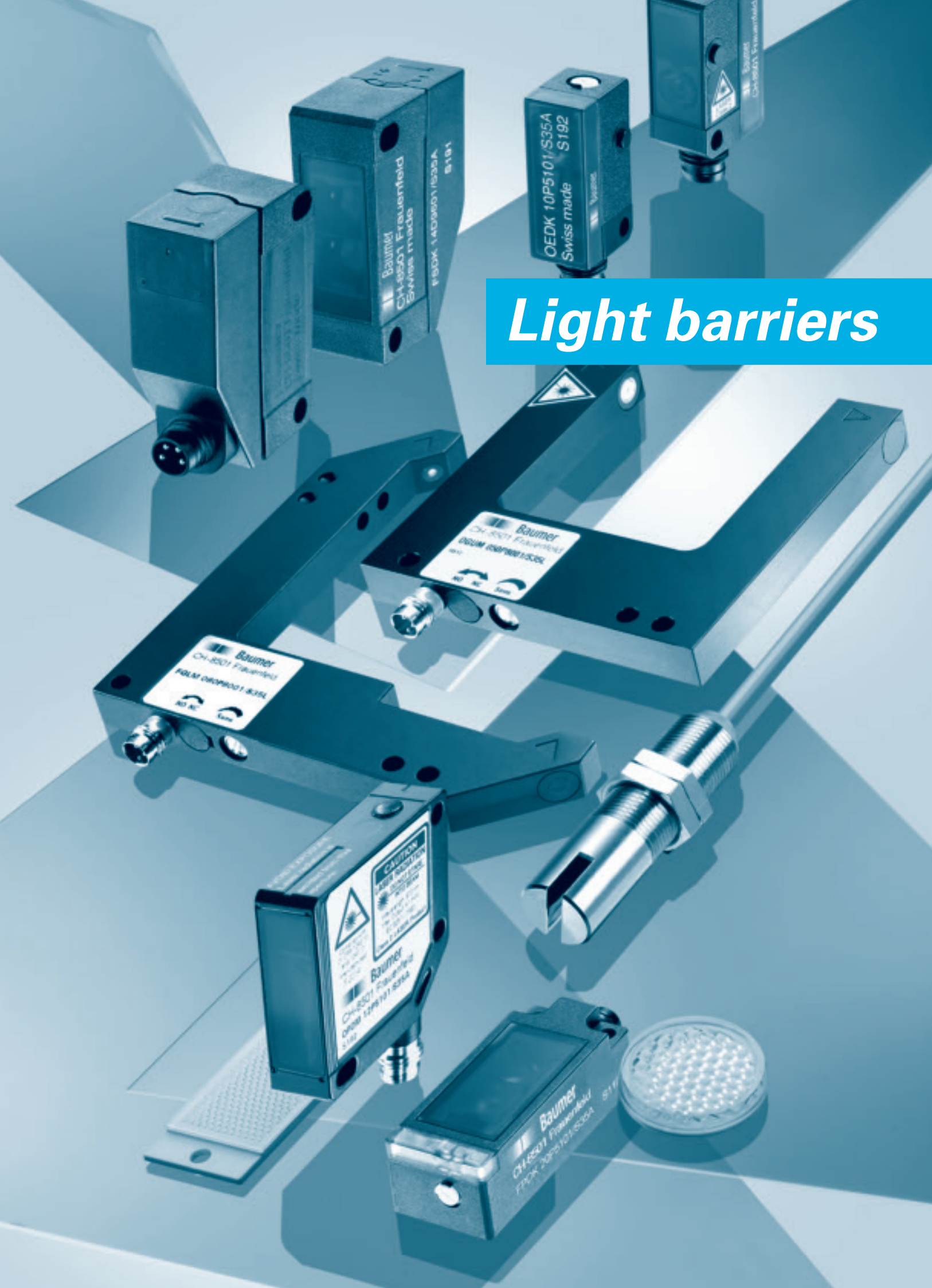

red light LED version

| product family | FPCCK 07 | FPDK 07 | FPDK 10 | FPDM 12 | FPDK 14 | FRDK 14 | FPDM 16 |
|------------------------------|---|---|---|---|---|---|---|
| |  |  |  |  |  |  |  |
| | | | | | | IO-Link | |
| for transparent objects | | | | | | ■ | |
| version | | | | | single lens optics | | |
| width / diameter | 8 mm | 8 mm | 10,4 mm | 12,4 mm | 14,8 mm | 14,8 mm | 15,4 mm |
| actual range Sb | 0,5 m | 0,5 m | 1,8 m | 5,1 m | 4 m 7,2 m | 1 m | 7,3 m |
| response time / release time | < 0,5 ms | < 0,5 ms | < 1 ms | < 1 ms | < 1 ms | < 0,1 ms | < 1 ms |
| sensitivity adjustment | Teach-in | Teach-in | no | no Pot, 5 turn | no | Teach-in | no Pot, 10 turn |
| NPN | ■ | ■ | ■ | ■ | ■ | ■ | ■ |
| PNP | ■ | ■ | ■ | ■ | ■ | ■ | ■ |
| cable | ■ | ■ | ■ | ■ | | | ■ |
| connector | ■ | ■ | ■ | ■ | ■ | ■ | ■ |
| housing material | plastic | plastic | plastic | metal | plastic | plastic | metal |
| Page | 358 | 360 | 362 | 364 | 368 | 370 | 376 |

laser version

| product family | OPDM 12 | OPDK 14 | OPDK 14 | OPDM 16 |
|------------------------------|---|---|---|---|
| |  |  |  |  |
| for transparent objects | | | ■ | |
| version | single lens optics | single lens optics | single lens optics | |
| width / diameter | 12,4 mm | 14,8 mm | 14,8 mm | 15,4 mm |
| actual range Sb | 1 m 5 m 11 m | 10 m | 1 m | 1 m 11 m |
| response time / release time | < 0,05 ms < 0,1 ms | < 0,25 ms | < 0,25 ms | < 0,1 ms |
| sensitivity adjustment | no | Teach-in | Teach-in | no Pot, 270° |
| NPN | ■ | ■ | | |
| PNP | ■ | ■ | ■ | ■ |
| cable | ■ | | | ■ |
| connector | ■ | ■ | ■ | ■ |
| housing material | metal | plastic | plastic | metal |
| Page | 366 | 372 | 374 | 380 |

| FPDM 16 | FPAM 18 | FPDK 20 | FPDK 26 |
|---|---|---|---|
|  |  |  |  |
| ■ | | | |
| 15,4 mm | 18 mm | 20 mm | 25 mm |
| 4 m | 3,2 m | 4,5 m | 10 m |
| < 2,5 ms | < 1 ms | < 0,5 ms | < 1 ms |
| Teach-in | no | Pot, 270° | Pot, 270° |
| ■ | ■ | ■ | ■ |
| ■ | ■ | ■ | ■ |
| metal | metal | plastic | plastic |
| | | | |
| 378 | 382 | 384 | 386 |



General information

The emitter and receiver are installed in the same housing. The emitted infrared, red or laser light is returned by a triple reflector or a reflective film to the receiver. The output changes its state when the object breaks the light beam (sensor receives no light).

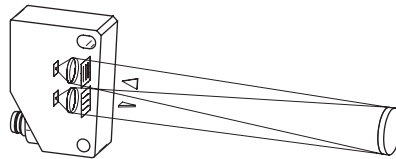

Applications

- Stack height monitoring
- Detection of objects located at any position on a conveyor belt
- Detection of transparent objects
- Detection of glossy objects on a conveyor belt
- Retro-reflective laser sensors with single-lens optics permit the precise detection of objects through small openings and the smallest distances between the sensor and the reflector.

Characteristics and advantages

Polarizing filter

Permits objects to be detected regardless of the texture and color of the surface. Glossy and reflective objects are also reliably detected.

Single-lens optics

The emitted and received beams are on the same axis. The direction of approach of the object is thereby irrelevant and it is possible to view through small openings. Reflectors can also be used in close proximity without a loss of the signal.

Transparent objects

Special versions of retro-reflective sensors can also detect transparent objects such as packaging films, PET bottles and glassware.

Short response times

Retro-reflective laser sensors with response times of 0,05 ms and focused laser beams correctly detect the smallest, quickly-moving objects (0,1 mm diameter).

Technology and operation

The polarizing filter permits the emitted light to pass in only one polarization plane. The triple reflector depolarizes the light on reflection. A part of the light reflected back to the receiver passes the second polarization filter, offset by 90°, and is detected by the receiver.

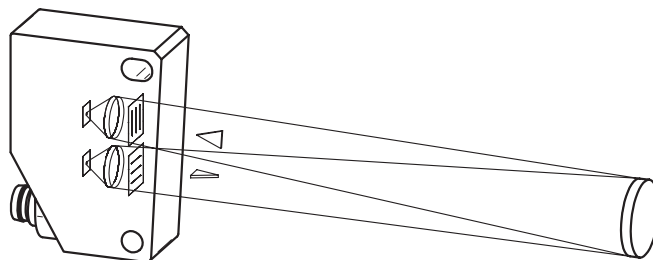

Retro-reflective sensors



Technology and operation

A glossy object in the light beam reflects the light without changing its polarization plane. This light cannot pass through the polarization filter in front of the receiver. A glossy object therefore also breaks the light beam.

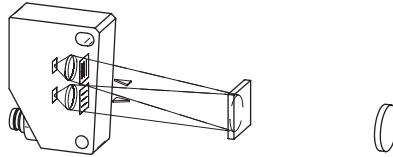

Mounting and adjustment

Each sensor has a separate excess gain curve. As the operating reliability depends heavily on the ambient conditions, it must be ensured that the sensor operates with the highest possible excess signal gain.

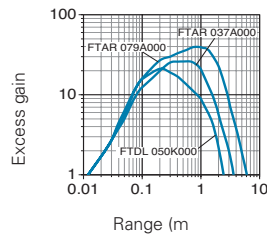

With narrow light beams as used in laser sensors, the size of the light spot on the reflector in relation to the triple structure is important for the choice of the reflector or the reflective film. A spot diameter of up to 1,5 mm, a reflective film should be used, and up to a spot diameter of 3 mm, reflectors with microstructures. It should also be ensured that the reflective film or reflector is not placed close to the focus.

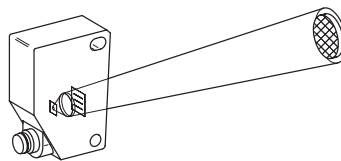

The reflector is aligned and centered.

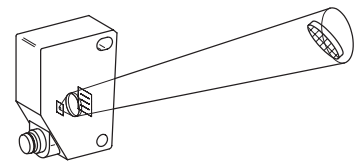

The reflector may not be tilted by more than 15°.

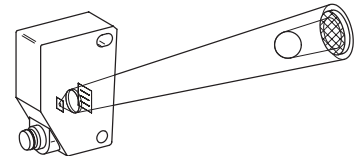
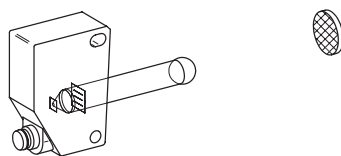

For a correct function, the object must cover the reflector or at least have the size of the beam diameter.

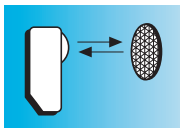

S_b = 0,5 m



- ultra compact housing
- sensing distance adjustable via Teach-in
- suppression of mutual optical interference

general data

| | |
|-------------------------------------|--------------------------|
| type | retro-reflective sensor |
| light source | pulsed red LED |
| actual range S _b | 0,5 m |
| nominal range S _n | 0,6 m |
| polarization filter | yes |
| alignment / soiled lens indicator | flashing light indicator |
| light indicator | LED green |
| output indicator | LED yellow |
| sensitivity adjustment | Teach-in |
| wave length | 660 nm |
| suppression of reciprocal influence | yes |

electrical data

| | |
|------------------------------|----------------------|
| response time / release time | < 0,5 ms |
| voltage supply range +Vs | 10 ... 30 VDC |
| current consumption max. | 25 mA |
| current consumption typ. | 20 mA |
| voltage drop V _d | < 1,8 VDC |
| output function | light / dark operate |
| output current | < 100 mA |
| short circuit protection | yes |
| reverse polarity protection | yes |

mechanical data

| | |
|------------------|--------------------------|
| width / diameter | 8 mm |
| height / length | 17,8 mm |
| depth | 12,6 mm |
| type | rectangular |
| housing material | plastic (PMMA, MABS, PA) |
| front (optics) | PMMA |

ambient conditions

| | |
|-----------------------|----------------|
| operating temperature | -20 ... +50 °C |
| protection class | IP 65 |

connection diagrams

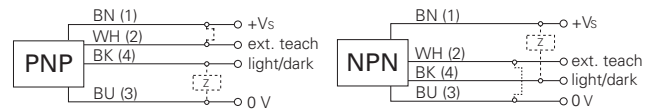

connectors

| | | |
|--------------|-------|--------------|
| ESG 32AH0200 | 4 pin | 2 m straight |
| ESW 31AH0200 | 4 pin | 2 m angular |

additional cable connectors and field wireable connectors, see accessories

accessories

| | |
|----------------------|--------|
| MINOFIX mounting kit | 150844 |
|----------------------|--------|

for details, see accessories section

order reference connection types output circuit

| | | |
|---------------------------|-----------------------------|-----|
| FPCK 07N6901 | cable rear side | NPN |
| FPCK 07N6901/KS35A | flylead connector M8, 4 pin | NPN |
| FPCK 07P6901 | cable rear side | PNP |
| FPCK 07P6901/KS35A | flylead connector M8, 4 pin | PNP |

FPCK 07 S_b = 0,5 m

Retro-reflective sensors

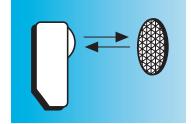

excess gain curve

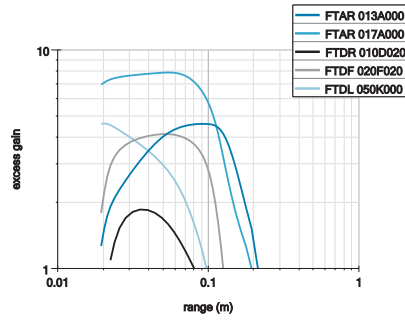
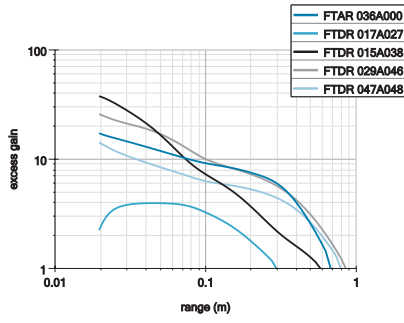

reflectors

| | |
|--------------------|--------------------|
| FTAR 013A000 | ∅ 15 mm |
| FTAR 017A000 | ∅ 20,7 mm |
| FTAR 020A000 | ∅ 25,2 mm |
| FTAR 036A000 | ∅ 46 mm |
| FTDF 020F020 | tape 20 x 20 mm |
| FTDL 050K000/... m | tape 50 mm x ... m |
| FTDR 010D020 | 15 x 25 mm |
| FTDR 015A038 | 18 x 40 mm |
| FTDR 017A027 | 20 x 42 mm |
| FTDR 029A046 | 32,5 x 48 mm |
| FTDR 047A048 | 54 x 75 mm |

dimension drawings

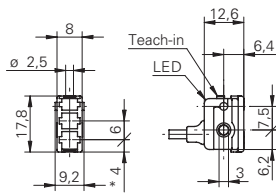

* emitter axis

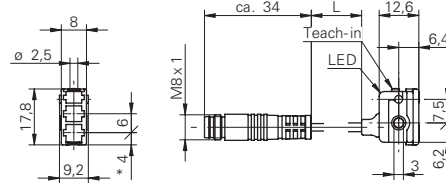

* emitter axis cable length L = 200 mm

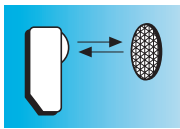

S_b = 0,5 m

- ultra compact housing
- sensing distance adjustable via Teach-in
- suppression of mutual optical interference



general data

| | |
|-------------------------------------|--------------------------|
| type | retro-reflective sensor |
| light source | pulsed red LED |
| actual range S _b | 0,5 m |
| nominal range S _n | 0,6 m |
| polarization filter | yes |
| alignment / soiled lens indicator | flashing light indicator |
| light indicator | LED green |
| output indicator | LED yellow |
| sensitivity adjustment | Teach-in |
| wave length | 660 nm |
| suppression of reciprocal influence | yes |

electrical data

| | |
|------------------------------|----------------------|
| response time / release time | < 0,5 ms |
| voltage supply range +Vs | 10 ... 30 VDC |
| current consumption max. | 25 mA |
| current consumption typ. | 20 mA |
| voltage drop V _d | < 1,8 VDC |
| output function | light / dark operate |
| output current | < 100 mA |
| short circuit protection | yes |
| reverse polarity protection | yes |

mechanical data

| | |
|------------------|--------------------------|
| width / diameter | 8 mm |
| height / length | 17,8 mm |
| depth | 12,6 mm |
| type | rectangular |
| housing material | plastic (PMMA, MABS, PA) |
| front (optics) | PMMA |

ambient conditions

| | |
|-----------------------|----------------|
| operating temperature | -20 ... +50 °C |
| protection class | IP 65 |

connection diagrams

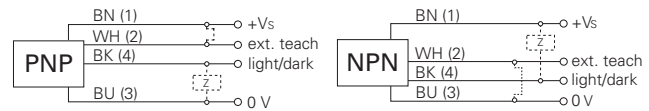

connectors

| | | |
|--------------|-------|--------------|
| ESG 32AH0200 | 4 pin | 2 m straight |
| ESW 31AH0200 | 4 pin | 2 m angular |

additional cable connectors and field wireable connectors, see accessories

accessories

| | |
|----------------------|--------|
| MINOFIX mounting kit | 150844 |
|----------------------|--------|

for details, see accessories section

| order reference | connection types | output circuit |
|--------------------|-----------------------------|----------------|
| FPDK 07N6901 | cable bottom side | NPN |
| FPDK 07N6901/KS35A | flylead connector M8, 4 pin | NPN |
| FPDK 07P6901 | cable bottom side | PNP |
| FPDK 07P6901/KS35A | flylead connector M8, 4 pin | PNP |

FPDK 07 S_b = 0,5 m

Retro-reflective sensors

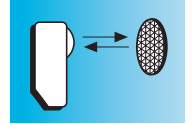

excess gain curve

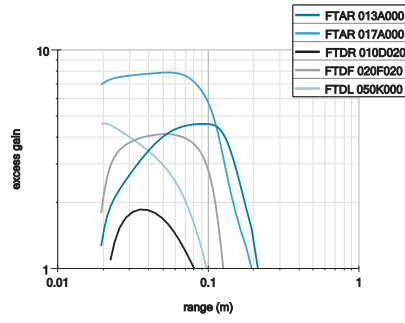
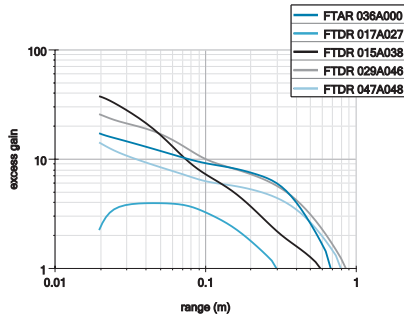

reflectors

| | |
|--------------------|--------------------|
| FTAR 013A000 | ø 15 mm |
| FTAR 017A000 | ø 20,7 mm |
| FTAR 020A000 | ø 25,2 mm |
| FTAR 036A000 | ø 46 mm |
| FTDF 020F020 | tape 20 x 20 mm |
| FTDL 050K000/... m | tape 50 mm x ... m |
| FTDR 010D020 | 15 x 25 mm |
| FTDR 015A038 | 18 x 40 mm |
| FTDR 017A027 | 20 x 42 mm |
| FTDR 029A046 | 32,5 x 48 mm |
| FTDR 047A048 | 54 x 75 mm |

dimension drawings

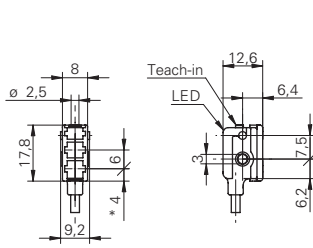

* emitter axis

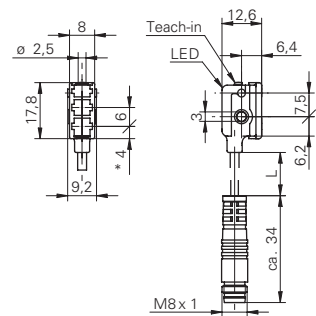

* emitter axis cable length L = 200 mm

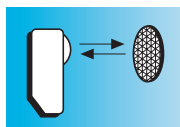

S_b = 1,8 m

- subminiature housing
- polarization filter to detect shiny objects
- suppression of mutual optical interference



general data

| | |
|-------------------------------------|--------------------------|
| type | retro-reflective sensor |
| light source | pulsed red LED |
| actual range S _b | 1,8 m |
| nominal range S _n | 2,2 m |
| polarization filter | yes |
| alignment / soiled lens indicator | flashing light indicator |
| light indicator | LED yellow |
| sensitivity adjustment | no |
| wave length | 660 nm |
| suppression of reciprocal influence | yes |

electrical data

| | |
|------------------------------|---------------|
| response time / release time | < 1 ms |
| voltage supply range +Vs | 10 ... 30 VDC |
| current consumption max. | 30 mA |
| current consumption typ. | 20 mA |
| voltage drop V _d | < 1,8 VDC |
| output current | < 100 mA |
| short circuit protection | yes |
| reverse polarity protection | yes |

mechanical data

| | |
|------------------|---------------|
| width / diameter | 10,4 mm |
| height / length | 27 mm |
| depth | 14 mm |
| type | rectangular |
| housing material | plastic (ASA) |
| front (optics) | PMMA |

ambient conditions

| | |
|-----------------------|----------------|
| operating temperature | -25 ... +65 °C |
|-----------------------|----------------|

connection diagrams

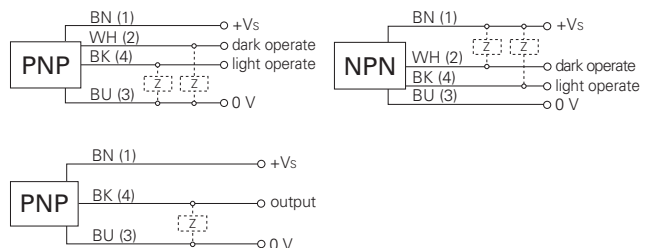

connectors

| | | |
|--------------|-------|--------------|
| ESG 32SH0200 | 3 pin | 2 m straight |
| ESW 31SH0200 | 3 pin | 2 m angular |
| ESG 32AH0200 | 4 pin | 2 m straight |
| ESW 31AH0200 | 4 pin | 2 m angular |

additional cable connectors and field wireable connectors, see accessories

accessories

| | |
|-----------------------------------|--------|
| SENSOFIX mounting kit | 150326 |
| mounting bracket (cable type) | 114501 |
| mounting bracket (connector type) | 133792 |

for details, see accessories section

| order reference | connection types | output circuit | output function | protection class |
|-------------------|-----------------------------|----------------|----------------------|------------------|
| FPDK 10N5101 | cable 4 pin | NPN | light / dark operate | IP 65 |
| FPDK 10N5101/S35A | connector M8, 4 pin | NPN | light / dark operate | IP 67 |
| FPDK 10P3101/KS35 | flylead connector M8, 3 pin | PNP | dark operate | IP 65 |
| FPDK 10P5101 | cable 4 pin | PNP | light / dark operate | IP 65 |
| FPDK 10P5101/S35A | connector M8, 4 pin | PNP | light / dark operate | IP 67 |

FPDK 10 S_b = 1,8 m

Retro-reflective sensors

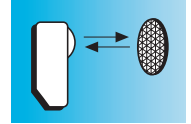

excess gain curve

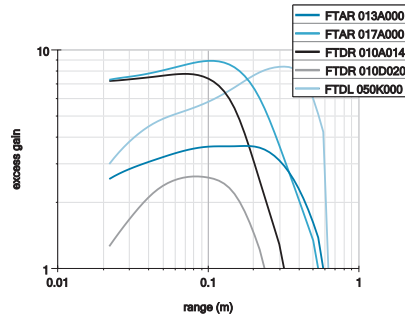
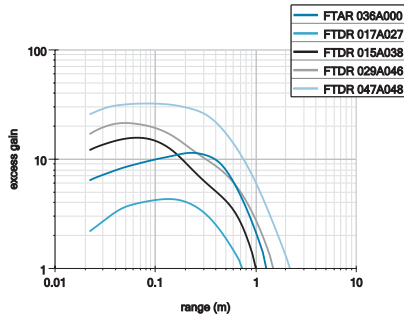

reflectors

| | |
|--------------------|------------------|
| FTAR 013A000 | ø 15 mm |
| FTAR 017A000 | ø 20,7 mm |
| FTAR 020A000 | ø 25,2 mm |
| FTAR 036A000 | ø 46 mm |
| FTDL 050K000/... m | tape 50 x ... mm |
| FTDR 010A014 | 12,8 x 16,8 mm |
| FTDR 010D020 | 15 x 25 mm |
| FTDR 015A038 | 18 x 40 mm |
| FTDR 017A027 | 20 x 42 mm |
| FTDR 029A046 | 32,5 x 48 mm |
| FTDR 047A048 | 54 x 75 mm |

dimension drawings

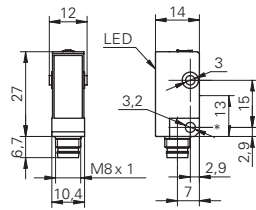

* emitter axis

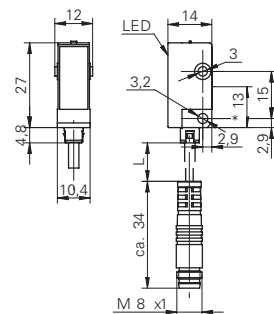

* emitter axis cable length L = 200 mm

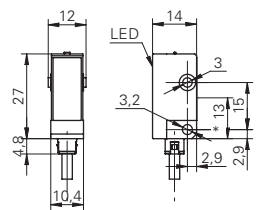

* emitter axis

FDPK 10 Sb = 1,8 m

Retro-reflective sensors

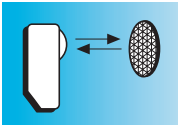

S_b = 5,1 m

- rugged miniature metal housing
- polarization filter to detect shiny objects
- available with alarm output



general data

| | |
|-----------------------------------|--------------------------|
| type | retro-reflective sensor |
| light source | pulsed red LED |
| actual range S _b | 5,1 m |
| nominal range S _n | 5,5 m |
| polarization filter | yes |
| alignment / soiled lens indicator | flashing light indicator |
| light indicator | LED yellow |
| wave length | 660 nm |

electrical data

| | |
|------------------------------|---------------|
| response time / release time | < 1 ms |
| voltage supply range +Vs | 10 ... 30 VDC |
| current consumption max. | 35 mA |
| current consumption typ. | 25 mA |
| voltage drop V _d | < 1,8 VDC |
| output current | < 100 mA |
| short circuit protection | yes |
| reverse polarity protection | yes |

mechanical data

| | |
|------------------|---------------|
| width / diameter | 12,4 mm |
| height / length | 35 mm |
| depth | 35 mm |
| type | rectangular |
| housing material | die-cast zinc |
| front (optics) | PMMA |

ambient conditions

| | |
|-----------------------|----------------|
| operating temperature | -25 ... +65 °C |
| protection class | IP 67 |

connection diagrams

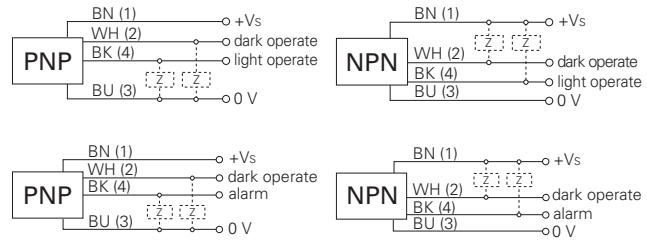

connectors

| | | |
|--------------|-------|--------------|
| ESG 32AH0200 | 4 pin | 2 m straight |
| ESW 31AH0200 | 4 pin | 2 m angular |

additional cable connectors and field wireable connectors, see accessories

accessories

| | |
|-----------------------|--------|
| SENSOFIX mounting kit | 150328 |
| mounting bracket | 113873 |

for details, see accessories section

| order reference | connection types | output circuit | output function | sensitivity adjustment | suppression of reciprocal influence |
|-------------------|---------------------|----------------|----------------------|------------------------|-------------------------------------|
| FPDM 12N3401 | cable 4 pin | NPN | alarm output dark | no | yes |
| FPDM 12N3401/S35A | connector M8, 4 pin | NPN | alarm output dark | no | yes |
| FPDM 12N5101 | cable 4 pin | NPN | light / dark operate | no | yes |
| FPDM 12N5101/S35A | connector M8, 4 pin | NPN | light / dark operate | no | yes |
| FPDM 12P3401 | cable 4 pin | PNP | alarm output dark | no | yes |
| FPDM 12P3401/S35A | connector M8, 4 pin | PNP | alarm output dark | no | yes |
| FPDM 12P5101 | cable 4 pin | PNP | light / dark operate | no | yes |
| FPDM 12P5101/S35A | connector M8, 4 pin | PNP | light / dark operate | no | yes |
| FPDM 12P5105/S35A | connector M8, 4 pin | PNP | light / dark operate | Pot, 5 turn | - |

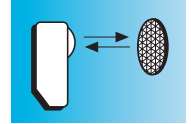

excess gain curve

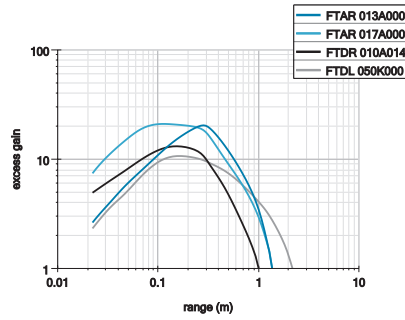
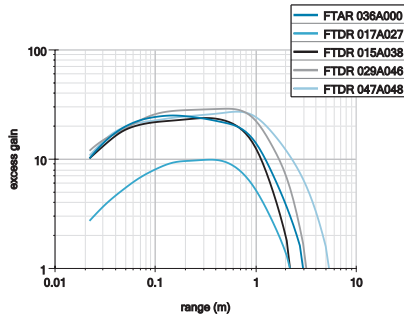

reflectors

| | |
|--------------------|------------------|
| FTAR 013A000 | ø 15 mm |
| FTAR 017A000 | ø 20,7 mm |
| FTAR 020A000 | ø 25,2 mm |
| FTAR 036A000 | ø 46 mm |
| FTDL 050K000/... m | tape 50 x ... mm |
| FTDR 010A014 | 12,8 x 16,8 mm |
| FTDR 015A038 | 18 x 40 mm |
| FTDR 017A027 | 20 x 42 mm |
| FTDR 029A046 | 32,5 x 48 mm |
| FTDR 047A048 | 54 x 75 mm |

dimension drawings

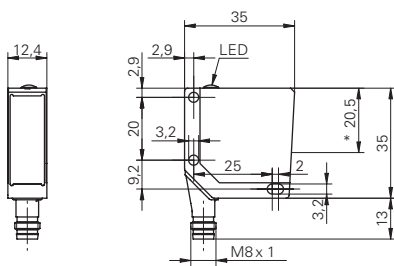

* emitter axis

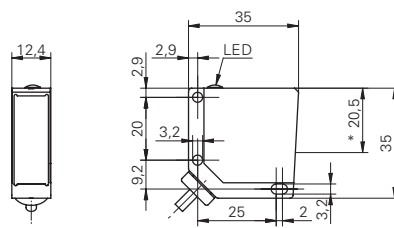

* emitter axis

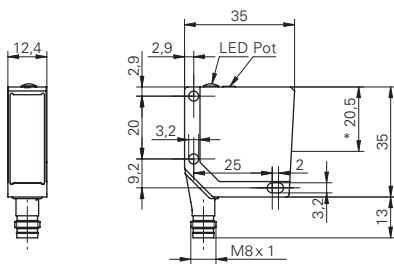

* emitter axis

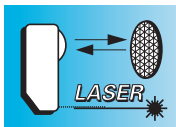

Sb = 11 m

- rugged miniature metal housing
- single lens optics
- short response time



general data

| | |
|-----------------------------------|-------------------------------|
| type | retro-reflective laser sensor |
| version | single lens optics |
| light source | pulsed red laser diode |
| repeatability | < 0,1 mm at laser focus |
| polarization filter | yes |
| alignment / soiled lens indicator | flashing light indicator |
| light indicator | LED yellow |
| power on indication | LED green |
| sensitivity adjustment | no |
| laser class | 2 |
| wave length | 675 nm |

| | |
|-------------------------------|---------------|
| actual range Sb = 1 m | |
| nominal range Sn | 1,2 m |
| distance to laser focus | 100 mm |
| actual range Sb = 5 m | |
| nominal range Sn | 5,5 m |
| distance to laser focus | 400 mm |
| actual range Sb = 11 m | |
| nominal range Sn | 13 m |
| distance to laser focus | parallel beam |

electrical data

| | |
|-----------------------------|----------------------|
| voltage supply range +Vs | 10 ... 30 VDC |
| current consumption max. | 50 mA |
| current consumption typ. | 40 mA |
| voltage drop Vd | < 1,8 VDC |
| output function | light / dark operate |
| output current | < 100 mA |
| short circuit protection | yes |
| reverse polarity protection | yes |

mechanical data

| | |
|------------------|---------------|
| width / diameter | 12,4 mm |
| height / length | 35 mm |
| depth | 35 mm |
| type | rectangular |
| housing material | die-cast zinc |
| front (optics) | glass |

ambient conditions

| | |
|-----------------------|----------------|
| operating temperature | -10 ... +50 °C |
| protection class | IP 67 |

connection diagrams



connectors

| | | |
|--------------|-------|--------------|
| ESG 32AH0200 | 4 pin | 2 m straight |
| ESW 31AH0200 | 4 pin | 2 m angular |

additional cable connectors and field wireable connectors, see accessories

accessories

| | |
|-----------------------|--------|
| SENSOFIX mounting kit | 150328 |
| mounting bracket | 113873 |

for details, see accessories section

laser warning

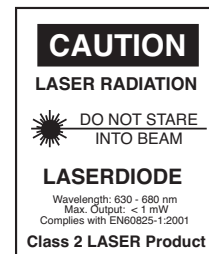

| order reference | actual range Sb | connection types | output circuit | response time / release time |
|-------------------|-----------------|---------------------|----------------|------------------------------|
| OPDM 12N5101 | 5 m | cable 4 pin | NPN | < 0,1 ms |
| OPDM 12N5101/S35A | 5 m | connector M8, 4 pin | NPN | < 0,1 ms |
| OPDM 12P5101 | 5 m | cable 4 pin | PNP | < 0,1 ms |
| OPDM 12P5101/S35A | 5 m | connector M8, 4 pin | PNP | < 0,1 ms |
| OPDM 12P5102/S35A | 1 m | connector M8, 4 pin | PNP | < 0,1 ms |
| OPDM 12P5103/S35A | 11 m | connector M8, 4 pin | PNP | < 0,1 ms |
| OPDM 12P5104/S35A | 1 m | connector M8, 4 pin | PNP | < 0,05 ms |

OPDM 12 Sb = 11 m Retro-reflective sensors

excess gain curve

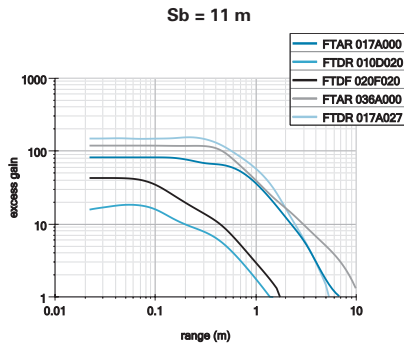
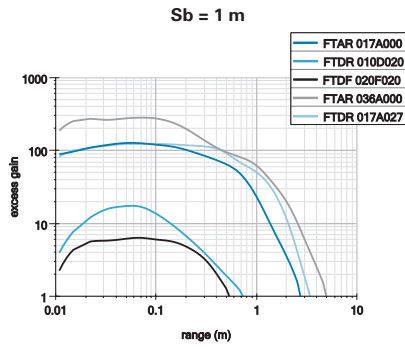
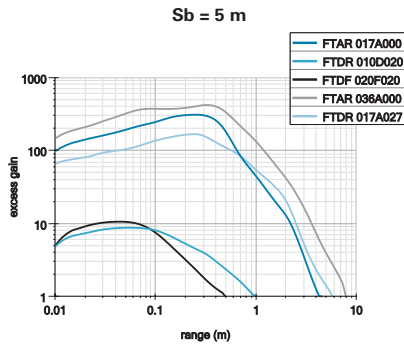

reflectors

| | |
|--------------|-----------------|
| FTAR 013A000 | ø 15 mm |
| FTAR 017A000 | ø 20,7 mm |
| FTAR 020A000 | ø 25,2 mm |
| FTAR 036A000 | ø 46 mm |
| FTDF 020F020 | tape 20 x 20 mm |
| FTDR 010D020 | 15 x 25 mm |
| FTDR 015A038 | 18 x 40 mm |
| FTDR 017A027 | 20 x 42 mm |
| FTDR 029A046 | 32,5 x 48 mm |
| FTDR 047A048 | 54 x 75 mm |

beam characteristic

Sb = 5 m

Sb = 1 m

Sb = 11 m

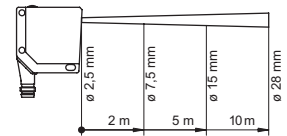
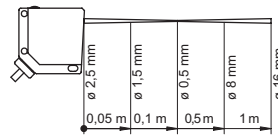
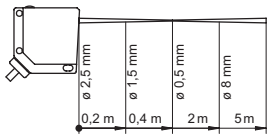

dimension drawings

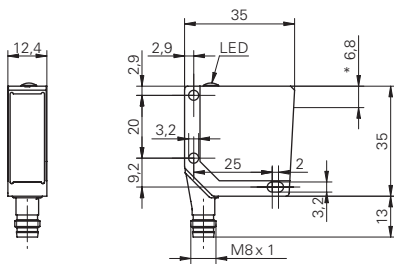

* emitter and receiver axis

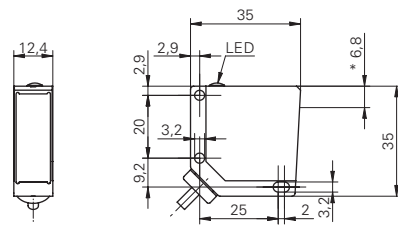

* emitter and receiver axis

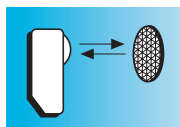

$S_b = 7,2 \text{ m}$

- polarization filter to detect shiny objects
- single lens optics
- suppression of mutual optical interference



general data

| | |
|-------------------------------------|--------------------------|
| type | retro-reflective sensor |
| light source | pulsed red LED |
| polarization filter | yes |
| alignment / soiled lens indicator | flashing light indicator |
| light indicator | LED yellow |
| sensitivity adjustment | no |
| wave length | 660 nm |
| suppression of reciprocal influence | yes |

actual range $S_b = 4 \text{ m}$

| | |
|---------------------|--------------------|
| version | single lens optics |
| nominal range S_n | 4,5 m |

actual range $S_b = 7,2 \text{ m}$

| | |
|---------------------|-----|
| nominal range S_n | 8 m |
|---------------------|-----|

electrical data

| | |
|------------------------------|----------------------|
| response time / release time | < 1 ms |
| voltage supply range +Vs | 10 ... 30 VDC |
| current consumption max. | 25 mA |
| current consumption typ. | 20 mA |
| voltage drop Vd | < 1,8 VDC |
| output function | light / dark operate |
| output current | < 100 mA |
| short circuit protection | yes |
| reverse polarity protection | yes |

mechanical data

| | |
|------------------|---------------------|
| width / diameter | 14,8 mm |
| height / length | 43 mm |
| depth | 31 mm |
| type | rectangular |
| housing material | plastic (PA12) |
| front (optics) | PMMA |
| connection types | connector M8, 4 pin |

ambient conditions

| | |
|-----------------------|----------------|
| operating temperature | -25 ... +65 °C |
| protection class | IP 67 |

connection diagrams



connectors

| | | |
|--------------|-------|--------------|
| ESG 32AH0200 | 4 pin | 2 m straight |
| ESW 31AH0200 | 4 pin | 2 m angular |

additional cable connectors and field wireable connectors, see accessories

accessories

| | |
|-----------------------|--------|
| SENSOFIX mounting kit | 149011 |
| mounting bracket | 134964 |

for details, see accessories section

| order reference | actual range S_b | output circuit |
|-------------------|--------------------|----------------|
| FPDK 14N5101/S35A | 7,2 m | NPN |
| FPDK 14N5111/S35A | 4 m | NPN |
| FPDK 14P5101/S35A | 7,2 m | PNP |
| FPDK 14P5111/S35A | 4 m | PNP |

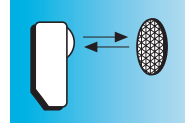

excess gain curve

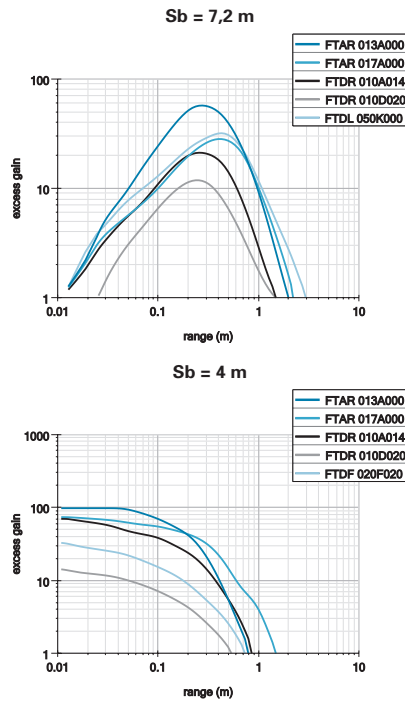
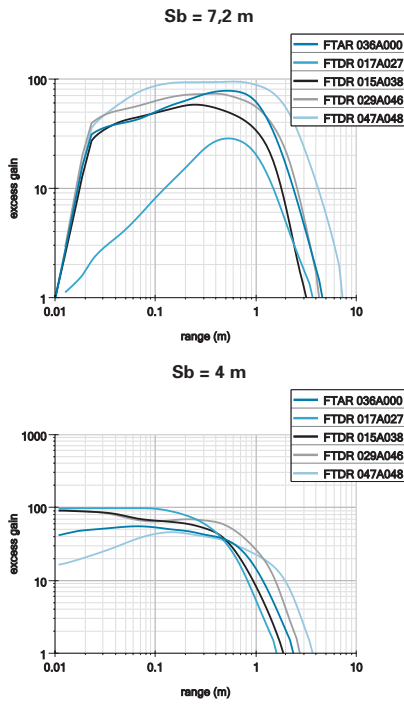

reflectors

| | |
|--------------------|------------------|
| FTAR 013A000 | ø 15 mm |
| FTAR 017A000 | ø 20,7 mm |
| FTAR 020A000 | ø 25,2 mm |
| FTAR 036A000 | ø 46 mm |
| FTDF 020F020 | tape 20 x 20 mm |
| FTDL 050K000/... m | tape 50 x ... mm |
| FTDR 010A014 | 12,8 x 16,8 mm |
| FTDR 010D020 | 15 x 25 mm |
| FTDR 015A038 | 18 x 40 mm |
| FTDR 017A027 | 20 x 42 mm |
| FTDR 029A046 | 32,5 x 48 mm |
| FTDR 047A048 | 54 x 75 mm |

dimension drawings

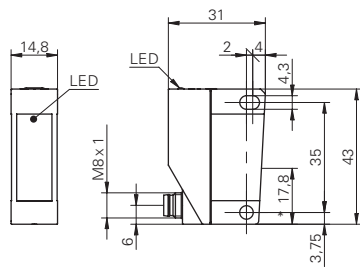

* emitter axis

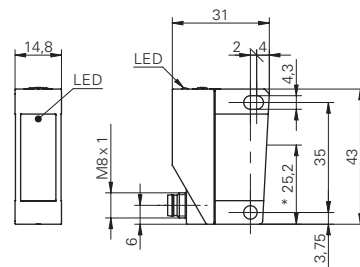

* emitter and receiver axis

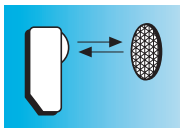

S_b = 1 m



- designed for detection of transparent objects
- sensitivity adjustable via Teach-in
- short response time



general data

| | |
|------------------------------|-------------------------|
| type | retro-reflective sensor |
| special type | for transparent objects |
| light source | pulsed red LED |
| actual range S _b | 1 m |
| nominal range S _n | 1,5 m |
| polarization filter | no |
| light indicator | LED yellow |
| sensitivity adjustment | Teach-in |
| wave length | 660 nm |

electrical data

| | |
|------------------------------|---------------|
| response time / release time | < 0,1 ms |
| Teach-in signal time | > 500 µs |
| adaption time | < 20 ms |
| voltage supply range +Vs | 10 ... 30 VDC |
| current consumption max. | 40 mA |
| current consumption typ. | 35 mA |
| voltage drop V _d | < 2,2 VDC |
| output current | < 100 mA |
| short circuit protection | yes |
| reverse polarity protection | yes |

mechanical data

| | |
|------------------|---------------------|
| width / diameter | 14,8 mm |
| height / length | 43 mm |
| depth | 31 mm |
| type | rectangular |
| housing material | plastic (PA12) |
| front (optics) | PA |
| connection types | connector M8, 4 pin |

ambient conditions

| | |
|-----------------------|----------------|
| operating temperature | -25 ... +65 °C |
| protection class | IP 67 |

connection diagrams

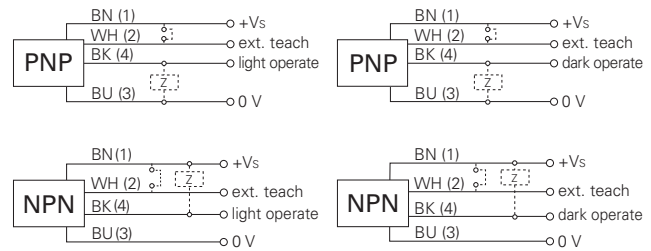

connectors

| | | |
|--------------|-------|--------------|
| ESG 32AH0200 | 4 pin | 2 m straight |
| ESW 31AH0200 | 4 pin | 2 m angular |

additional cable connectors and field wireable connectors, see accessories

accessories

| | |
|-----------------------|--------|
| SENSOFIX mounting kit | 149011 |
| mounting bracket | 134964 |

for details, see accessories section

| order reference | output circuit | output function | teach value stored after power-off |
|-------------------|----------------|-----------------|------------------------------------|
| FRDK 14N1902/S35A | NPN | light operate | volatile |
| FRDK 14N1903/S35A | NPN | light operate | non volatile |
| FRDK 14N3902/S35A | NPN | dark operate | volatile |
| FRDK 14N3903/S35A | NPN | dark operate | non volatile |
| FRDK 14P1902/S35A | PNP | light operate | volatile |
| FRDK 14P1903/S35A | PNP | light operate | non volatile |
| FRDK 14P3902/S35A | PNP | dark operate | volatile |
| FRDK 14P3903/S35A | PNP | dark operate | non volatile |

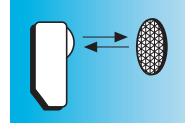

excess gain curve

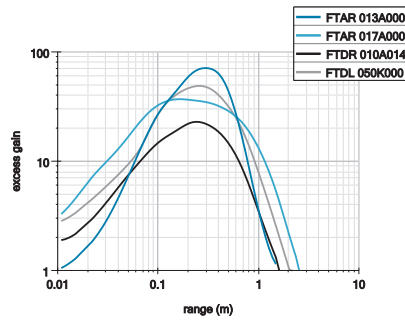
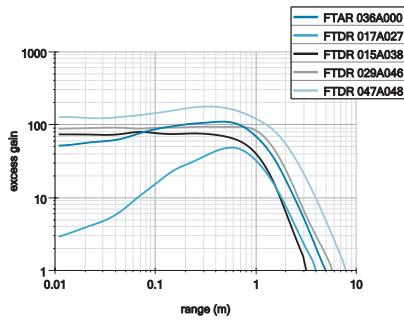

reflectors

| | |
|--------------------|------------------|
| FTAR 013A000 | ø 15 mm |
| FTAR 017A000 | ø 20,7 mm |
| FTAR 020A000 | ø 25,2 mm |
| FTAR 036A000 | ø 46 mm |
| FTDL 050K000/... m | tape 50 x ... mm |
| FTDR 010A014 | 12,8 x 16,8 mm |
| FTDR 015A038 | 18 x 40 mm |
| FTDR 017A027 | 20 x 42 mm |
| FTDR 029A046 | 32,5 x 48 mm |
| FTDR 047A048 | 54 x 75 mm |

dimension drawing

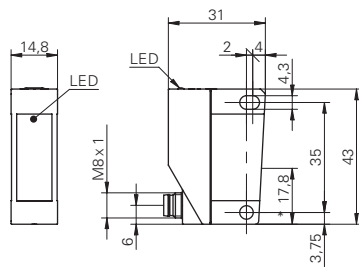

* emitter axis

FRDK 14 Sb = 1 m

Retro-reflective sensors

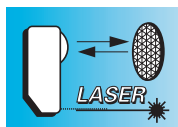

Sb = 10 m



- single lens optics
- long sensing range
- short response time

general data

| | |
|-----------------------------------|-------------------------------|
| type | retro-reflective laser sensor |
| version | single lens optics |
| light source | pulsed red laser diode |
| actual range Sb | 10 m |
| nominal range Sn | 11 m |
| repeatability | < 0,1 mm at laser focus |
| polarization filter | yes |
| alignment / soiled lens indicator | flashing light indicator |
| light indicator | LED yellow |
| power on indication | LED green |
| sensitivity adjustment | Teach-in |
| laser class | 1 |
| distance to laser focus | 400 mm |
| wave length | 650 nm |

electrical data

| | |
|------------------------------|---------------|
| response time / release time | < 0,25 ms |
| voltage supply range +Vs | 10 ... 30 VDC |
| current consumption max. | 35 mA |
| current consumption typ. | 25 mA |
| voltage drop Vd | < 2,2 VDC |
| output current | < 100 mA |
| short circuit protection | yes |
| reverse polarity protection | yes |

mechanical data

| | |
|------------------|---------------------|
| width / diameter | 14,8 mm |
| height / length | 43 mm |
| depth | 31 mm |
| type | rectangular |
| housing material | plastic (PA12) |
| front (optics) | PMMA |
| connection types | connector M8, 4 pin |

ambient conditions

| | |
|-----------------------|----------------|
| operating temperature | -10 ... +50 °C |
| protection class | IP 67 |

connection diagrams

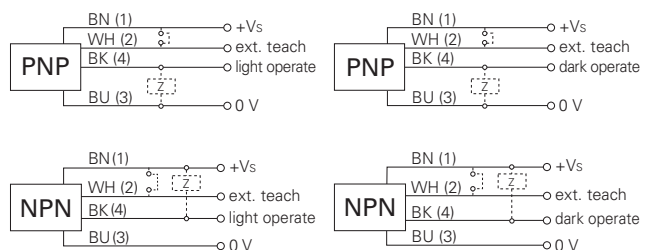

connectors

| | | |
|--------------|-------|--------------|
| ESG 32AH0200 | 4 pin | 2 m straight |
| ESW 31AH0200 | 4 pin | 2 m angular |

additional cable connectors and field wireable connectors, see accessories

accessories

| | |
|-----------------------|--------|
| SENSOFIX mounting kit | 149011 |
| mounting bracket | 134964 |

for details, see accessories section

laser warning

CLASS 1 LASER PRODUCT

Complies with 21 CFR 1040.10 and 1040.11
except for deviations pursuant to
Laser Notice No. 50, dated July 26, 2001

Complies with EN60825-1:2001

| order reference | output circuit | output function |
|-------------------|----------------|-----------------|
| OPDK 14N1901/S35A | NPN | light operate |
| OPDK 14N3901/S35A | NPN | dark operate |
| OPDK 14P1901/S35A | PNP | light operate |
| OPDK 14P3901/S35A | PNP | dark operate |

OPDK 14 Sb = 10 m

Retro-reflective sensors

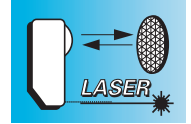

excess gain curve

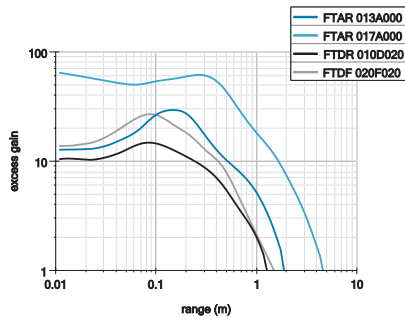
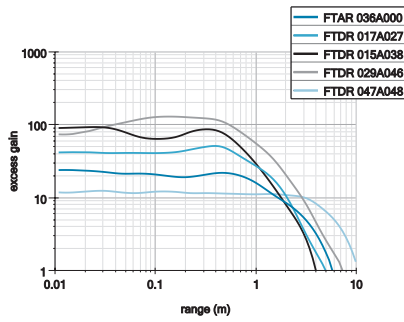

reflectors

| | |
|--------------|-----------------|
| FTAR 013A000 | ø 15 mm |
| FTAR 017A000 | ø 20,7 mm |
| FTAR 020A000 | ø 25,2 mm |
| FTAR 036A000 | ø 46 mm |
| FTDF 020F020 | tape 20 x 20 mm |
| FTDR 010D020 | 15 x 25 mm |
| FTDR 015A038 | 18 x 40 mm |
| FTDR 017A027 | 20 x 42 mm |
| FTDR 029A046 | 32,5 x 48 mm |
| FTDR 047A048 | 54 x 75 mm |

beam characteristic

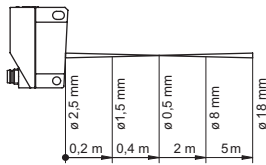

dimension drawing

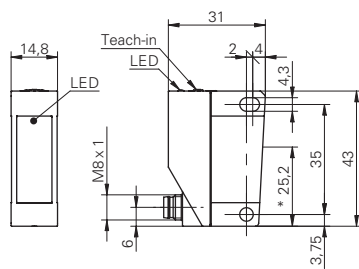

* emitter and receiver axis

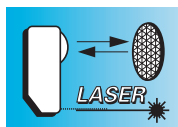

Sb = 1 m

- designed for detection of transparent objects
- single lens optics
- short response time



general data

| | |
|-------------------------|-------------------------------|
| type | retro-reflective laser sensor |
| special type | for transparent objects |
| version | single lens optics |
| light source | pulsed red laser diode |
| actual range Sb | 1 m |
| nominal range Sn | 1,5 m |
| repeatability | < 0,1 mm at laser focus |
| polarization filter | yes |
| light indicator | LED yellow |
| power on indication | LED green |
| sensitivity adjustment | Teach-in |
| laser class | 1 |
| distance to laser focus | 100 mm |
| wave length | 650 nm |

electrical data

| | |
|------------------------------|---------------|
| response time / release time | < 0,25 ms |
| voltage supply range +Vs | 10 ... 30 VDC |
| current consumption max. | 35 mA |
| current consumption typ. | 25 mA |
| voltage drop Vd | < 2,2 VDC |
| output circuit | PNP |
| output current | < 100 mA |
| short circuit protection | yes |
| reverse polarity protection | yes |

mechanical data

| | |
|------------------|---------------------|
| width / diameter | 14,8 mm |
| height / length | 43 mm |
| depth | 31 mm |
| type | rectangular |
| housing material | plastic (PA12) |
| front (optics) | PMMA |
| connection types | connector M8, 4 pin |

ambient conditions

| | |
|-----------------------|----------------|
| operating temperature | -10 ... +50 °C |
| protection class | IP 67 |

connection diagrams

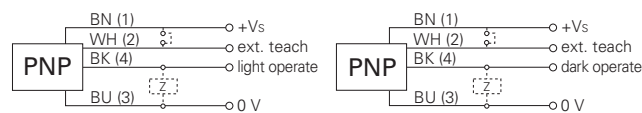

connectors

| | | |
|--------------|-------|--------------|
| ESG 32AH0200 | 4 pin | 2 m straight |
| ESW 31AH0200 | 4 pin | 2 m angular |

additional cable connectors and field wireable connectors, see accessories

accessories

| | |
|-----------------------|--------|
| SENSOFIX mounting kit | 149011 |
| mounting bracket | 134964 |

for details, see accessories section

laser warning

CLASS 1 LASER PRODUCT

Complies with 21 CFR 1040.10 and 1040.11 except for deviations pursuant to Laser Notice No. 50, dated July 26, 2001

Complies with EN60825-1:2001

| order reference | output function | teach value stored after power-off |
|-------------------|-----------------|------------------------------------|
| OPDK 14P1902/S35A | light operate | volatile |
| OPDK 14P1903/S35A | light operate | non volatile |
| OPDK 14P3902/S35A | dark operate | volatile |
| OPDK 14P3903/S35A | dark operate | non volatile |

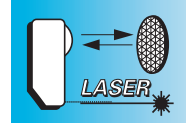

excess gain curve

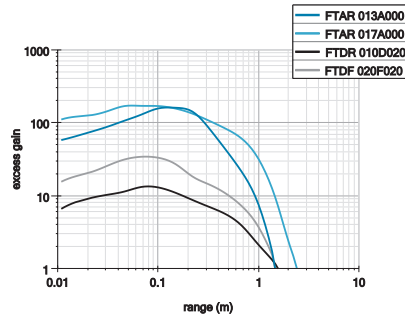
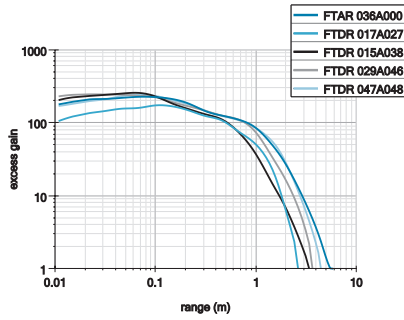

reflectors

| | |
|--------------|-----------------|
| FTAR 013A000 | ø 15 mm |
| FTAR 017A000 | ø 20,7 mm |
| FTAR 020A000 | ø 25,2 mm |
| FTAR 036A000 | ø 46 mm |
| FTDF 020F020 | tape 20 x 20 mm |
| FTDR 010D020 | 15 x 25 mm |
| FTDR 015A038 | 18 x 40 mm |
| FTDR 017A027 | 20 x 42 mm |
| FTDR 029A046 | 32,5 x 48 mm |
| FTDR 047A048 | 54 x 75 mm |

beam characteristic

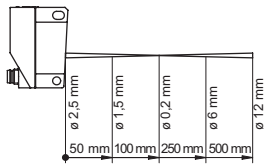

dimension drawing

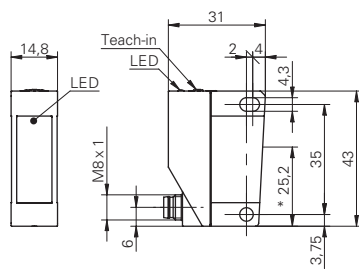

* emitter and receiver axis

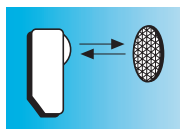
 $S_b = 7,3 \text{ m}$

- rugged metal housing
- sensing range adjustable via potentiometer
- polarization filter to detect shiny objects

general data

| | |
|-------------------------------------|--------------------------|
| type | retro-reflective sensor |
| light source | pulsed red LED |
| actual range S_b | 7,3 m |
| nominal range S_n | 9 m |
| polarization filter | yes |
| alignment / soiled lens indicator | flashing light indicator |
| light indicator | LED yellow |
| wave length | 660 nm |
| suppression of reciprocal influence | yes |

electrical data

| | |
|------------------------------|----------------------|
| response time / release time | < 1 ms |
| voltage supply range +Vs | 10 ... 30 VDC |
| current consumption max. | 36 mA |
| current consumption typ. | 26 mA |
| voltage drop V_d | < 1,8 VDC |
| output function | light / dark operate |
| output current | < 200 mA |
| short circuit protection | yes |
| reverse polarity protection | yes |

mechanical data

| | |
|------------------|---------------|
| width / diameter | 15,4 mm |
| height / length | 50 mm |
| depth | 50 mm |
| type | rectangular |
| housing material | die-cast zinc |
| front (optics) | PMMA |

ambient conditions

| | |
|-----------------------|----------------|
| operating temperature | -25 ... +65 °C |
| protection class | IP 67 |



connection diagrams

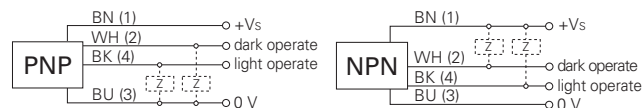

connectors

| | | |
|--------------|-------|--------------|
| ESG 34AH0200 | 4 pin | 2 m straight |
| ESW 33AH0200 | 4 pin | 2 m angular |

additional cable connectors and field wireable connectors, see accessories

accessories

| | |
|----------------------------------|--------|
| SENSOFIX mounting kit | 151721 |
| mounting bracket | 113917 |
| lens cleaning air nozzle bracket | 116407 |

for details, see accessories section

| order reference | connection types | output circuit | sensitivity adjustment |
|------------------|----------------------|----------------|------------------------|
| FPDM 16N5101 | cable 4 pin | NPN | no |
| FPDM 16N5101/S14 | connector M12, 4 pin | NPN | no |
| FPDM 16N5105 | cable 4 pin | NPN | Pot, 10 turn |
| FPDM 16N5105/S14 | connector M12, 4 pin | NPN | Pot, 10 turn |
| FPDM 16P5101 | cable 4 pin | PNP | no |
| FPDM 16P5101/S14 | connector M12, 4 pin | PNP | no |
| FPDM 16P5105 | cable 4 pin | PNP | Pot, 10 turn |
| FPDM 16P5105/S14 | connector M12, 4 pin | PNP | Pot, 10 turn |

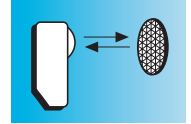

excess gain curve

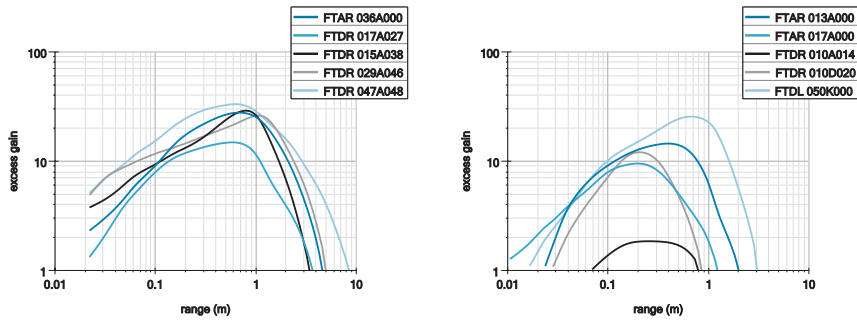

reflectors

| | |
|--------------------|------------------|
| FTAR 013A000 | ø 15 mm |
| FTAR 017A000 | ø 20,7 mm |
| FTAR 020A000 | ø 25,2 mm |
| FTAR 036A000 | ø 46 mm |
| FTDL 050K000/... m | tape 50 x ... mm |
| FTDR 010A014 | 12,8 x 16,8 mm |
| FTDR 010D020 | 15 x 25 mm |
| FTDR 015A038 | 18 x 40 mm |
| FTDR 017A027 | 20 x 42 mm |
| FTDR 029A046 | 32,5 x 48 mm |
| FTDR 047A048 | 54 x 75 mm |

dimension drawings

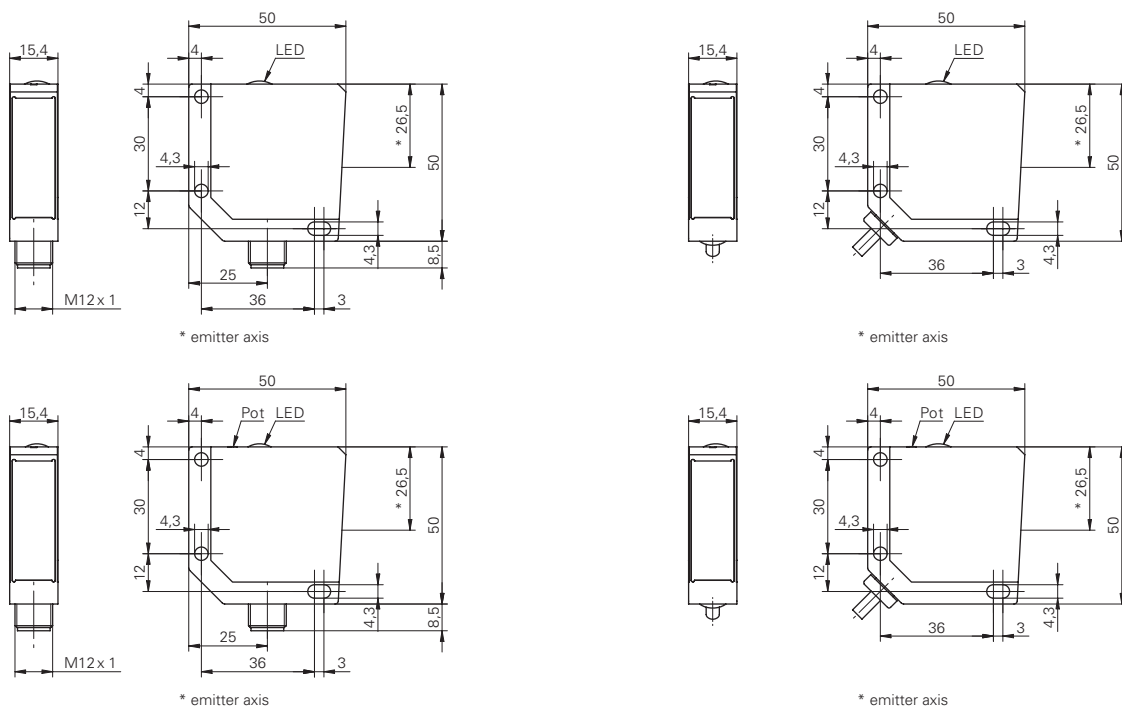

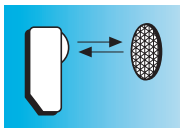

S_b = 6 m

- rugged metal housing
- designed for detection of transparent objects
- sensitivity adjustable via Teach-in



general data

| | |
|------------------------------|-------------------------|
| type | retro-reflective sensor |
| special type | for transparent objects |
| light source | pulsed red LED |
| actual range S _b | 4 m |
| nominal range S _n | 6 m |
| polarization filter | yes |
| light indicator | LED yellow |
| sensitivity adjustment | Teach-in |
| wave length | 660 nm |

electrical data

| | |
|------------------------------|---------------|
| response time / release time | < 2,5 ms |
| adaption time | < 25 ms |
| voltage supply range +Vs | 10 ... 30 VDC |
| current consumption max. | 50 mA |
| current consumption typ. | 40 mA |
| voltage drop V _d | < 1,8 VDC |
| output function | dark operate |
| output circuit | PNP |
| output current | < 200 mA |
| short circuit protection | yes |
| reverse polarity protection | yes |

mechanical data

| | |
|------------------|----------------------|
| width / diameter | 15,4 mm |
| height / length | 50 mm |
| depth | 50 mm |
| type | rectangular |
| housing material | die-cast zinc |
| front (optics) | PMMA |
| connection types | connector M12, 4 pin |

ambient conditions

| | |
|-----------------------|----------------|
| operating temperature | -25 ... +65 °C |
| protection class | IP 67 |

order reference

FPDM 16P3921/S14

connection diagram

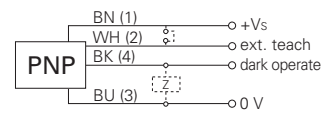

connectors

| | | |
|--------------|-------|--------------|
| ESG 34AH0200 | 4 pin | 2 m straight |
| ESW 33AH0200 | 4 pin | 2 m angular |

additional cable connectors and field wireable connectors, see accessories

accessories

| | |
|----------------------------------|--------|
| SENSOFIX mounting kit | 151721 |
| mounting bracket | 113917 |
| lens cleaning air nozzle bracket | 116407 |

for details, see accessories section

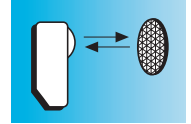

excess gain curve

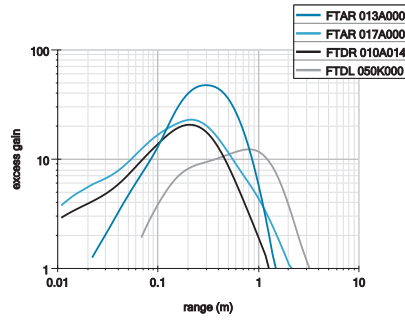
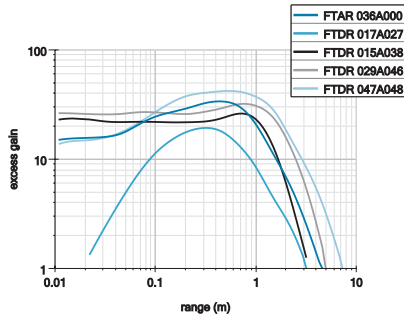

reflectors

| | |
|--------------------|------------------|
| FTAR 013A000 | ø 15 mm |
| FTAR 017A000 | ø 20,7 mm |
| FTAR 020A000 | ø 25,2 mm |
| FTAR 036A000 | ø 46 mm |
| FTDL 050K000/... m | tape 50 x ... mm |
| FTDR 010A014 | 12,8 x 16,8 mm |
| FTDR 015A038 | 18 x 40 mm |
| FTDR 017A027 | 20 x 42 mm |
| FTDR 029A046 | 32,5 x 48 mm |
| FTDR 047A048 | 54 x 75 mm |

dimension drawing

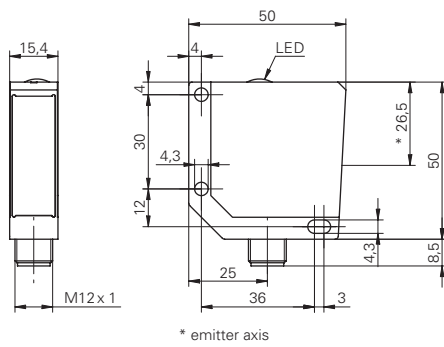

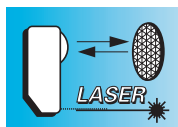

Sb = 11 m

- rugged metal housing
- high repeatability
- short response time



general data

| | |
|-----------------------------------|-------------------------------|
| type | retro-reflective laser sensor |
| light source | pulsed red laser diode |
| polarization filter | yes |
| alignment / soiled lens indicator | flashing light indicator |
| light indicator | LED yellow |
| laser class | 1 |
| wave length | 675 nm |
| actual range Sb = 1 m | |
| nominal range Sn | 1,3 m |
| repeatability | < 0,1 mm at laser focus |
| sensitivity adjustment | Pot, 270° |
| distance to laser focus | 80 mm |

| | |
|-------------------------------|-------------------------|
| actual range Sb = 11 m | |
| nominal range Sn | 12 m |
| repeatability | < 1,5 mm at 0 ... 0,5 m |
| sensitivity adjustment | no |
| distance to laser focus | 400 mm |

electrical data

| | |
|------------------------------|----------------------|
| response time / release time | < 0,1 ms |
| voltage supply range +Vs | 10 ... 30 VDC |
| current consumption max. | 70 mA |
| current consumption typ. | 60 mA |
| voltage drop Vd | < 1,8 VDC |
| output function | light / dark operate |
| output circuit | PNP |
| output current | < 200 mA |
| short circuit protection | yes |
| reverse polarity protection | yes |

mechanical data

| | |
|------------------|---------------|
| width / diameter | 15,4 mm |
| height / length | 50 mm |
| depth | 50 mm |
| type | rectangular |
| housing material | die-cast zinc |
| front (optics) | glass |

ambient conditions

| | |
|-----------------------|----------------|
| operating temperature | -10 ... +50 °C |
| protection class | IP 67 |

connection diagram

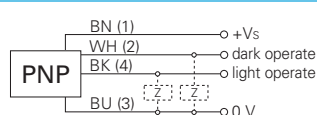

connectors

| | | |
|--------------|-------|--------------|
| ESG 34AH0200 | 4 pin | 2 m straight |
| ESW 33AH0200 | 4 pin | 2 m angular |

additional cable connectors and field wireable connectors, see accessories

accessories

| | |
|----------------------------------|--------|
| SENSOFIX mounting kit | 151721 |
| mounting bracket | 113917 |
| lens cleaning air nozzle bracket | 116407 |

for details, see accessories section

laser warning

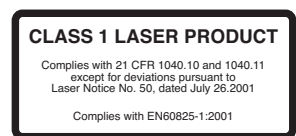

| order reference | actual range Sb | connection types |
|------------------|-----------------|----------------------|
| OPDM 16P5102 | 11 m | cable 4 pin |
| OPDM 16P5102/S14 | 11 m | connector M12, 4 pin |
| OPDM 16P5103 | 1 m | cable 4 pin |
| OPDM 16P5103/S14 | 1 m | connector M12, 4 pin |

OPDM 16 Sb = 11 m Retro-reflective sensors

excess gain curve

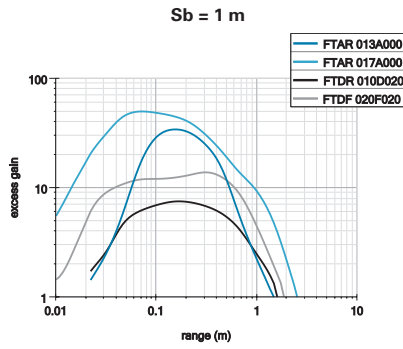
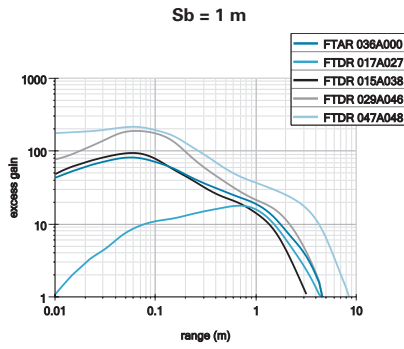
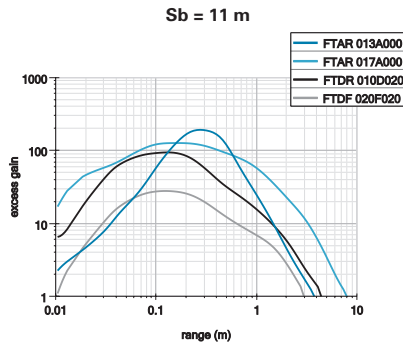
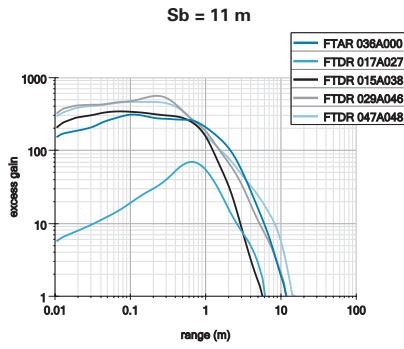

reflectors

| | |
|--------------|-----------------|
| FTAR 013A000 | ø 15 mm |
| FTAR 017A000 | ø 20,7 mm |
| FTAR 020A000 | ø 25,2 mm |
| FTAR 036A000 | ø 46 mm |
| FTDF 020F020 | tape 20 x 20 mm |
| FTDR 010D020 | 15 x 25 mm |
| FTDR 015A038 | 18 x 40 mm |
| FTDR 017A027 | 20 x 42 mm |
| FTDR 029A046 | 32,5 x 48 mm |
| FTDR 047A048 | 54 x 75 mm |

beam characteristic

Sb = 11 m

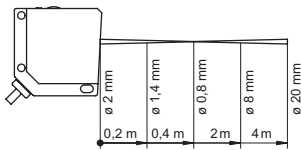

Sb = 1 m

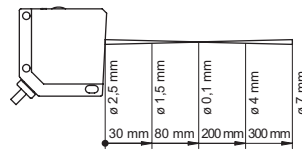

dimension drawings

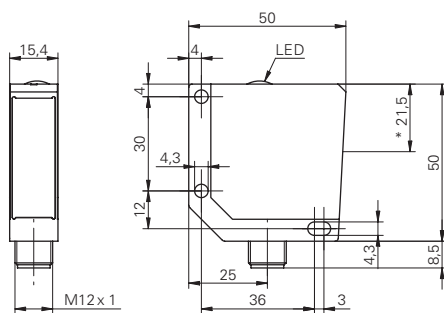

* emitter axis

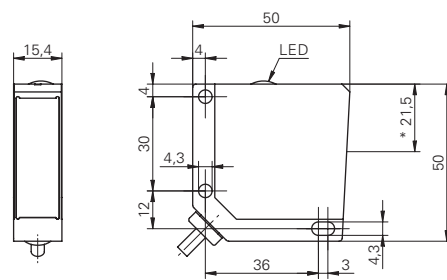

* emitter axis

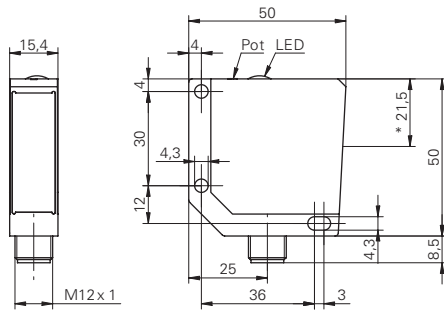

* emitter axis

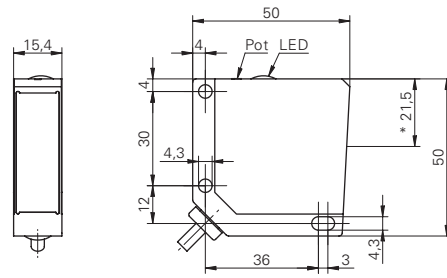

* emitter axis

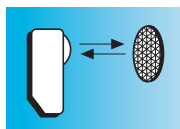

Sb = 3,2 m

- rugged metal housing
- polarization filter to detect shiny objects



general data

| | |
|-------------------------------------|--------------------------|
| type | retro-reflective sensor |
| light source | pulsed red LED |
| actual range Sb | 3,2 m |
| nominal range Sn | 4 m |
| polarization filter | yes |
| alignment / soiled lens indicator | flashing light indicator |
| light indicator | LED yellow |
| sensitivity adjustment | no |
| wave length | 660 nm |
| suppression of reciprocal influence | yes |

electrical data

| | |
|------------------------------|---------------|
| response time / release time | < 1 ms |
| voltage supply range +Vs | 10 ... 30 VDC |
| current consumption max. | 35 mA |
| current consumption typ. | 22 mA |
| voltage drop Vd | < 1,8 VDC |
| output function | dark operate |
| output current | < 200 mA |
| short circuit protection | yes |
| reverse polarity protection | yes |

mechanical data

| | |
|------------------|--------------------------|
| width / diameter | 18 mm |
| type | cylindrical |
| housing material | brass nickel plated / PC |
| front (optics) | PMMA |

ambient conditions

| | |
|-----------------------|----------------|
| operating temperature | -25 ... +55 °C |
| protection class | IP 67 |

connection diagrams

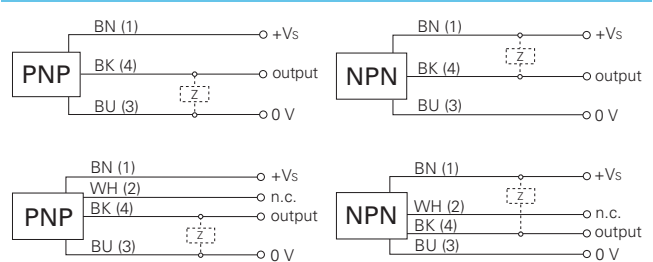

connectors

| | | |
|--------------|-------|--------------|
| ESG 34AH0200 | 4 pin | 2 m straight |
| ESW 33AH0200 | 4 pin | 2 m angular |

additional cable connectors and field wireable connectors, see accessories

accessories

| | |
|-----------------------|--------|
| SENSOFIX mounting kit | 151658 |
| glass cover | 103068 |
| doubling lens | 107250 |
| cap nut | 115913 |

for details, see accessories section

| order reference | connection types | height / length | output circuit |
|------------------|----------------------|-----------------|----------------|
| FPAM 18N3151 | cable 3 pin | 57 mm | NPN |
| FPAM 18N3151/S14 | connector M12, 4 pin | 67 mm | NPN |
| FPAM 18P3151 | cable 3 pin | 57 mm | PNP |
| FPAM 18P3151/S14 | connector M12, 4 pin | 67 mm | PNP |

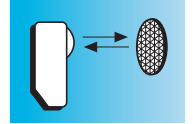

excess gain curve

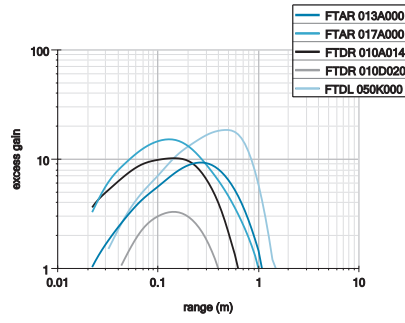
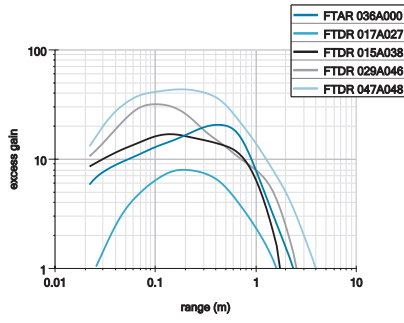

reflectors

| | |
|--------------------|------------------|
| FTAR 013A000 | ø 15 mm |
| FTAR 017A000 | ø 20,7 mm |
| FTAR 020A000 | ø 25,2 mm |
| FTAR 036A000 | ø 46 mm |
| FTDL 050K000/... m | tape 50 x ... mm |
| FTDR 010A014 | 12,8 x 16,8 mm |
| FTDR 010D020 | 15 x 25 mm |
| FTDR 015A038 | 18 x 40 mm |
| FTDR 017A027 | 20 x 42 mm |
| FTDR 029A046 | 32,5 x 48 mm |
| FTDR 047A048 | 54 x 75 mm |

dimension drawings

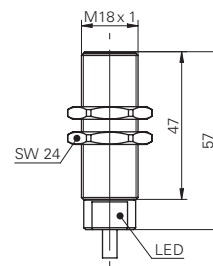
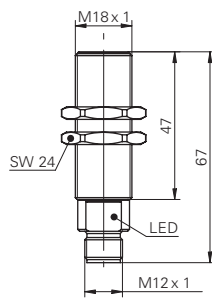

FPAM 18 Sb = 3,2 m

Retro-reflective sensors

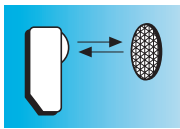

Sb = 4,5 m

- cross-technology housing concept
- polarization filter to detect shiny objects
- small mounting depth



general data

| | |
|-------------------------------------|--------------------------|
| type | retro-reflective sensor |
| light source | pulsed red LED |
| actual range Sb | 4,5 m |
| nominal range Sn | 5 m |
| polarization filter | yes |
| alignment / soiled lens indicator | flashing light indicator |
| light indicator | LED yellow |
| sensitivity adjustment | Pot, 270° |
| wave length | 660 nm |
| suppression of reciprocal influence | yes |

electrical data

| | |
|------------------------------|----------------------|
| response time / release time | < 0,5 ms |
| voltage supply range +Vs | 10 ... 30 VDC |
| current consumption max. | 25 mA |
| current consumption typ. | 22 mA |
| voltage drop Vd | < 1,8 VDC |
| output function | light / dark operate |
| output current | < 100 mA |
| short circuit protection | yes |
| reverse polarity protection | yes |

mechanical data

| | |
|------------------|---------------------|
| width / diameter | 20 mm |
| height / length | 42 mm |
| depth | 15 mm |
| type | rectangular |
| housing material | plastic (PBT-ASA) |
| front (optics) | PMMA |
| connection types | connector M8, 4 pin |

ambient conditions

| | |
|-----------------------|----------------|
| operating temperature | -25 ... +65 °C |
| protection class | IP 67 |

order reference output circuit

| | |
|-------------------|-----|
| FPDK 20N5101/S35A | NPN |
| FPDK 20P5101/S35A | PNP |

connection diagrams

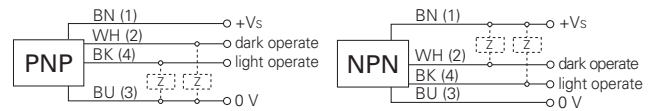

connectors

| | | |
|--------------|-------|--------------|
| ESG 32AH0200 | 4 pin | 2 m straight |
| ESW 31AH0200 | 4 pin | 2 m angular |

additional cable connectors and field wireable connectors, see accessories

accessories

| | |
|-----------------------|--------|
| SENSOFIX mounting kit | 150326 |
|-----------------------|--------|

for details, see accessories section

FPDK 20 Sb = 4,5 m

Retro-reflective sensors

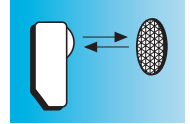

excess gain curve

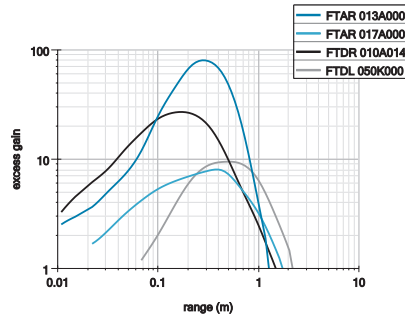
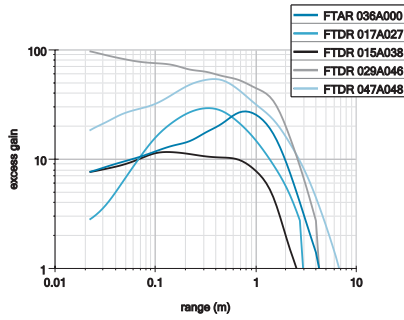

reflectors

| | |
|--------------------|------------------|
| FTAR 013A000 | ø 15 mm |
| FTAR 017A000 | ø 20,7 mm |
| FTAR 020A000 | ø 25,2 mm |
| FTAR 036A000 | ø 46 mm |
| FTDL 050K000/... m | tape 50 x ... mm |
| FTDR 010A014 | 12,8 x 16,8 mm |
| FTDR 015A038 | 18 x 40 mm |
| FTDR 017A027 | 20 x 42 mm |
| FTDR 029A046 | 32,5 x 48 mm |
| FTDR 047A048 | 54 x 75 mm |

dimension drawing

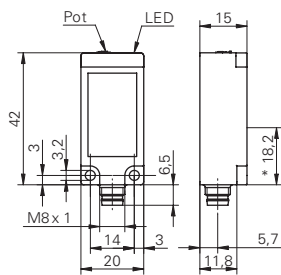

* emitter axis

FPDK 20 Sb = 4,5 m

Retro-reflective sensors

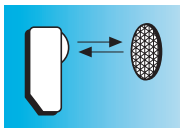

Sb = 10 m

- long sensing range
- polarization filter to detect shiny objects



general data

| | |
|-----------------------------------|--------------------------|
| type | retro-reflective sensor |
| light source | pulsed red LED |
| actual range Sb | 10 m |
| nominal range Sn | 11 m |
| polarization filter | yes |
| alignment / soiled lens indicator | flashing light indicator |
| light indicator | LED yellow |
| sensitivity adjustment | Pot, 270° |
| wave length | 660 nm |

electrical data

| | |
|------------------------------|----------------------|
| response time / release time | < 1 ms |
| voltage supply range +Vs | 10 ... 30 VDC |
| current consumption max. | 55 mA |
| current consumption typ. | 45 mA |
| voltage drop Vd | < 1,8 VDC |
| output function | light / dark operate |
| output current | < 200 mA |
| short circuit protection | yes |
| reverse polarity protection | yes |

mechanical data

| | |
|------------------|----------------------|
| width / diameter | 25 mm |
| height / length | 80 mm |
| depth | 58 mm |
| type | rectangular |
| housing material | plastic (ASA) |
| front (optics) | PMMA |
| connection types | connector M12, 4 pin |

ambient conditions

| | |
|-----------------------|----------------|
| operating temperature | -25 ... +65 °C |
| protection class | IP 67 |

| order reference | output circuit |
|------------------|----------------|
| FPDK 26N5103/S14 | NPN |
| FPDK 26P5103/S14 | PNP |

connection diagrams



connectors

| | | |
|--------------|-------|--------------|
| ESG 34AH0200 | 4 pin | 2 m straight |
| ESW 33AH0200 | 4 pin | 2 m angular |

additional cable connectors and field wireable connectors, see accessories

accessories

| | |
|------------------|--------|
| mounting bracket | 112477 |
|------------------|--------|

for details, see accessories section

FPDK 26 Sb = 10 m

Retro-reflective sensors

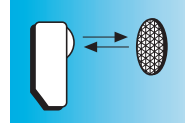

excess gain curve

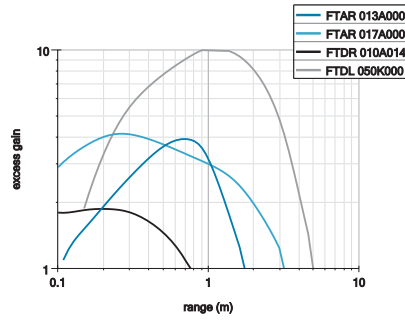
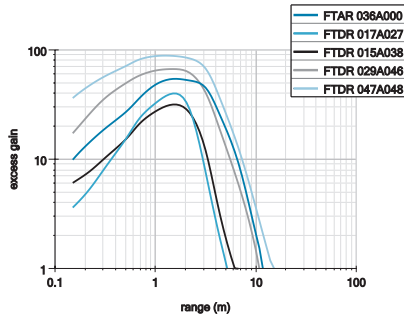

reflectors

| | |
|--------------------|------------------|
| FTAR 013A000 | ø 15 mm |
| FTAR 017A000 | ø 20,7 mm |
| FTAR 020A000 | ø 25,2 mm |
| FTAR 036A000 | ø 46 mm |
| FTDL 050K000/... m | tape 50 x ... mm |
| FTDR 010A014 | 12,8 x 16,8 mm |
| FTDR 015A038 | 18 x 40 mm |
| FTDR 017A027 | 20 x 42 mm |
| FTDR 029A046 | 32,5 x 48 mm |
| FTDR 047A048 | 54 x 75 mm |



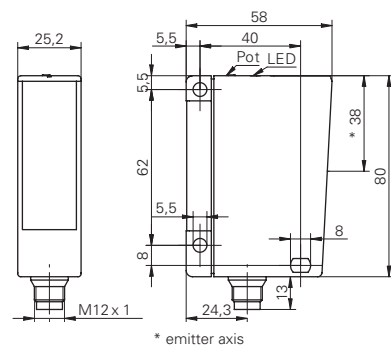
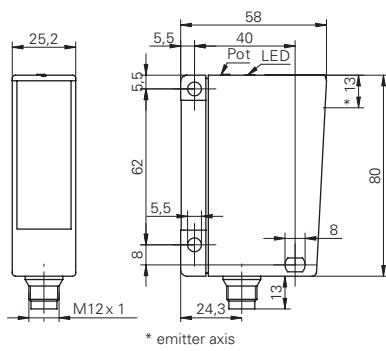



dimension drawings





FPDK 26 Sb = 10 m





Retro-reflective sensors

red light LED version

| product family | FSCK 07 / FECK 07 | FSDK 07 / FEDK 07 | FSDM 08 / FEDM 08 | FSDM 08 / FEDM 08 | FSAM 08 / FEAM 08 | FSDK 10 / FEDK 10 | FSDM 12 / FEDM 12 |
|------------------------------|---|---|---|---|---|---|---|
| |  |  |  |  |  |  |  |
| width / diameter | 8 mm | 8 mm | 8 mm | 8 mm | 8 mm | 10,4 mm | 12,4 mm |
| actual range Sb | 2 m | 2 m | 0,7 m | 2,5 m | 2,5 m | 5 m | 6 m |
| response time / release time | < 0,5 ms | < 0,5 ms | < 2,5 ms | < 2,5 ms | < 2,5 ms | < 1,4 ms | < 1 ms |
| sensitivity adjustment | Teach-in | Teach-in | no | no | no | Pot, 270° | no |
| NPN | ■ | ■ | | | | ■ | ■ |
| PNP | ■ | ■ | ■ | ■ | ■ | ■ | ■ |
| cable | ■ | ■ | ■ | ■ | ■ | ■ | ■ |
| connector | ■ | ■ | ■ | ■ | ■ | ■ | ■ |
| housing material | plastic | plastic | metal | metal | metal | plastic | metal |
| Page | 392 | 394 | 396 | 398 | 400 | 402 | 406 |

laser version

| product family | OSDK 10 / OEDK 10 | OSDK 14 / OEDK 14 | OSDM 16 / OEDM 16 |
|------------------------------|---|---|---|
| |  |  |  |
| width / diameter | 10,4 mm | 14,8 mm | 15,4 mm |
| actual range Sb | 8 m | 8 m | 8 m |
| response time / release time | < 0,2 ms | < 0,5 ms | < 0,1 ms |
| sensitivity adjustment | Pot, 270° | no | Pot, 270° |
| NPN | ■ | ■ | |
| PNP | ■ | ■ | ■ |
| cable | ■ | | ■ |
| connector | ■ | ■ | ■ |
| housing material | plastic | plastic | metal |
| Page | 404 | 410 | 414 |

| FSDK 14 / FEDK 14 | FSDM 16 / FEDM 16 | FSAM 18 / FEAM 18 | FSDK 20 / FEDK 20 | FSDK 26 / FEDK 26 |
|---|---|---|---|---|
|  |  |  |  |  |
| 14,8 mm | 15,4 mm | 18 mm | 20 mm | 25 mm |
| 12 m | 3 m 8 m | 16 m | 6 m | 20 m |
| < 1,2 ms | 0 ms | < 1 ms | < 0,5 ms | < 1 ms |
| no | no Pot, 10 turn | Pot, 270° | Pot, 270° | no |
| ■ | | ■ | ■ | |
| ■ | ■ | ■ | ■ | ■ |
| | ■ | ■ | | |
| ■ | ■ | ■ | ■ | ■ |
| plastic | metal | metal | plastic | plastic |
| 408 | 412 | 416 | 418 | 420 |

Through beam sensors



General information

An emitter in a separate housing transmits the light to a separate receiver. The object is detected when it breaks the emitted beam.

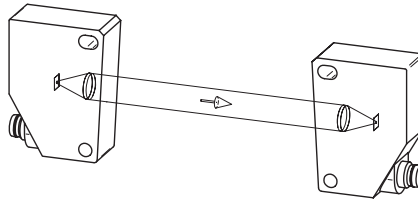

Applications

- Detection of objects at a great distance – through beam sensors have the longest ranges.
- Monitoring of doors and entrances
- Due to the good repeatability throughout the entire range, positioning of objects
- Reliable detection of high-gloss objects such as mirrors, wafers or chrome-plated surfaces

Characteristics and advantages

- Due to the separated configuration, long ranges with large signal excess gain can be achieved in comparison with equivalent retro-reflective systems. Through beam sensors are therefore most suitable for operation in unfavorable ambient conditions such as dirt, dust and moisture.
- The clearly defined, consistent active zone permits highly constant repeatability throughout the entire sensing distance.
- The switching point is independent of the surface properties of the object.

Through beam sensors



Technology and operation

The active area (A) of a through beam sensor is equal to the diameter of the lens of the receiver or emitter. The acceptance zone (B) of the emitter and receiver is larger. However, this is only important for adjustment and for operation close to glossy surfaces. With focused through beam laser sensors, the active area is the diameter of the laser beam if this is smaller than the receiver lens or the front opening at the receiver end.

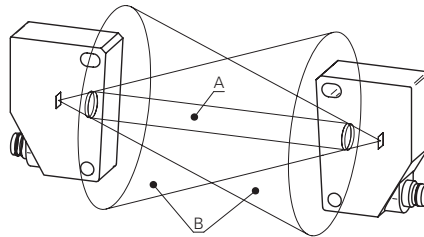

Mounting and adjustment

The emitter and receiver must be aimed at each other. The narrower the angle of radiation and reception, the more accurately this must be conducted.

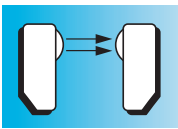

Sb = 2 m

- ultra compact housing
- sensing range adjustable via Teach-in
- test input

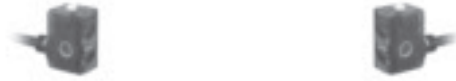
**general data**

| | |
|------------------|---------------------|
| type | through beam sensor |
| actual range Sb | 2 m |
| nominal range Sn | 2,5 m |

receiver

| | |
|-----------------------------------|--------------------------|
| alignment / soiled lens indicator | flashing light indicator |
| light indicator | LED green |
| output indicator | LED yellow |
| sensitivity adjustment | Teach-in |

emitter

| | |
|--------------|----------------|
| light source | pulsed red LED |
| wave length | 660 nm |

electrical data

| | |
|-----------------------------|---------------|
| voltage supply range +Vs | 10 ... 30 VDC |
| current consumption max. | 20 mA |
| reverse polarity protection | yes |

receiver

| | |
|------------------------------|----------------------|
| response time / release time | < 0,5 ms |
| current consumption typ. | 20 mA |
| voltage drop Vd | < 1,8 VDC |
| output function | light / dark operate |
| output current | < 100 mA |
| short circuit protection | yes |

emitter

| | |
|--------------------------|-------|
| current consumption typ. | 12 mA |
|--------------------------|-------|

mechanical data

| | |
|------------------|--------------------------|
| width / diameter | 8 mm |
| height / length | 16,2 mm |
| depth | 10,8 mm |
| type | rectangular |
| housing material | plastic (PMMA, MABS, PA) |
| front (optics) | PMMA |

ambient conditions

| | |
|-----------------------|----------------|
| operating temperature | -20 ... +50 °C |
| protection class | IP 65 |

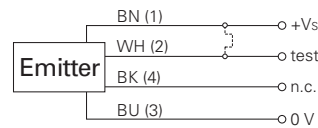
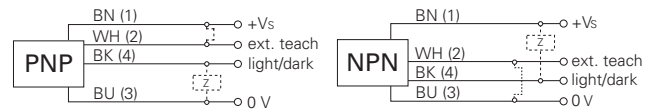
connection diagrams**connectors**

| | | |
|--------------|-------|--------------|
| ESG 32AH0200 | 4 pin | 2 m straight |
| ESW 31AH0200 | 4 pin | 2 m angular |

additional cable connectors and field wireable connectors, see accessories

accessories

| | |
|----------------------|--------|
| MINOFIX mounting kit | 150844 |
|----------------------|--------|

for details, see accessories section

| order reference | emitter / receiver | connection types | output circuit |
|--------------------|--------------------|-----------------------------|----------------|
| FECK 07N6901 | receiver | cable rear side | NPN |
| FECK 07N6901/KS35A | receiver | flylead connector M8, 4 pin | NPN |
| FECK 07P6901 | receiver | cable rear side | PNP |
| FECK 07P6901/KS35A | receiver | flylead connector M8, 4 pin | PNP |
| FSCK 07D9601 | emitter | cable rear side | - |
| FSCK 07D9601/KS35A | emitter | flylead connector M8, 4 pin | - |

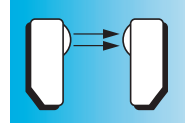

excess gain curve

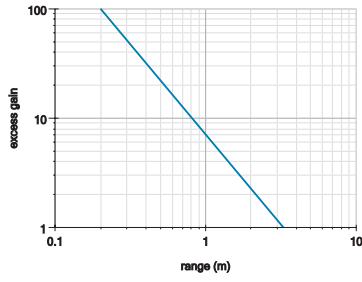

dimension drawings

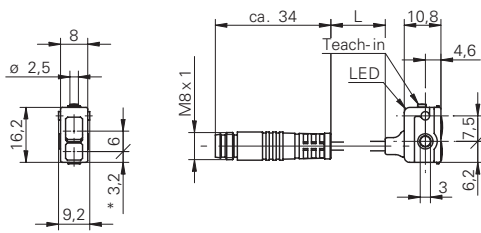

* receiver axis cable length L = 200 mm

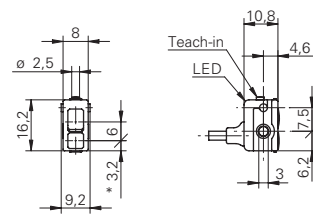

* receiver axis

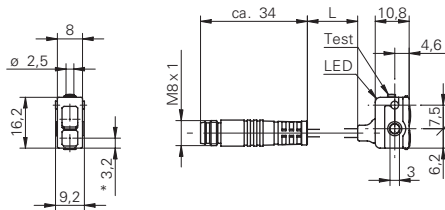

* emitter axis cable length L = 200 mm

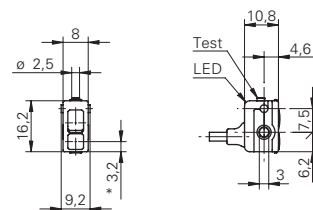

* emitter axis

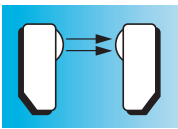

Sb = 2 m

- ultra compact housing
- sensing range adjustable via Teach-in
- test input

**general data**

| | |
|------------------|---------------------|
| type | through beam sensor |
| actual range Sb | 2 m |
| nominal range Sn | 2,5 m |

receiver

| | |
|-----------------------------------|--------------------------|
| alignment / soiled lens indicator | flashing light indicator |
| light indicator | LED green |
| output indicator | LED yellow |
| sensitivity adjustment | Teach-in |

emitter

| | |
|--------------|----------------|
| light source | pulsed red LED |
| wave length | 660 nm |

electrical data

| | |
|-----------------------------|---------------|
| voltage supply range +Vs | 10 ... 30 VDC |
| current consumption max. | 20 mA |
| reverse polarity protection | yes |

receiver

| | |
|------------------------------|----------------------|
| response time / release time | < 0,5 ms |
| current consumption typ. | 20 mA |
| voltage drop Vd | < 1,8 VDC |
| output function | light / dark operate |
| output current | < 100 mA |
| short circuit protection | yes |

emitter

| | |
|--------------------------|-------|
| current consumption typ. | 12 mA |
|--------------------------|-------|

mechanical data

| | |
|------------------|--------------------------|
| width / diameter | 8 mm |
| height / length | 16,2 mm |
| depth | 10,8 mm |
| type | rectangular |
| housing material | plastic (PMMA, MABS, PA) |
| front (optics) | PMMA |

ambient conditions

| | |
|-----------------------|----------------|
| operating temperature | -20 ... +50 °C |
| protection class | IP 65 |

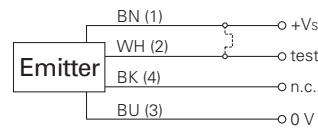
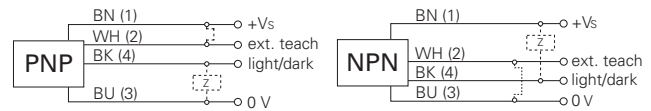
connection diagrams**connectors**

| | | |
|--------------|-------|--------------|
| ESG 32AH0200 | 4 pin | 2 m straight |
| ESW 31AH0200 | 4 pin | 2 m angular |

additional cable connectors and field wireable connectors, see accessories

accessories

| | |
|----------------------|--------|
| MINOFIX mounting kit | 150844 |
|----------------------|--------|

for details, see accessories section

| order reference | emitter / receiver | connection types | output circuit |
|--------------------|--------------------|-----------------------------|----------------|
| FEDK 07N6901 | receiver | cable bottom side | NPN |
| FEDK 07N6901/KS35A | receiver | flylead connector M8, 4 pin | NPN |
| FEDK 07P6901 | receiver | cable bottom side | PNP |
| FEDK 07P6901/KS35A | receiver | flylead connector M8, 4 pin | PNP |
| FSDK 07D9601 | emitter | cable bottom side | - |
| FSDK 07D9601/KS35A | emitter | flylead connector M8, 4 pin | - |

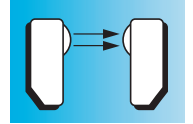

excess gain curve

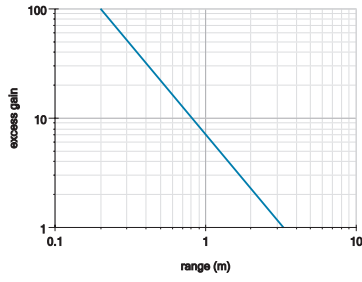

dimension drawings

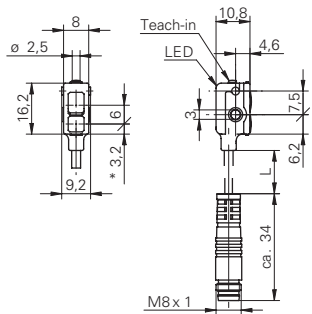

* receiver axis cable length L = 200 mm

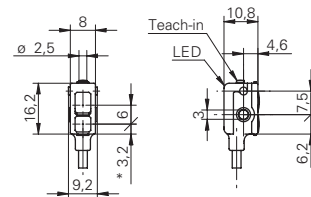

* receiver axis

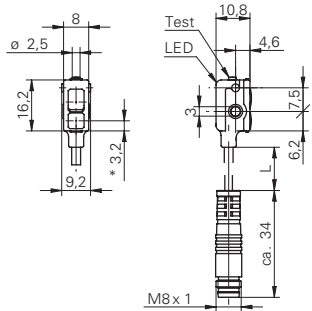

* emitter axis cable length L = 200 mm

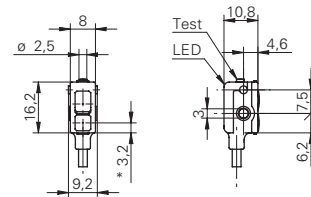

* emitter axis

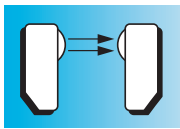

$S_b = 0,7 \text{ m}$

- subminiature metal housing
- small rectangular design



general data

| | |
|---------------------|---------------------|
| type | through beam sensor |
| actual range S_b | 0,7 m |
| nominal range S_n | 1 m |

receiver

| | |
|-----------------------------------|--------------------------|
| alignment / soiled lens indicator | flashing light indicator |
| light indicator | LED red |
| sensitivity adjustment | no |

emitter

| | |
|--------------|-----------------------|
| light source | pulsed infrared diode |
| wave length | 880 nm |

electrical data

| | |
|-----------------------------|---------------|
| voltage supply range +Vs | 10 ... 30 VDC |
| reverse polarity protection | yes |

receiver

| | |
|------------------------------|----------|
| response time / release time | < 2,5 ms |
| current consumption max. | 24 mA |
| current consumption typ. | 24 mA |
| voltage drop V_d | < 2 VDC |
| output circuit | PNP |
| output current | < 100 mA |
| short circuit protection | yes |

emitter

| | |
|--------------------------|-------|
| current consumption max. | 48 mA |
| current consumption typ. | 17 mA |

mechanical data

| | |
|------------------|-------------------|
| width / diameter | 8 mm |
| height / length | 58 mm |
| depth | 12 mm |
| type | rectangular |
| housing material | aluminum anodized |
| front (optics) | PC |

ambient conditions

| | |
|-----------------------|----------------|
| operating temperature | -25 ... +65 °C |
| protection class | IP 65 |

connection diagrams

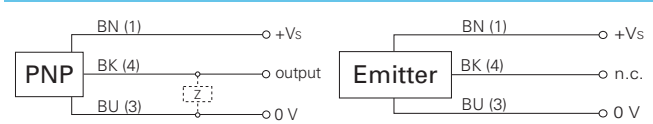

connectors

| | | |
|--------------|-------|--------------|
| ESG 32SH0200 | 3 pin | 2 m straight |
| ESW 31SH0200 | 3 pin | 2 m angular |

additional cable connectors and field wireable connectors, see accessories

accessories

| | |
|-----------------------|--------|
| SENSOFIX mounting kit | 151719 |
|-----------------------|--------|

for details, see accessories section

| order reference | emitter / receiver | connection types | output function |
|-------------------|--------------------|---------------------|-----------------|
| FEDM 08P1001 | receiver | cable 3 pin | light operate |
| FEDM 08P1001/S35L | receiver | connector M8, 3 pin | light operate |
| FEDM 08P3001 | receiver | cable 3 pin | dark operate |
| FEDM 08P3001/S35L | receiver | connector M8, 3 pin | dark operate |
| FSDM 08D9001 | emitter | cable 3 pin | - |
| FSDM 08D9001/S35 | emitter | connector M8, 3 pin | - |

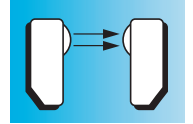

excess gain curve

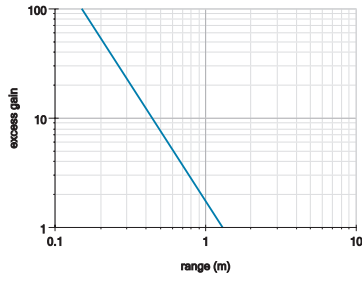

dimension drawings

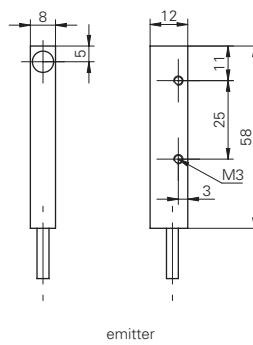
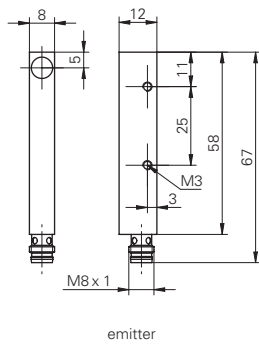
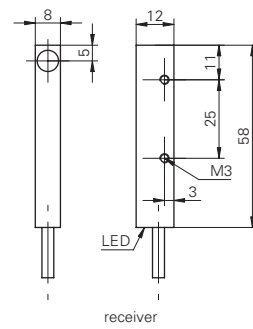
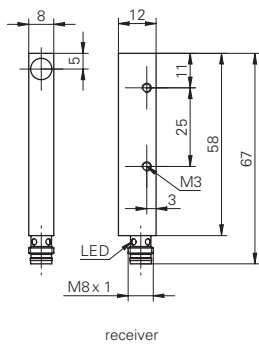

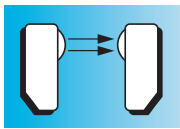

Sb = 2,5 m

- subminiature metal housing
- small rectangular design

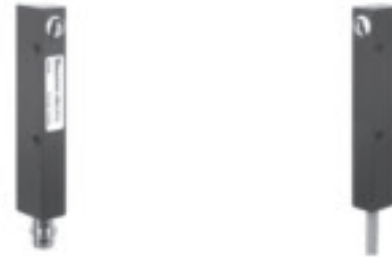
**general data**

| | |
|------------------|---------------------|
| type | through beam sensor |
| actual range Sb | 2,5 m |
| nominal range Sn | 3 m |

receiver

| | |
|-----------------------------------|--------------------------|
| alignment / soiled lens indicator | flashing light indicator |
| light indicator | LED red |
| sensitivity adjustment | no |

emitter

| | |
|--------------|-----------------------|
| light source | pulsed infrared diode |
| wave length | 880 nm |

electrical data

| | |
|-----------------------------|---------------|
| voltage supply range +Vs | 10 ... 30 VDC |
| reverse polarity protection | yes |

receiver

| | |
|------------------------------|----------|
| response time / release time | < 2,5 ms |
| current consumption max. | 24 mA |
| current consumption typ. | 24 mA |
| voltage drop Vd | < 2 VDC |
| output circuit | PNP |
| output current | < 100 mA |
| short circuit protection | yes |

emitter

| | |
|--------------------------|-------|
| current consumption max. | 48 mA |
| current consumption typ. | 17 mA |

mechanical data

| | |
|------------------|-------------------|
| width / diameter | 8 mm |
| height / length | 58 mm |
| depth | 15 mm |
| type | rectangular |
| housing material | aluminum anodized |
| front (optics) | PC |

ambient conditions

| | |
|-----------------------|----------------|
| operating temperature | -25 ... +65 °C |
| protection class | IP 65 |

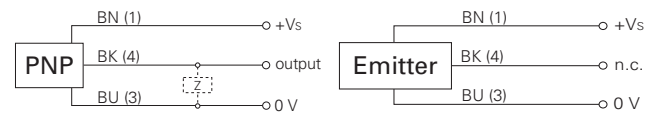
connection diagrams**connectors**

| | | |
|--------------|-------|--------------|
| ESG 32SH0200 | 3 pin | 2 m straight |
| ESW 31SH0200 | 3 pin | 2 m angular |

additional cable connectors and field wireable connectors, see accessories

accessories

| | |
|-----------------------|--------|
| SENSOFIX mounting kit | 151719 |
|-----------------------|--------|

for details, see accessories section

| order reference | emitter / receiver | connection types | output function |
|-------------------|--------------------|---------------------|-----------------|
| FEDM 08P1002 | receiver | cable 3 pin | light operate |
| FEDM 08P1002/S35L | receiver | connector M8, 3 pin | light operate |
| FEDM 08P3002 | receiver | cable 3 pin | dark operate |
| FEDM 08P3002/S35L | receiver | connector M8, 3 pin | dark operate |
| FSDM 08D9002 | emitter | cable 3 pin | - |
| FSDM 08D9002/S35 | emitter | connector M8, 3 pin | - |

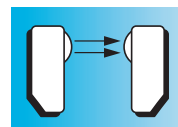

excess gain curve

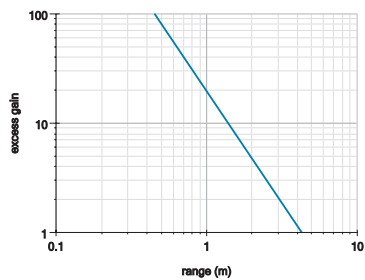

dimension drawings

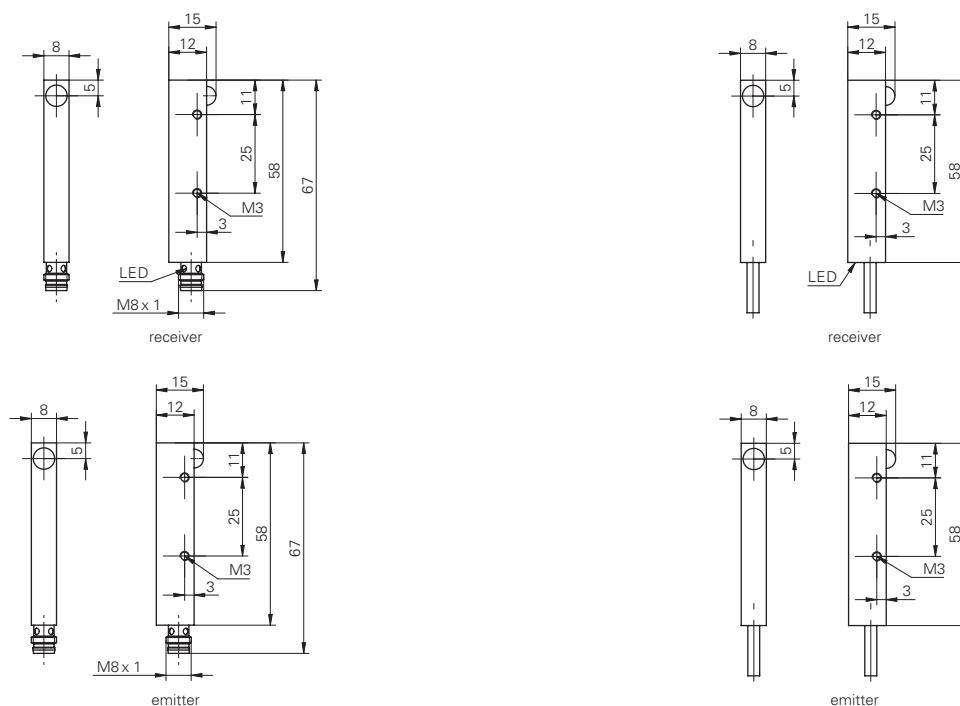

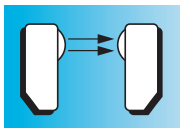

Sb = 2,5 m

- subminiature metal housing
- cylindrical design

**general data**

| | |
|------------------|---------------------|
| type | through beam sensor |
| actual range Sb | 2,5 m |
| nominal range Sn | 3 m |

receiver

| | |
|-----------------------------------|--------------------------|
| alignment / soiled lens indicator | flashing light indicator |
| light indicator | LED red |
| sensitivity adjustment | no |

emitter

| | |
|--------------|-----------------------|
| light source | pulsed infrared diode |
| wave length | 880 nm |

electrical data

| | |
|-----------------------------|---------------|
| voltage supply range +Vs | 10 ... 30 VDC |
| reverse polarity protection | yes |

receiver

| | |
|------------------------------|----------|
| response time / release time | < 2,5 ms |
| current consumption max. | 24 mA |
| current consumption typ. | 24 mA |
| voltage drop Vd | < 2 VDC |
| output circuit | PNP |
| output current | < 100 mA |
| short circuit protection | yes |

emitter

| | |
|--------------------------|-------|
| current consumption max. | 48 mA |
| current consumption typ. | 17 mA |

mechanical data

| | |
|------------------|---------------------|
| width / diameter | 8 mm |
| type | cylindrical |
| housing material | brass nickel plated |
| front (optics) | PC |

ambient conditions

| | |
|-----------------------|----------------|
| operating temperature | -25 ... +65 °C |
| protection class | IP 65 |

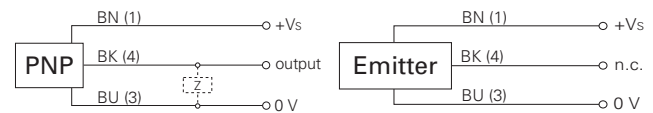
connection diagrams**connectors**

| | | |
|--------------|-------|--------------|
| ESG 32SH0200 | 3 pin | 2 m straight |
| ESW 31SH0200 | 3 pin | 2 m angular |

additional cable connectors and field wireable connectors, see accessories

accessories

| | |
|-----------------------|--------|
| SENSOFIX mounting kit | 151719 |
|-----------------------|--------|

for details, see accessories section

| order reference | emitter / receiver | connection types | height / length | output function |
|-------------------|--------------------|---------------------|-----------------|-----------------|
| FEAM 08P1002 | receiver | cable 3 pin | 59 mm | light operate |
| FEAM 08P1002/S35L | receiver | connector M8, 3 pin | 75,5 mm | light operate |
| FEAM 08P3002 | receiver | cable 3 pin | 59 mm | dark operate |
| FEAM 08P3002/S35L | receiver | connector M8, 3 pin | 75,5 mm | dark operate |
| FSAM 08D9002 | emitter | cable 3 pin | 59 mm | - |
| FSAM 08D9002/S35 | emitter | connector M8, 3 pin | 75,5 mm | - |

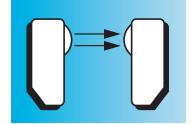

excess gain curve

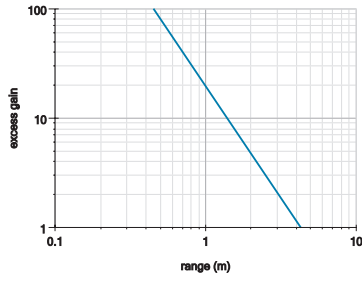

dimension drawings

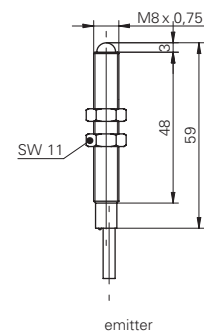
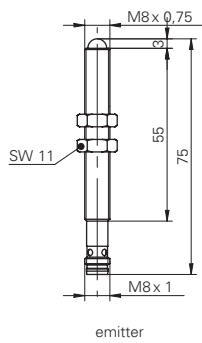
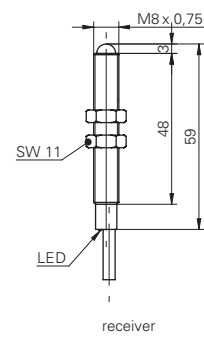
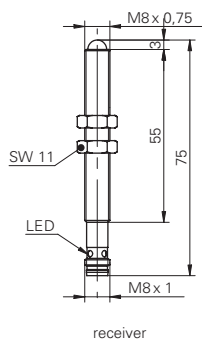

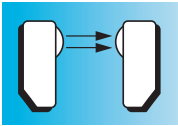

Sb = 5 m

- subminiature housing
- sensing range adjustable via potentiometer
- test input



general data

| | |
|------------------|---------------------|
| type | through beam sensor |
| actual range Sb | 5 m |
| nominal range Sn | 6 m |

receiver

| | |
|-----------------------------------|--------------------------|
| alignment / soiled lens indicator | flashing light indicator |
| light indicator | LED yellow |
| sensitivity adjustment | Pot, 270° |

emitter

| | |
|--------------|----------------|
| light source | pulsed red LED |
| wave length | 660 nm |

electrical data

| | |
|-----------------------------|---------------|
| voltage supply range +Vs | 10 ... 30 VDC |
| reverse polarity protection | yes |

receiver

| | |
|------------------------------|-----------|
| response time / release time | < 1,4 ms |
| current consumption max. | 16 mA |
| current consumption typ. | 16 mA |
| voltage drop Vd | < 1,8 VDC |
| output current | < 100 mA |
| short circuit protection | yes |

emitter

| | |
|--------------------------|-------|
| current consumption max. | 23 mA |
| current consumption typ. | 15 mA |

mechanical data

| | |
|------------------|---------------|
| width / diameter | 10,4 mm |
| height / length | 27 mm |
| depth | 14 mm |
| type | rectangular |
| housing material | plastic (ASA) |
| front (optics) | PMMA |

ambient conditions

| | |
|-----------------------|----------------|
| operating temperature | -25 ... +65 °C |
|-----------------------|----------------|

connection diagrams

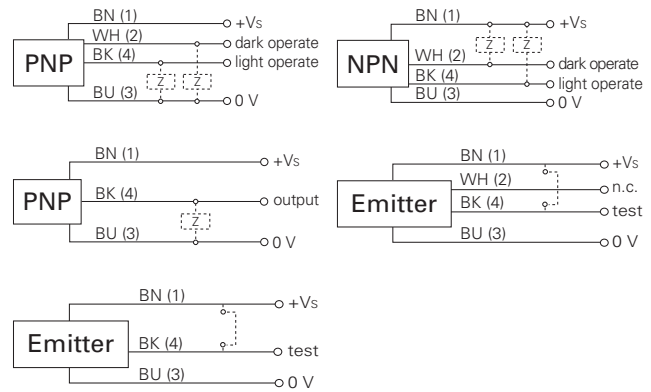

connectors

| | | |
|--------------|-------|--------------|
| ESG 32SH0200 | 3 pin | 2 m straight |
| ESW 31SH0200 | 3 pin | 2 m angular |
| ESG 32AH0200 | 4 pin | 2 m straight |
| ESW 31AH0200 | 4 pin | 2 m angular |

additional cable connectors and field wireable connectors, see accessories

accessories

| | |
|-----------------------------------|--------|
| SENSOFIX mounting kit | 150326 |
| mounting bracket (cable type) | 114501 |
| mounting bracket (connector type) | 133792 |

for details, see accessories section

| order reference | emitter / receiver | connection types | output circuit | output function | protection class |
|-------------------|--------------------|-----------------------------|----------------|----------------------|------------------|
| FEDK 10N5101 | receiver | cable 4 pin | NPN | light / dark operate | IP 65 |
| FEDK 10N5101/S35A | receiver | connector M8, 4 pin | NPN | light / dark operate | IP 67 |
| FEDK 10P1101/KS35 | receiver | flylead connector M8, 3 pin | PNP | light operate | IP 65 |
| FEDK 10P3101/KS35 | receiver | flylead connector M8, 3 pin | PNP | dark operate | IP 65 |
| FEDK 10P5101 | receiver | cable 4 pin | PNP | light / dark operate | IP 65 |
| FEDK 10P5101/S35A | receiver | connector M8, 4 pin | PNP | light / dark operate | IP 67 |
| FSDK 10D9001/KS35 | emitter | flylead connector M8, 3 pin | - | - | IP 65 |
| FSDK 10D9601 | emitter | cable 4 pin | - | - | IP 65 |
| FSDK 10D9601/S35A | emitter | connector M8, 4 pin | - | - | IP 67 |

FSDK 10 / FEDK 10 Sb = 5 m Through beam sensors

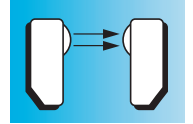

excess gain curve

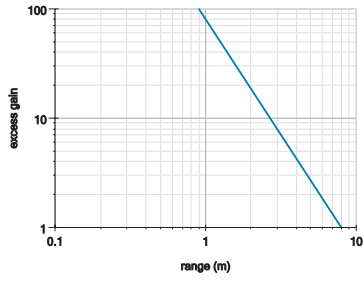

dimension drawings

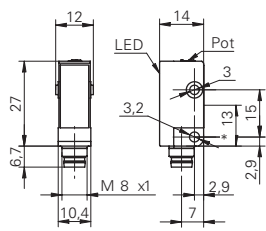

* receiver axis

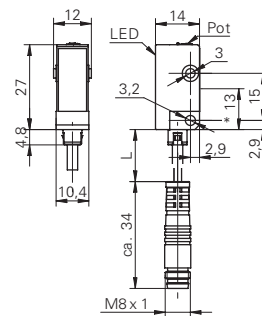

* receiver axis cable length L = 200 mm

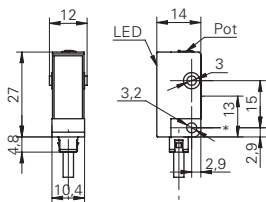

* receiver axis

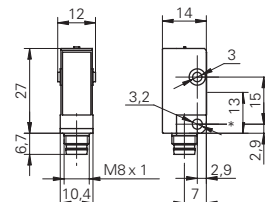

* emitter axis

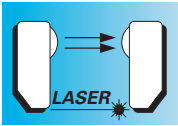

Sb = 8 m

- long range
- short response time



general data

| | |
|------------------|---------------------------|
| type | through beam laser sensor |
| actual range Sb | 8 m |
| nominal range Sn | 10 m |

receiver

| | |
|-----------------------------------|--------------------------|
| alignment / soiled lens indicator | flashing light indicator |
| light indicator | LED yellow |
| sensitivity adjustment | Pot, 270° |

emitter

| | |
|-------------------------|------------------------|
| light source | pulsed red laser diode |
| laser class | 2 |
| distance to laser focus | parallel beam |
| wave length | 675 nm |

electrical data

| | |
|-----------------------------|---------------|
| voltage supply range +Vs | 10 ... 30 VDC |
| reverse polarity protection | yes |

receiver

| | |
|------------------------------|----------------------|
| response time / release time | < 0,2 ms |
| current consumption max. | 16 mA |
| current consumption typ. | 15 mA |
| voltage drop Vd | < 1,8 VDC |
| output function | light / dark operate |
| output current | < 100 mA |
| short circuit protection | yes |

emitter

| | |
|--------------------------|-------|
| current consumption max. | 50 mA |
| current consumption typ. | 40 mA |

mechanical data

| | |
|------------------|---------------|
| width / diameter | 10,4 mm |
| height / length | 27 mm |
| type | rectangular |
| housing material | plastic (ASA) |
| front (optics) | PMMA |

receiver

| | |
|-------|-------|
| depth | 14 mm |
|-------|-------|

emitter

| | |
|-------|---------|
| depth | 16,3 mm |
|-------|---------|

ambient conditions

receiver

| | |
|-----------------------|----------------|
| operating temperature | -25 ... +65 °C |
|-----------------------|----------------|

emitter

| | |
|-----------------------|----------------|
| operating temperature | -10 ... +50 °C |
|-----------------------|----------------|

connection diagrams

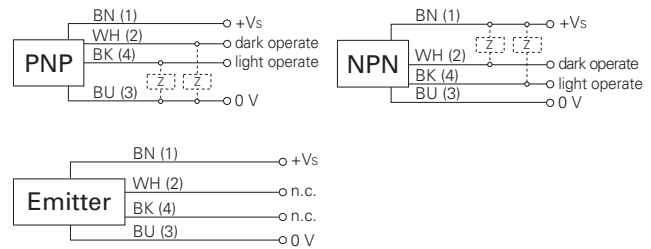

connectors

| | | |
|--------------|-------|--------------|
| ESG 32AH0200 | 4 pin | 2 m straight |
| ESW 31AH0200 | 4 pin | 2 m angular |

additional cable connectors and field wireable connectors, see accessories

accessories

| | |
|-----------------------------------|--------|
| SENSOFIX mounting kit | 150326 |
| mounting bracket (cable type) | 114501 |
| mounting bracket (connector type) | 133792 |

for details, see accessories section

laser warning



OSDK 10 / OEDK 10 Sb = 8 m Through beam sensors

| order reference | emitter / receiver | connection types | output circuit | protection class |
|-------------------|--------------------|---------------------|----------------|------------------|
| OEDK 10N5101 | receiver | cable 4 pin | NPN | IP 65 |
| OEDK 10N5101/S35A | receiver | connector M8, 4 pin | NPN | IP 67 |
| OEDK 10P5101 | receiver | cable 4 pin | PNP | IP 65 |
| OEDK 10P5101/S35A | receiver | connector M8, 4 pin | PNP | IP 67 |
| OSDK 10D9001 | emitter | cable 4 pin | - | IP 65 |
| OSDK 10D9001/S35A | emitter | connector M8, 4 pin | - | IP 67 |

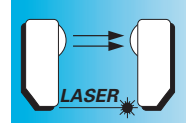

excess gain curve

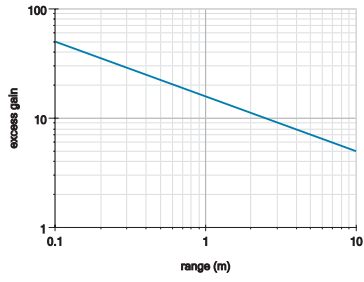

beam characteristic

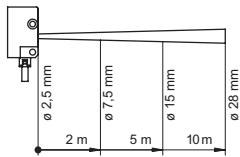

dimension drawings

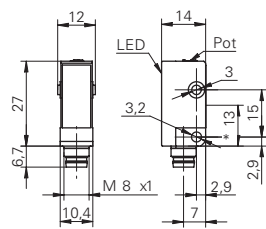

* receiver axis

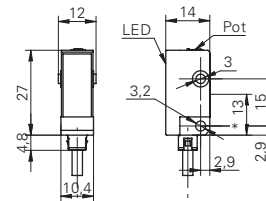

* receiver axis

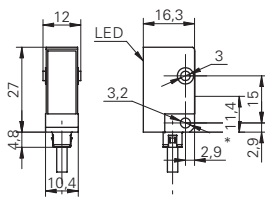

* emitter axis

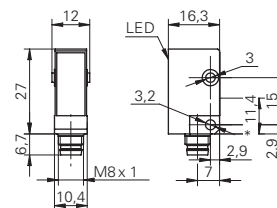

* emitter axis

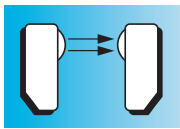
S_b = 6 m

- rugged miniature metal housing
- test input

**general data**

| | |
|------------------------------|---------------------|
| type | through beam sensor |
| actual range S _b | 6 m |
| nominal range S _n | 7,5 m |

receiver

| | |
|-----------------------------------|--------------------------|
| alignment / soiled lens indicator | flashing light indicator |
| light indicator | LED yellow |
| sensitivity adjustment | no |

emitter

| | |
|--------------|----------------|
| light source | pulsed red LED |
| wave length | 660 nm |

electrical data

| | |
|-----------------------------|---------------|
| voltage supply range +Vs | 10 ... 30 VDC |
| reverse polarity protection | yes |

receiver

| | |
|------------------------------|-----------|
| response time / release time | < 1 ms |
| current consumption max. | 17 mA |
| current consumption typ. | 17 mA |
| voltage drop V _d | < 1,8 VDC |
| output current | < 100 mA |
| short circuit protection | yes |

emitter

| | |
|--------------------------|-------|
| current consumption max. | 30 mA |
| current consumption typ. | 18 mA |

mechanical data

| | |
|------------------|---------------|
| width / diameter | 12,4 mm |
| height / length | 35 mm |
| depth | 35 mm |
| type | rectangular |
| housing material | die-cast zinc |
| front (optics) | PMMA |

ambient conditions

| | |
|-----------------------|----------------|
| operating temperature | -25 ... +65 °C |
| protection class | IP 67 |

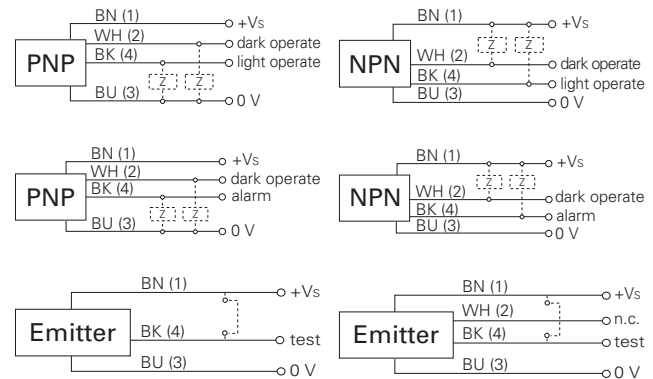
connection diagrams**connectors**

| | | |
|--------------|-------|--------------|
| ESG 32AH0200 | 4 pin | 2 m straight |
| ESW 31AH0200 | 4 pin | 2 m angular |

additional cable connectors and field wireable connectors, see accessories

accessories

| | |
|-----------------------|--------|
| SENSOFIX mounting kit | 150328 |
| mounting bracket | 113873 |

for details, see accessories section

| order reference | emitter / receiver | connection types | output circuit | output function |
|-------------------|--------------------|---------------------|----------------|----------------------|
| FEDM 12N3401 | receiver | cable 4 pin | NPN | alarm output dark |
| FEDM 12N3401/S35A | receiver | connector M8, 4 pin | NPN | alarm output dark |
| FEDM 12N5101 | receiver | cable 4 pin | NPN | light / dark operate |
| FEDM 12N5101/S35A | receiver | connector M8, 4 pin | NPN | light / dark operate |
| FEDM 12P3401 | receiver | cable 4 pin | PNP | alarm output dark |
| FEDM 12P3401/S35A | receiver | connector M8, 4 pin | PNP | alarm output dark |
| FEDM 12P5101 | receiver | cable 4 pin | PNP | light / dark operate |
| FEDM 12P5101/S35A | receiver | connector M8, 4 pin | PNP | light / dark operate |
| FSDM 12D9601 | emitter | cable 3 pin | - | - |
| FSDM 12D9601/S35A | emitter | connector M8, 4 pin | - | - |

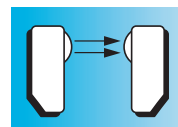

excess gain curve

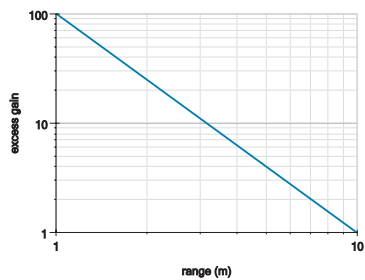

dimension drawings

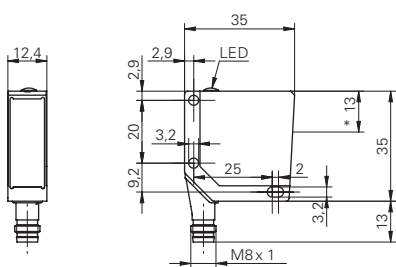

* receiver axis

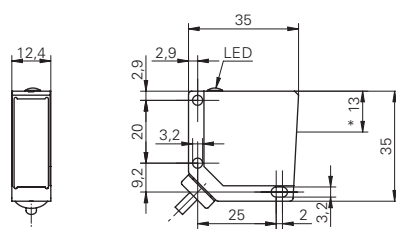

* receiver axis

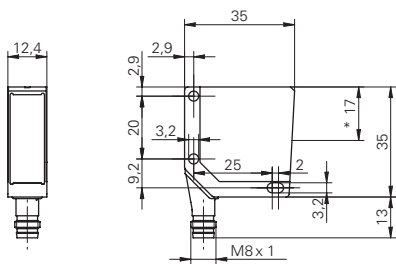

* emitter axis

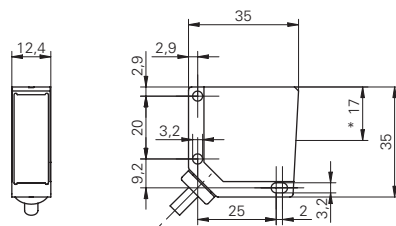

* emitter axis

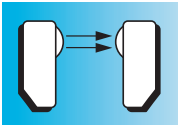
S_b = 12 m

- long range
- test input

**general data**

| | |
|------------------------------|---------------------|
| type | through beam sensor |
| actual range S _b | 12 m |
| nominal range S _n | 15 m |

receiver

| | |
|-----------------------------------|--------------------------|
| alignment / soiled lens indicator | flashing light indicator |
| light indicator | LED yellow |
| sensitivity adjustment | no |

emitter

| | |
|--------------|----------------|
| light source | pulsed red LED |
| wave length | 660 nm |

electrical data

| | |
|--------------------------------------|---------------|
| voltage supply range +V _s | 10 ... 30 VDC |
| current consumption max. | 20 mA |
| reverse polarity protection | yes |

receiver

| | |
|------------------------------|----------------------|
| response time / release time | < 1,2 ms |
| current consumption typ. | 20 mA |
| voltage drop V _d | < 1,8 VDC |
| output function | light / dark operate |
| output current | < 100 mA |
| short circuit protection | yes |

emitter

| | |
|--------------------------|-------|
| current consumption typ. | 12 mA |
|--------------------------|-------|

mechanical data

| | |
|------------------|---------------------|
| width / diameter | 14,8 mm |
| height / length | 43 mm |
| depth | 31 mm |
| type | rectangular |
| housing material | plastic (PA12) |
| front (optics) | PA |
| connection types | connector M8, 4 pin |

ambient conditions

| | |
|-----------------------|----------------|
| operating temperature | -25 ... +65 °C |
| protection class | IP 67 |

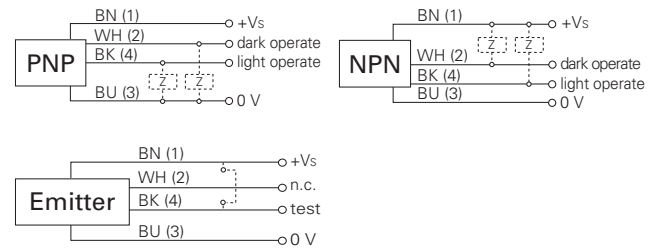
connection diagrams**connectors**

| | | |
|--------------|-------|--------------|
| ESG 32AH0200 | 4 pin | 2 m straight |
| ESW 31AH0200 | 4 pin | 2 m angular |

additional cable connectors and field wireable connectors, see accessories

accessories

| | |
|------------------------|--------|
| SENSOFIX mounting kit | 149011 |
| mounting bracket | 134964 |
| slot aperture stickers | 144075 |

for details, see accessories section

| order reference | emitter / receiver | output circuit |
|-------------------|--------------------|----------------|
| FEDK 14N5101/S35A | receiver | NPN |
| FEDK 14P5101/S35A | receiver | PNP |
| FSDK 14D9601/S35A | emitter | - |

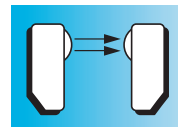

excess gain curve

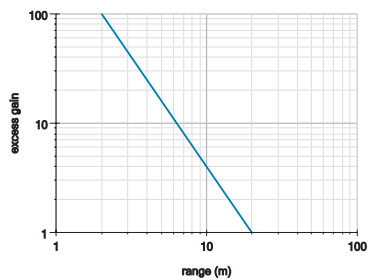

dimension drawings

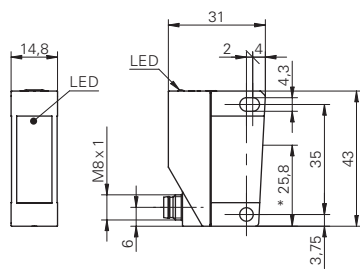

* receiver axis

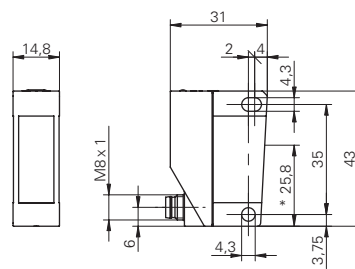

* emitter axis

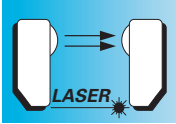
S_b = 8 m

- long range
- short response time

**general data**

| | |
|------------------------------|---------------------------|
| type | through beam laser sensor |
| actual range S _b | 8 m |
| nominal range S _n | 10 m |

receiver

| | |
|-----------------------------------|--------------------------|
| alignment / soiled lens indicator | flashing light indicator |
| light indicator | LED yellow |
| sensitivity adjustment | no |

emitter

| | |
|-------------------------|------------------------|
| light source | pulsed red laser diode |
| power on indication | LED green |
| laser class | 1 |
| distance to laser focus | parallel beam |
| wave length | 650 nm |

electrical data

| | |
|-----------------------------|---------------|
| voltage supply range +Vs | 10 ... 30 VDC |
| reverse polarity protection | yes |

receiver

| | |
|------------------------------|----------------------|
| response time / release time | < 0,5 ms |
| current consumption max. | 20 mA |
| current consumption typ. | 20 mA |
| voltage drop V _d | < 1,8 VDC |
| output function | light / dark operate |
| output current | < 100 mA |
| short circuit protection | yes |

emitter

| | |
|--------------------------|-------|
| current consumption max. | 35 mA |
| current consumption typ. | 25 mA |

mechanical data

| | |
|------------------|---------------------|
| width / diameter | 14,8 mm |
| height / length | 43 mm |
| depth | 31 mm |
| type | rectangular |
| housing material | plastic (PA12) |
| front (optics) | PMMA |
| connection types | connector M8, 4 pin |

ambient conditions

| | |
|------------------|-------|
| protection class | IP 67 |
|------------------|-------|

receiver

| | |
|-----------------------|----------------|
| operating temperature | -25 ... +65 °C |
|-----------------------|----------------|

emitter

| | |
|-----------------------|---------------|
| operating temperature | 10 ... +50 °C |
|-----------------------|---------------|

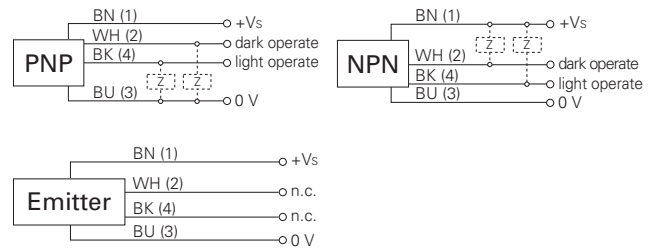
connection diagrams**connectors**

| | | |
|--------------|-------|--------------|
| ESG 32AH0200 | 4 pin | 2 m straight |
| ESW 31AH0200 | 4 pin | 2 m angular |

additional cable connectors and field wireable connectors, see accessories

accessories

| | |
|-----------------------|--------|
| SENSOFIX mounting kit | 149011 |
| mounting bracket | 134964 |

for details, see accessories section

laser warning**CLASS 1 LASER PRODUCT**Complies with 21 CFR 1040.10 and 1040.11
except for deviations pursuant to
Laser Notice No. 50, dated July 26, 2001

Complies with EN60825-1:2001

| order reference | emitter / receiver | output circuit |
|-------------------|--------------------|----------------|
| OEDK 14N5101/S35A | receiver | NPN |
| OEDK 14P5101/S35A | receiver | PNP |
| OSDK 14D9001/S35A | emitter | - |

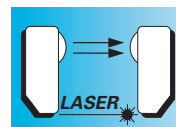

excess gain curve

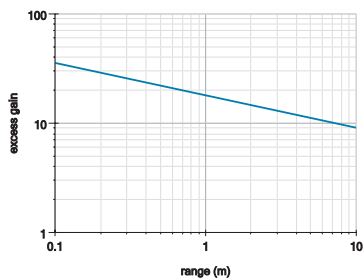

beam characteristic

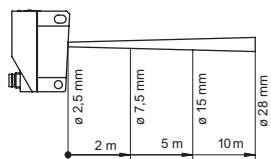

dimension drawings

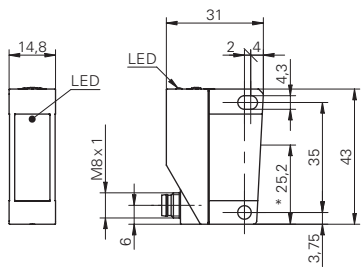

* receiver axis

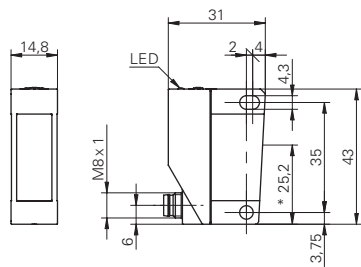

* emitter axis

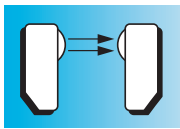

$S_b = 8\text{ m}$

- rugged metal housing
- sensing range adjustable via potentiometer



general data

type through beam sensor

receiver

alignment / soiled lens indicator flashing light indicator

light indicator LED yellow

emitter

light source pulsed red LED

wave length 660 nm

electrical data

voltage supply range +Vs 10 ... 30 VDC

reverse polarity protection yes

receiver

response time / release time < 1 ms

current consumption max. 17 mA

current consumption typ. 17 mA

voltage drop Vd < 1,8 VDC

output function light / dark operate

output circuit PNP

output current < 200 mA

short circuit protection yes

emitter

current consumption max. 30 mA

current consumption typ. 18 mA

test input Disable emitter: +Vs
Enable emitter: 0 V

mechanical data

width / diameter 15,4 mm

height / length 50 mm

depth 50 mm

type rectangular

housing material die-cast zinc

front (optics) PMMA

ambient conditions

operating temperature -25 ... +65 °C

protection class IP 67

connection diagrams

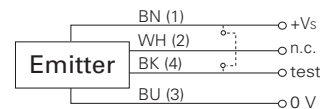
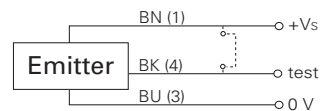
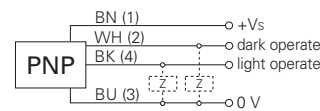

connectors

ESG 34AH0200 4 pin 2 m straight

ESW 33AH0200 4 pin 2 m angular

additional cable connectors and field wireable connectors, see accessories

accessories

SENSOFIX mounting kit 151721

mounting bracket 113917

lens cleaning air nozzle bracket 116407

for details, see accessories section

| order reference | emitter / receiver | nominal range S_n | actual range S_b | connection types | sensitivity adjustment |
|------------------|--------------------|---------------------|--------------------|----------------------|------------------------|
| FEDM 16P5101 | receiver | 10 m | 8 m | cable 4 pin | no |
| FEDM 16P5101/S14 | receiver | 10 m | 8 m | connector M12, 4 pin | no |
| FEDM 16P5105 | receiver | 3,5 m | 3 m | cable 4 pin | Pot, 10 turn |
| FEDM 16P5105/S14 | receiver | 3,5 m | 3 m | connector M12, 4 pin | Pot, 10 turn |
| FSDM 16D9601 | emitter | 10 m | 8 m | cable 3 pin | - |
| FSDM 16D9601/S14 | emitter | 10 m | 8 m | connector M12, 4 pin | - |

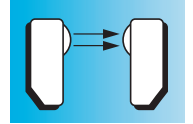

excess gain curve

Sb = 8 m

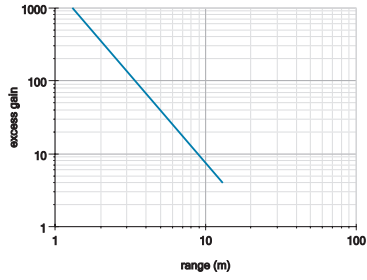

Sb = 3 m

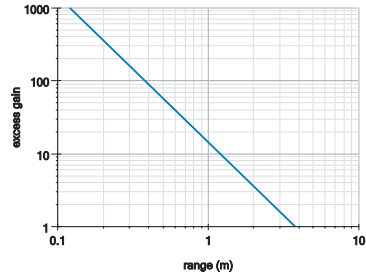

dimension drawings

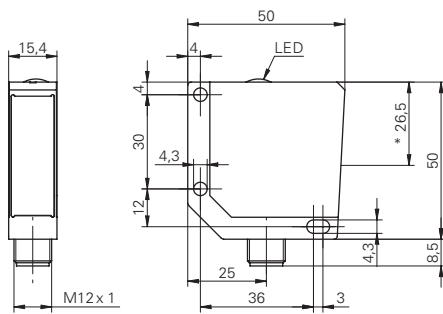

* receiver axis

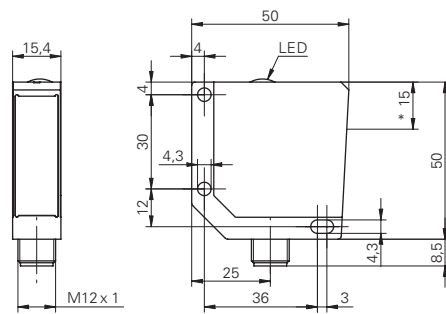

* receiver axis

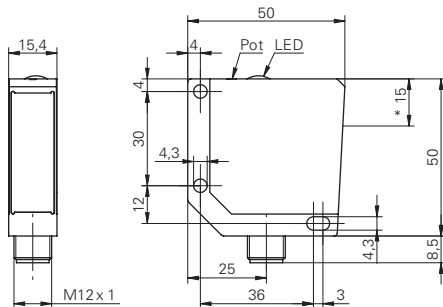

* receiver axis

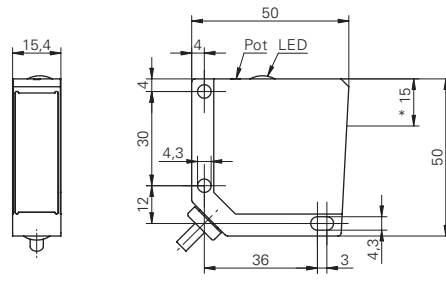

* receiver axis

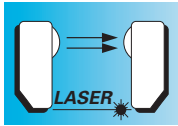

Sb = 8 m

- long range
- short response time



general data

| | |
|-----------------------------------|---------------------------|
| type | through beam laser sensor |
| actual range Sb | 8 m |
| receiver | |
| nominal range Sn | 10 m |
| alignment / soiled lens indicator | LED green |
| output indicator | LED yellow |
| sensitivity adjustment | Pot, 270° |
| emitter | |
| light source | pulsed red laser diode |
| repeatability | < 0,4 mm at laser focus |
| laser class | 1 |
| distance to laser focus | 400 mm |
| wave length | 675 nm |

electrical data

| | |
|------------------------------|---------------|
| voltage supply range +Vs | 10 ... 30 VDC |
| reverse polarity protection | yes |
| receiver | |
| response time / release time | < 0,1 ms |
| current consumption max. | 30 mA |
| current consumption typ. | 30 mA |
| voltage drop Vd | < 1,8 VDC |
| output circuit | PNP |
| output current | < 200 mA |
| short circuit protection | yes |
| emitter | |
| current consumption max. | 75 mA |
| current consumption typ. | 60 mA |

mechanical data

| | |
|------------------|---------------|
| width / diameter | 15,4 mm |
| height / length | 50 mm |
| depth | 50 mm |
| type | rectangular |
| housing material | die-cast zinc |
| front (optics) | glass |

ambient conditions

| | |
|-----------------------|----------------|
| protection class | IP 67 |
| receiver | |
| operating temperature | -25 ... +65 °C |
| emitter | |
| operating temperature | 10 ... +50 °C |

connection diagrams

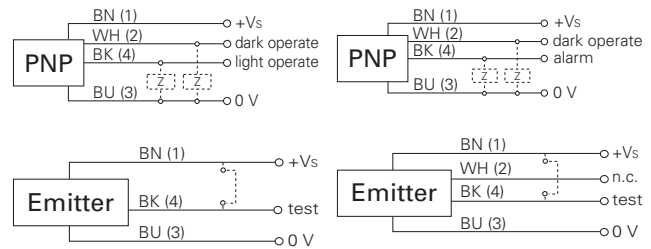

connectors

| | | |
|--|-------|--------------|
| ESG 34AH0200 | 4 pin | 2 m straight |
| ESW 33AH0200 | 4 pin | 2 m angular |
| additional cable connectors and field wireable connectors, see accessories | | |

accessories

| | |
|--------------------------------------|--------|
| SENSOFIX mounting kit | 151721 |
| mounting bracket emitter | 119373 |
| mounting bracket receiver | 113917 |
| lens cleaning air nozzle bracket | 116407 |
| for details, see accessories section | |

laser warning

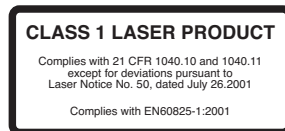

| order reference | emitter / receiver | connection types | output function |
|------------------|--------------------|----------------------|----------------------|
| OEDM 16P3401 | receiver | cable 4 pin | alarm output dark |
| OEDM 16P3401/S14 | receiver | connector M12, 4 pin | alarm output dark |
| OEDM 16P5101 | receiver | cable 4 pin | light / dark operate |
| OEDM 16P5101/S14 | receiver | connector M12, 4 pin | light / dark operate |
| OSDM 16D9601 | emitter | cable 3 pin | - |
| OSDM 16D9601/S14 | emitter | connector M12, 4 pin | - |

OSDM 16 / OEDM 16 Sb = 8 m Through beam sensors

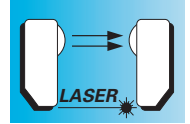

excess gain curve

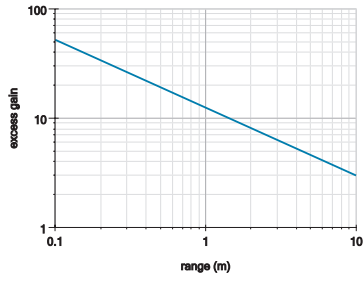

beam characteristic

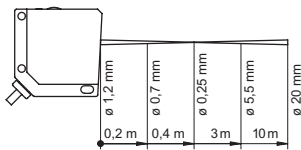

dimension drawings

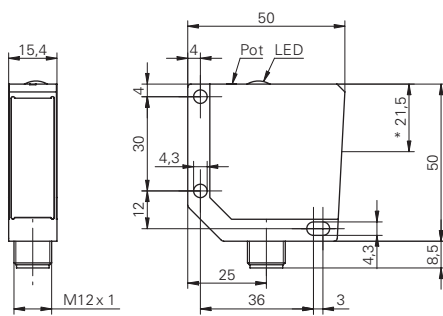

* receiver axis

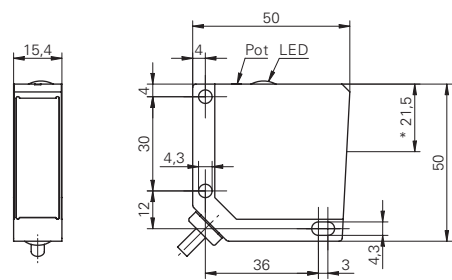

* receiver axis

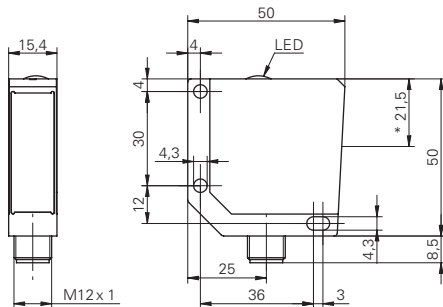

* emitter axis

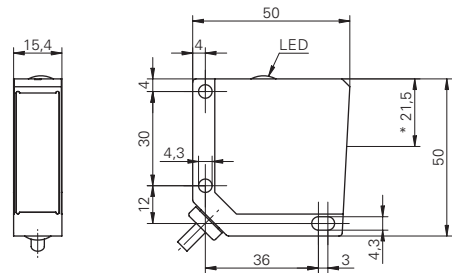

* emitter axis

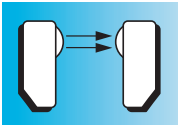

Sb = 16 m

- subminiature metal housing
- cylindrical design



general data

| | |
|------------------|---------------------|
| type | through beam sensor |
| actual range Sb | 16 m |
| nominal range Sn | 20 m |

receiver

| | |
|-----------------------------------|--------------------------|
| alignment / soiled lens indicator | flashing light indicator |
| light indicator | LED yellow |
| sensitivity adjustment | Pot, 270° |

emitter

| | |
|--------------|-----------------------|
| light source | pulsed infrared diode |
| wave length | 880 nm |

electrical data

| | |
|-----------------------------|---------------|
| voltage supply range +Vs | 10 ... 30 VDC |
| reverse polarity protection | yes |

receiver

| | |
|------------------------------|--------------|
| response time / release time | < 1 ms |
| current consumption max. | 20 mA |
| current consumption typ. | 20 mA |
| voltage drop Vd | < 1,8 VDC |
| output function | dark operate |
| output current | < 200 mA |
| short circuit protection | yes |

emitter

| | |
|--------------------------|-------|
| current consumption max. | 40 mA |
| current consumption typ. | 30 mA |

mechanical data

| | |
|------------------|--------------------------|
| width / diameter | 18 mm |
| type | cylindrical |
| housing material | brass nickel plated / PC |
| front (optics) | PC |

ambient conditions

| | |
|-----------------------|----------------|
| operating temperature | -25 ... +55 °C |
| protection class | IP 67 |

connection diagrams

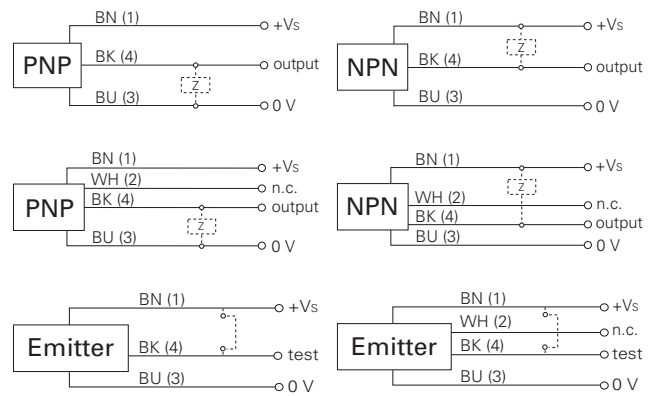

connectors

| | | |
|--------------|-------|--------------|
| ESG 34AH0200 | 4 pin | 2 m straight |
| ESW 33AH0200 | 4 pin | 2 m angular |

additional cable connectors and field wireable connectors, see accessories

accessories

| | |
|-----------------------|--------|
| SENSOFIX mounting kit | 151658 |
| glass cover | 103068 |
| cap nut | 101480 |

for details, see accessories section

| order reference | emitter / receiver | connection types | height / length | output circuit |
|------------------|--------------------|----------------------|-----------------|----------------|
| FEAM 18N3150 | receiver | cable 3 pin | 57 mm | NPN |
| FEAM 18N3150/S14 | receiver | connector M12, 4 pin | 67 mm | NPN |
| FEAM 18P3150 | receiver | cable 3 pin | 57 mm | PNP |
| FEAM 18P3150/S14 | receiver | connector M12, 4 pin | 67 mm | PNP |
| FSAM 18D9651 | emitter | cable 3 pin | 57 mm | - |
| FSAM 18D9651/S14 | emitter | connector M12, 4 pin | 67 mm | - |

FSAM 18 / FEAM 18 Sb = 16 m

Through beam sensors

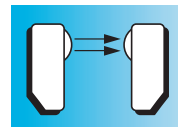

excess gain curve

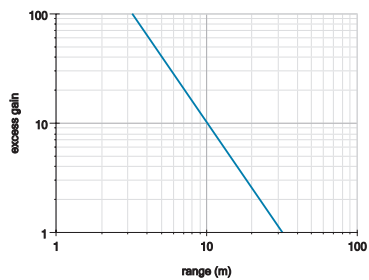

dimension drawings

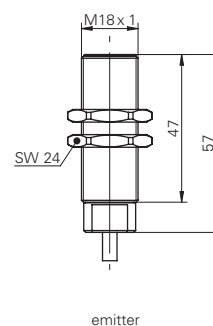
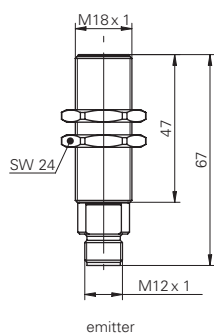
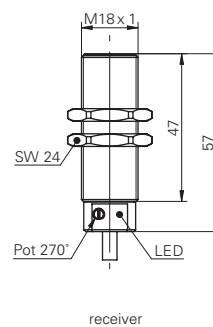
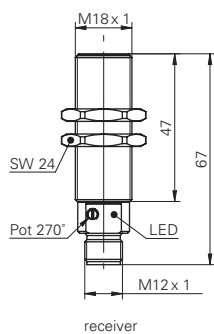

FSAM 18 / FEAM 18 Sb = 16 m

Through beam sensors

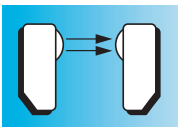

S_b = 6 m

- cross-technology housing concept
- small mounting depth
- test input



general data

| | |
|------------------------------|---------------------|
| type | through beam sensor |
| actual range S _b | 6 m |
| nominal range S _n | 8 m |

receiver

| | |
|-----------------------------------|--------------------------|
| alignment / soiled lens indicator | flashing light indicator |
| light indicator | LED yellow |
| sensitivity adjustment | Pot, 270° |

emitter

| | |
|--------------|----------------|
| light source | pulsed red LED |
| wave length | 660 nm |

electrical data

| | |
|-----------------------------|---------------|
| voltage supply range +Vs | 10 ... 30 VDC |
| reverse polarity protection | yes |

receiver

| | |
|------------------------------|----------------------|
| response time / release time | < 0,5 ms |
| current consumption max. | 20 mA |
| current consumption typ. | 20 mA |
| voltage drop V _d | < 1,8 VDC |
| output function | light / dark operate |
| output current | < 100 mA |
| short circuit protection | yes |

emitter

| | |
|--------------------------|-------|
| current consumption max. | 25 mA |
| current consumption typ. | 22 mA |

mechanical data

| | |
|------------------|---------------------|
| width / diameter | 20 mm |
| height / length | 42 mm |
| depth | 15 mm |
| type | rectangular |
| housing material | plastic (PBT-ASA) |
| front (optics) | PMMA |
| connection types | connector M8, 4 pin |

ambient conditions

| | |
|-----------------------|----------------|
| operating temperature | -25 ... +65 °C |
| protection class | IP 67 |

connection diagrams

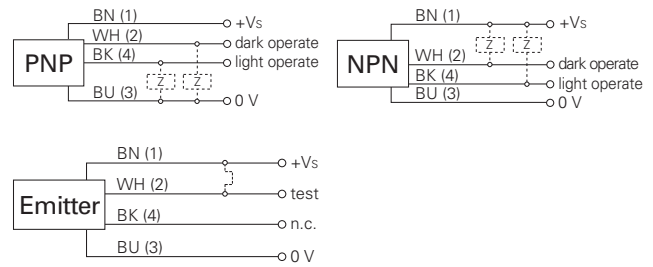

connectors

| | | |
|--------------|-------|--------------|
| ESG 32AH0200 | 4 pin | 2 m straight |
| ESW 31AH0200 | 4 pin | 2 m angular |

additional cable connectors and field wireable connectors, see accessories

accessories

| | |
|-----------------------|--------|
| SENSOFIX mounting kit | 150326 |
|-----------------------|--------|

for details, see accessories section

| order reference | emitter / receiver | output circuit |
|-------------------|--------------------|----------------|
| FEDK 20N5101/S35A | receiver | NPN |
| FEDK 20P5101/S35A | receiver | PNP |
| FSDK 20D9601/S35A | emitter | - |

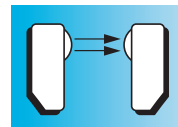

excess gain curve

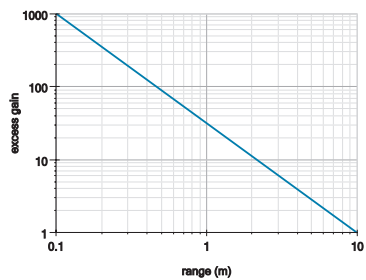

dimension drawings

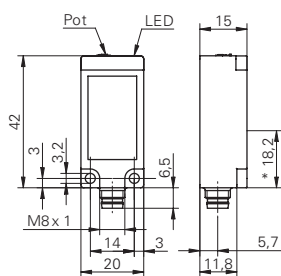

* receiver axis

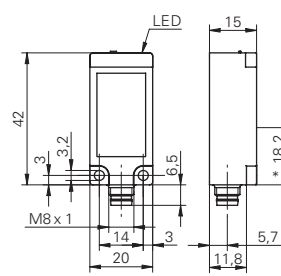

* emitter axis

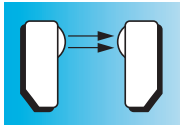
S_b = 20 m

- long range

**general data**

| | |
|------------------------------|---------------------|
| type | through beam sensor |
| actual range S _b | 20 m |
| nominal range S _n | 25 m |

receiver

| | |
|-----------------------------------|--------------------------|
| alignment / soiled lens indicator | flashing light indicator |
| light indicator | LED yellow |
| sensitivity adjustment | no |

emitter

| | |
|--------------|-----------------------|
| light source | pulsed infrared diode |
| wave length | 880 nm |

electrical data

| | |
|-----------------------------|---------------|
| voltage supply range +Vs | 10 ... 30 VDC |
| reverse polarity protection | yes |

receiver

| | |
|------------------------------|----------------------|
| response time / release time | < 1 ms |
| current consumption max. | 20 mA |
| current consumption typ. | 20 mA |
| voltage drop V _d | < 1,8 VDC |
| output function | light / dark operate |
| output circuit | PNP |
| output current | < 200 mA |
| short circuit protection | yes |

emitter

| | |
|--------------------------|-------|
| current consumption max. | 38 mA |
| current consumption typ. | 28 mA |

mechanical data

| | |
|------------------|----------------------|
| width / diameter | 25 mm |
| height / length | 80 mm |
| depth | 58 mm |
| type | rectangular |
| housing material | plastic (ASA) |
| front (optics) | PMMA |
| connection types | connector M12, 4 pin |

ambient conditions

| | |
|-----------------------|----------------|
| operating temperature | -25 ... +65 °C |
| protection class | IP 67 |

order reference**emitter / receiver**

| | |
|------------------|----------|
| FEDK 26P5103/S14 | receiver |
| FSDK 26D9003/S14 | emitter |

connection diagrams**connectors**

| | | |
|--------------|-------|--------------|
| ESG 34AH0200 | 4 pin | 2 m straight |
| ESW 33AH0200 | 4 pin | 2 m angular |

additional cable connectors and field wireable connectors, see accessories

accessories

| | |
|------------------|--------|
| mounting bracket | 112477 |
|------------------|--------|

for details, see accessories section

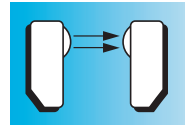



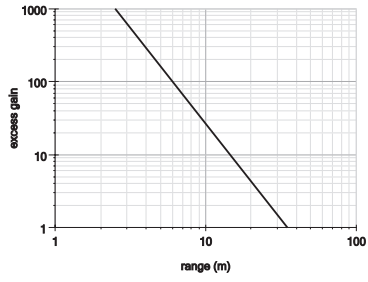

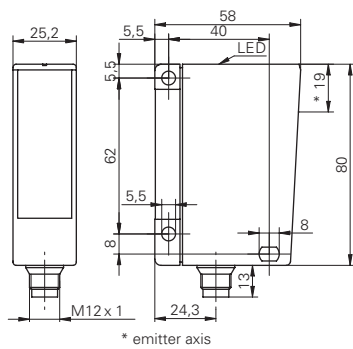

excess gain curve







dimension drawing









red light LED version

| product family | FGUM 030 | FGUM 050 | FGUM 080 | FGUM 020 | FGUM 030 | FGUM 050 | FGUM 080 |
|------------------------------|---|---|---|---|---|---|---|
| |  |  |  |  |  |  |  |
| width / diameter | 50 mm | 70 mm | 100 mm | 40 mm | 50 mm | 70 mm | 100 mm |
| fork width Sb | 30 mm | 50 mm | 80 mm | 20 mm | 30 mm | 50 mm | 80 mm |
| response time / release time | < 0,166 ms | < 0,166 ms | < 0,166 ms | < 0,125 ms | < 0,125 ms | < 0,125 ms | < 0,125 ms |
| sensitivity adjustment | Teach-in: button / remote | Teach-in: button / remote | Teach-in: button / remote | Pot, 270° | Pot, 270° | Pot, 270° | Pot, 270° |
| PNP | ■ | ■ | ■ | ■ | ■ | ■ | ■ |
| cable | | | | | | | |
| connector | ■ | ■ | ■ | ■ | ■ | ■ | ■ |
| housing material | metal | metal | metal | metal | metal | metal | metal |
| | | | | | | | |
| Page | 427 | 428 | 429 | 430 | 431 | 432 | 433 |

laser version

| product family | OGUM 030 | OGUM 050 | OGUM 080 | OGUM 120 |
|------------------------------|---|---|---|--|
| |  |  |  |  |
| width / diameter | 60 mm | 80 mm | 110 mm | 150 mm |
| fork width Sb | 30 mm | 50 mm | 80 mm | 120 mm |
| response time / release time | < 0,166 ms | < 0,166 ms | < 0,166 ms | < 0,166 ms |
| sensitivity adjustment | Pot, 270° | Pot, 270° | Pot, 270° | Pot, 270° |
| PNP | ■ | ■ | ■ | ■ |
| connector | ■ | ■ | ■ | ■ |
| housing material | metal | metal | metal | metal |
| | | | | |
| Page | 435 | 436 | 437 | 438 |

| FGUM 120 | FGLM 050 | FGLM 080 | FGLM 120 | FEG 12 | FGDK 28 | FEG 14 |
|---|---|---|---|---|---|---|
|  |  |  |  |  |  |  |
| 144 mm | 75 mm | 105 mm | 150 mm | 12 mm | 28 mm | 14 mm |
| 120 mm | 60 mm | 100 mm | 158 mm | 3 mm | 2,7 mm | 3 mm |
| < 0,25 ms | < 0,125 ms | < 0,125 ms | < 0,25 ms | < 0,01 ms | < 0,01 ms | < 0,01 ms |
| Pot, 270° | Pot, 270° | Pot, 270° | Pot, 270° | no | no | no |
| ■ | ■ | ■ | ■ | ■ | ■ | ■ |
| | | | | ■ | ■ | ■ |
| ■ | ■ | ■ | ■ | | | |
| metal | metal | metal | metal | metal | plastic | metal |
| | | | | | | |
| 434 | 439 | 440 | 441 | 442 | 443 | 444 |



Fork and angle sensors consist of an emitter and a receiver which are already optimally aligned to each other and installed in a torsionally rigid metal housing. This permits highly accurate detection and positioning of objects, as is demanded in automatic feeders, vibration conveyors and other applications. The precision collimator optics ensure high repeatability. Equipped with a laser light source, fork sensors can even position the smallest parts in the micron range. Time-consuming alignment and adjustment as is usual with through beam sensors is unnecessary. In contrast with through beam sensors, the wiring is also limited to just one cable connection.

Typical applications

Due to their simple handling and the optimally aligned optics, fork and angle sensors are highly versatile in use. To achieve the best possible installation, different fork spans as well as U and L-shaped versions are available.

Detection and positioning

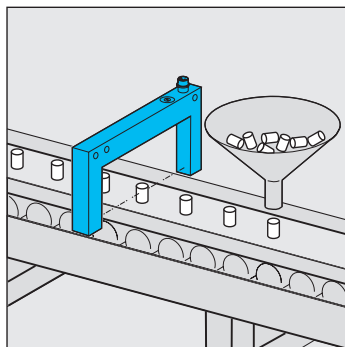

Detection of very small objects down to 50 μm in an automatic feeder

Stack height monitoring

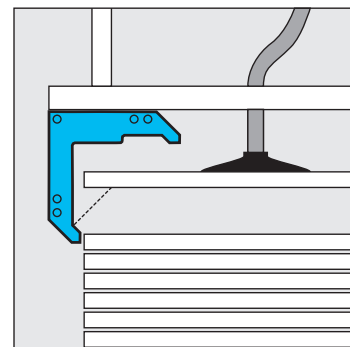

Monitoring stack heights of cardboard sheets

Angular speed monitoring

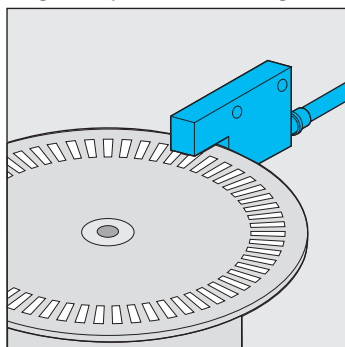

Angular speed monitoring of shafts using pulse disks



Characteristics and advantages

Little installation and adjustment work

The emitter and receiver are already optimally aligned to each other in a torsionally rigid metal housing.

Innovative shapes

The special L-shape of the angle sensor permits an optimum approach to the optical axis.

Fast processes

Switching frequencies of up to 50 kHz permit angular speed measurement.

Rugged

Use also in harsh ambient conditions due to metal housing and protection class IP 67.

Technology and operation

The fundamental principle of the fork and angle sensors is equivalent to the through beam sensors.

The scratch-resistant, mineral glass collimator optics used in the fork and angle sensors FGUM/FGLM and OGUM produces a homogenous, very narrow light beam. This feature is the reason for the high detection accuracy of the sensor, which is guaranteed over the entire beam range from all sides. The largest laser fork sensor can reliably and repeatably detect an object 50 µm small over the entire range of 120 mm.

The almost parallel light beam and the small beam angle of the receiver optics makes it possible to install the fork and angle sensors closely adjacent to each other without interfering with each other. In this way, it is possible to implement small light barriers.

For sensitivity adjustment, there is an option between two different adjustment methods – simple manual adjustment of the sensitivity using a potentiometer or variable adjustment facilities by automatic teach-in.

Potentiometer

Simple sensitivity adjustment with mechanical 270° potentiometer directly on the fork sensor.

Teach-In

Rapid and simple commissioning in practical use is possible using the teach-in function. Programming can be conducted either with the integrated Teach-in button or via the external Teach-in cable.



Mounting and adjustment

The almost parallel light beam and the small beam angle of the receiver optics makes it possible to install the fork and angle sensors closely adjacent to each other without interfering with each other. In this way, it is possible to construct small light barriers. Attach the fork / angle sensors so that the object can pass freely through the monitored area. External light impinging directly at the receiver side should be avoided.

Potentiometer adjustment

The sensitivity is highest when the potentiometer is turned fully counter clockwise. The smallest possible parts are thereby detected. The power of the beam is then smallest. When the potentiometer is turned fully clockwise, the sensitivity is lowest. Only larger parts are detected. The power of the beam is highest and the fork / angle sensor has a high excess gain to combat dirt.

Teach-in adjustment

With the dynamic Teach-in, the sensor is able to calculate the optimum sensitivity in the running process. This makes completely new applications possible. For example, the smallest objects can be taught in without precise positioning simply by passing the light beam.

To initiate the dynamic Teach-in procedure, the yellow Teach-in button must be held depressed for 2 seconds. At least two objects should pass the light beam of the fork sensor in the following 2-4 seconds of the active Teach-in phase. The LED indicates the active Teach-in phase by rapid flashing. When the Teach-in procedure has been completed successfully, this is made clearly visible by two flashes of the LED.

The active Teach-in phase can be determined individually by an external Teach-in facility. The longer a pulse is applied to the external Teach-in cable, the longer the sensor learns of its surroundings. When the external Teach-in facility is employed, the Teach-in button can also be automatically disabled.

Adjustment of light/dark switching

The output functions NO (dark-switching) and NC (light-switching) can be adjusted using a rotary switch. The required switch position can be seen from the type plate. To prevent unintended switching, the rotary switch is covered by a rubber cap.

Important: always set the switch for the output function fully clockwise or counter clockwise. Intermediate positions lead to undefined output states.

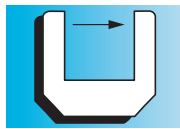

Sb = 30 mm



- fast version available
- smallest detectable object 0,8 mm
- rugged metal housing

general data

| | |
|------------------------|---------------------------|
| type | through beam sensor |
| object size | > 0,3 mm |
| repeatability | < 0,03 mm |
| hysteresis | < 0,1 mm |
| ambient light immunity | 20 kLux |
| sensitivity adjustment | Teach-in: button / remote |
| light source | pulsed red LED |
| wave length | 660 nm |
| light indicator | LED yellow |

electrical data

| | |
|------------------------------|---------------------------------|
| response time / release time | < 0,166 ms |
| switching frequency | < 3 kHz |
| voltage supply range +Vs | 10 ... 35 VDC |
| current consumption max. | 30 mA |
| output function | light / dark operate switchable |
| output circuit | PNP |
| voltage drop Vd | < 2 VDC |
| output current | < 200 mA |
| short circuit protection | yes |
| reverse polarity protection | yes |

mechanical data

| | |
|-------------------|---------------|
| width / diameter | 50 mm |
| fork width Sb | 30 mm |
| height / length | 60 mm |
| penetration depth | 35 mm |
| depth | 10 mm |
| type | U profile |
| housing material | die-cast zinc |
| connection types | connector M8 |

ambient conditions

| | |
|-----------------------|----------------|
| operating temperature | -10 ... +60 °C |
| protection class | IP 67 |

connectors

| | | |
|--------------|-------|--------------|
| ESG 32AH0200 | 4 pin | 2 m straight |
| ESW 31AH0200 | 4 pin | 2 m angular |

additional cable connectors and field wireable connectors, see accessories

order reference

FGUM 030P6901/S35A

dimension drawing

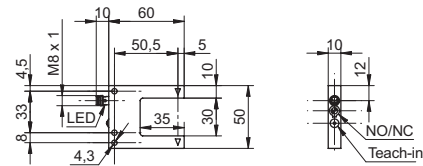

connection diagram



FGUM 030 Sb = 30 mm

Fork and angle sensors

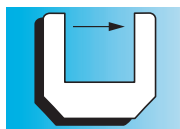

Sb = 50 mm



- fast version available
- smallest detectable object 0,8 mm
- rugged metal housing

general data

| | |
|------------------------|---------------------------|
| type | through beam sensor |
| object size | > 0,3 mm |
| repeatability | < 0,03 mm |
| hysteresis | < 0,1 mm |
| ambient light immunity | 20 kLux |
| sensitivity adjustment | Teach-in: button / remote |
| light source | pulsed red LED |
| wave length | 660 nm |
| light indicator | LED yellow |

electrical data

| | |
|------------------------------|---------------------------------|
| response time / release time | < 0,166 ms |
| switching frequency | < 3 kHz |
| voltage supply range +Vs | 10 ... 35 VDC |
| current consumption max. | 30 mA |
| output function | light / dark operate switchable |
| output circuit | PNP |
| voltage drop Vd | < 2 VDC |
| output current | < 200 mA |
| short circuit protection | yes |
| reverse polarity protection | yes |

mechanical data

| | |
|-------------------|---------------|
| width / diameter | 70 mm |
| fork width Sb | 50 mm |
| height / length | 80 mm |
| penetration depth | 55 mm |
| depth | 10 mm |
| type | U profile |
| housing material | die-cast zinc |
| connection types | connector M8 |

ambient conditions

| | |
|-----------------------|----------------|
| operating temperature | -10 ... +60 °C |
| protection class | IP 67 |

connectors

| | | |
|--------------|-------|--------------|
| ESG 32AH0200 | 4 pin | 2 m straight |
| ESW 31AH0200 | 4 pin | 2 m angular |

additional cable connectors and field wireable connectors, see accessories

order reference

FGUM 050P6901/S35A

dimension drawing

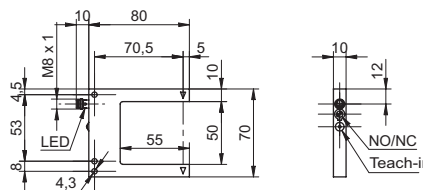

connection diagram



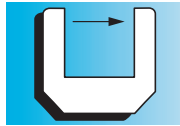

Sb = 80 mm



- fast version available
- smallest detectable object 0,8 mm
- rugged metal housing

general data

| | |
|------------------------|---------------------------|
| type | through beam sensor |
| object size | > 0,3 mm |
| repeatability | < 0,03 mm |
| hysteresis | < 0,1 mm |
| ambient light immunity | 20 kLux |
| sensitivity adjustment | Teach-in: button / remote |
| light source | pulsed red LED |
| wave length | 660 nm |
| light indicator | LED yellow |

electrical data

| | |
|------------------------------|---------------------------------|
| response time / release time | < 0,166 ms |
| switching frequency | < 3 kHz |
| voltage supply range +Vs | 10 ... 35 VDC |
| current consumption max. | 30 mA |
| output function | light / dark operate switchable |
| output circuit | PNP |
| voltage drop Vd | < 2 VDC |
| output current | < 200 mA |
| short circuit protection | yes |
| reverse polarity protection | yes |

mechanical data

| | |
|-------------------|---------------|
| width / diameter | 100 mm |
| fork width Sb | 80 mm |
| height / length | 80 mm |
| penetration depth | 55 mm |
| depth | 10 mm |
| type | U profile |
| housing material | die-cast zinc |
| connection types | connector M8 |

ambient conditions

| | |
|-----------------------|----------------|
| operating temperature | -10 ... +60 °C |
| protection class | IP 67 |

connectors

| | | |
|--------------|-------|--------------|
| ESG 32AH0200 | 4 pin | 2 m straight |
| ESW 31AH0200 | 4 pin | 2 m angular |

additional cable connectors and field wireable connectors, see accessories

order reference

FGUM 080P6901/S35A

dimension drawing

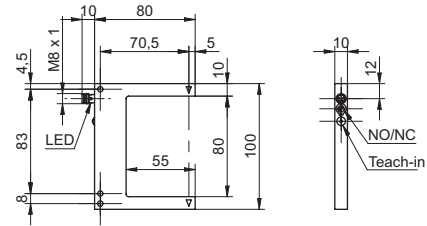

connection diagram

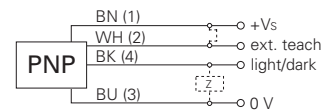

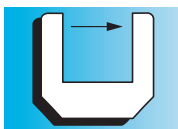

Sb = 20 mm



- sensitivity adjustable via potentiometer
- fork width 20 mm
- rugged metal housing

general data

| | |
|------------------------|---------------------|
| type | through beam sensor |
| object size | > 0,4 mm |
| repeatability | < 0,02 mm |
| hysteresis | < 0,1 mm |
| ambient light immunity | 50 kLux |
| sensitivity adjustment | Pot, 270° |
| light source | pulsed red LED |
| wave length | 660 nm |
| light indicator | LED yellow |

electrical data

| | |
|------------------------------|---------------------------------|
| response time / release time | < 0,125 ms |
| switching frequency | < 4 kHz |
| voltage supply range +Vs | 10 ... 35 VDC |
| current consumption max. | 30 mA |
| output function | light / dark operate switchable |
| output circuit | PNP |
| voltage drop Vd | < 2,8 VDC |
| output current | < 200 mA |
| short circuit protection | yes |
| reverse polarity protection | yes |

mechanical data

| | |
|-------------------|---------------------|
| width / diameter | 40 mm |
| fork width Sb | 20 mm |
| height / length | 50 mm |
| penetration depth | 25 mm |
| depth | 10 mm |
| type | U profile |
| housing material | die-cast zinc |
| connection types | connector M8, 3 pin |

ambient conditions

| | |
|-----------------------|----------------|
| operating temperature | -10 ... +60 °C |
| protection class | IP 67 |

connectors

| | | |
|--------------|-------|--------------|
| ESG 32SH0200 | 3 pin | 2 m straight |
| ESW 31SH0200 | 3 pin | 2 m angular |

additional cable connectors and field wireable connectors, see accessories

accessories

| | |
|----------------------|--------|
| PNP to NPN-converter | 149587 |
|----------------------|--------|

for details, see accessories section

dimension drawing

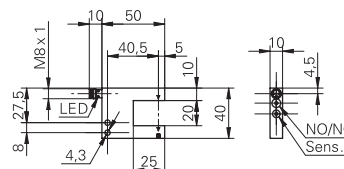

connection diagram

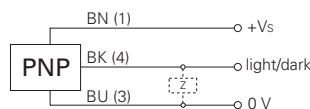

FGUM 020 Sb = 20 mm

Fork and angle sensors

order reference

FGUM 020P8001/S35L

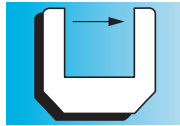

Sb = 30 mm



- sensitivity adjustable via potentiometer
- fork width 30 mm
- rugged metal housing

general data

| | |
|------------------------|---------------------|
| type | through beam sensor |
| object size | > 0,5 mm |
| repeatability | < 0,02 mm |
| hysteresis | < 0,25 mm |
| ambient light immunity | 140 kLux |
| sensitivity adjustment | Pot, 270° |
| light source | pulsed red LED |
| wave length | 660 nm |
| light indicator | LED yellow |

electrical data

| | |
|------------------------------|---------------------------------|
| response time / release time | < 0,125 ms |
| switching frequency | < 4 kHz |
| voltage supply range +Vs | 10 ... 35 VDC |
| current consumption max. | 30 mA |
| output function | light / dark operate switchable |
| output circuit | PNP |
| voltage drop Vd | < 2,8 VDC |
| output current | < 200 mA |
| short circuit protection | yes |
| reverse polarity protection | yes |

mechanical data

| | |
|-------------------|---------------------|
| width / diameter | 50 mm |
| fork width Sb | 30 mm |
| height / length | 60 mm |
| penetration depth | 35 mm |
| depth | 10 mm |
| type | U profile |
| housing material | die-cast zinc |
| connection types | connector M8, 3 pin |

ambient conditions

| | |
|-----------------------|----------------|
| operating temperature | -10 ... +60 °C |
| protection class | IP 67 |

connectors

| | | |
|--------------|-------|--------------|
| ESG 32SH0200 | 3 pin | 2 m straight |
| ESW 31SH0200 | 3 pin | 2 m angular |

additional cable connectors and field wireable connectors, see accessories

order reference

FGUM 030P8001/S35L

dimension drawing

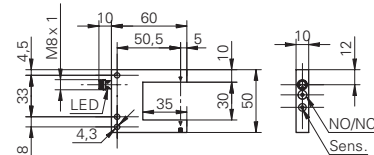

connection diagram

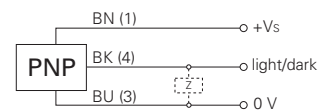

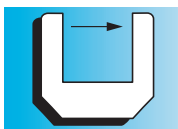

Sb = 50 mm



- sensitivity adjustable via potentiometer
- fork width 50 mm
- rugged metal housing

general data

| | |
|------------------------|---------------------|
| type | through beam sensor |
| object size | > 0,5 mm |
| repeatability | < 0,04 mm |
| hysteresis | < 0,25 mm |
| ambient light immunity | 80 kLux |
| sensitivity adjustment | Pot, 270° |
| light source | pulsed red LED |
| wave length | 660 nm |
| light indicator | LED yellow |

electrical data

| | |
|------------------------------|---------------------------------|
| response time / release time | < 0,125 ms |
| switching frequency | < 4 kHz |
| voltage supply range +Vs | 10 ... 35 VDC |
| current consumption max. | 30 mA |
| output function | light / dark operate switchable |
| output circuit | PNP |
| voltage drop Vd | < 2,8 VDC |
| output current | < 200 mA |
| short circuit protection | yes |
| reverse polarity protection | yes |

mechanical data

| | |
|-------------------|---------------------|
| width / diameter | 70 mm |
| fork width Sb | 50 mm |
| height / length | 80 mm |
| penetration depth | 55 mm |
| depth | 10 mm |
| type | U profile |
| housing material | die-cast zinc |
| connection types | connector M8, 3 pin |

ambient conditions

| | |
|-----------------------|----------------|
| operating temperature | -10 ... +60 °C |
| protection class | IP 67 |

connectors

| | | |
|--------------|-------|--------------|
| ESG 32SH0200 | 3 pin | 2 m straight |
| ESW 31SH0200 | 3 pin | 2 m angular |

additional cable connectors and field wireable connectors, see accessories

order reference

FGUM 050P8001/S35L

dimension drawing

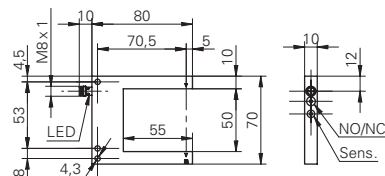

connection diagram

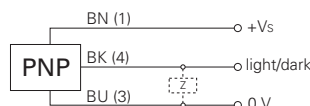

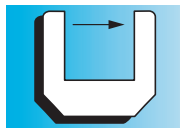

Sb = 80 mm

- sensitivity adjustable via potentiometer
- fork width 80 mm
- rugged metal housing



general data

| | |
|------------------------|---------------------|
| type | through beam sensor |
| object size | > 0,5 mm |
| repeatability | < 0,06 mm |
| hysteresis | < 0,25 mm |
| ambient light immunity | 80 kLux |
| sensitivity adjustment | Pot, 270° |
| light source | pulsed red LED |
| wave length | 660 nm |
| light indicator | LED yellow |

electrical data

| | |
|------------------------------|---------------------------------|
| response time / release time | < 0,125 ms |
| switching frequency | < 4 kHz |
| voltage supply range +Vs | 10 ... 35 VDC |
| current consumption max. | 30 mA |
| output function | light / dark operate switchable |
| output circuit | PNP |
| voltage drop Vd | < 2,8 VDC |
| output current | < 200 mA |
| short circuit protection | yes |
| reverse polarity protection | yes |

mechanical data

| | |
|-------------------|---------------------|
| width / diameter | 100 mm |
| fork width Sb | 80 mm |
| height / length | 80 mm |
| penetration depth | 55 mm |
| depth | 10 mm |
| type | U profile |
| housing material | die-cast zinc |
| connection types | connector M8, 3 pin |

ambient conditions

| | |
|-----------------------|----------------|
| operating temperature | -10 ... +60 °C |
| protection class | IP 67 |

connectors

| | | |
|--------------|-------|--------------|
| ESG 32SH0200 | 3 pin | 2 m straight |
| ESW 31SH0200 | 3 pin | 2 m angular |

additional cable connectors and field wireable connectors, see accessories

order reference

FGUM 080P8001/S35L

dimension drawing

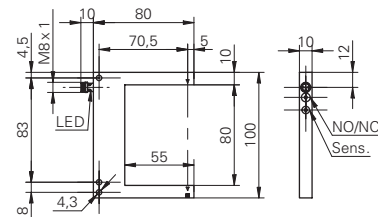

connection diagram

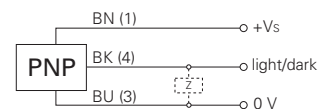

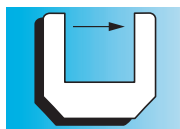

Sb = 120 mm



- sensitivity adjustable via potentiometer
- fork width 120 mm
- rugged metal housing

general data

| | |
|------------------------|---------------------|
| type | through beam sensor |
| object size | > 0,8 mm |
| repeatability | < 0,06 mm |
| hysteresis | < 0,25 mm |
| ambient light immunity | 50 kLux |
| sensitivity adjustment | Pot, 270° |
| light source | pulsed red LED |
| wave length | 660 nm |
| light indicator | LED yellow |

electrical data

| | |
|------------------------------|---------------------------------|
| response time / release time | < 0,25 ms |
| switching frequency | < 2 kHz |
| voltage supply range +Vs | 10 ... 35 VDC |
| current consumption max. | 40 mA |
| output function | light / dark operate switchable |
| output circuit | PNP |
| voltage drop Vd | < 2,8 VDC |
| output current | < 200 mA |
| short circuit protection | yes |
| reverse polarity protection | yes |

mechanical data

| | |
|-------------------|---------------------|
| width / diameter | 144 mm |
| fork width Sb | 120 mm |
| height / length | 90 mm |
| penetration depth | 60 mm |
| depth | 12 mm |
| type | U profile |
| housing material | die-cast zinc |
| connection types | connector M8, 3 pin |

ambient conditions

| | |
|-----------------------|----------------|
| operating temperature | -10 ... +60 °C |
| protection class | IP 67 |

connectors

| | | |
|--------------|-------|--------------|
| ESG 32SH0200 | 3 pin | 2 m straight |
| ESW 31SH0200 | 3 pin | 2 m angular |

additional cable connectors and field wireable connectors, see accessories

accessories

| | |
|----------------------|--------|
| PNP to NPN-converter | 149587 |
|----------------------|--------|

for details, see accessories section

dimension drawing

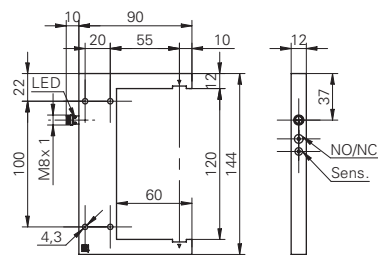

connection diagram

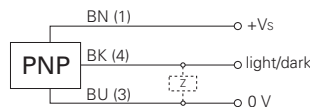

order reference

FGUM 120P8001/S35L

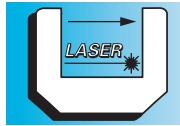

Sb = 30 mm

- precise laser fork sensor in rugged metal housing
- smallest detectable object 0.05 mm
- high repeatability



general data

| | |
|------------------------|------------------------|
| type | through beam sensor |
| object size | > 0,05 mm |
| repeatability | < 0,01 mm |
| hysteresis | < 0,02 mm |
| ambient light immunity | 100 kLux |
| sensitivity adjustment | Pot, 270° |
| light source | pulsed red laser diode |
| wave length | 670 nm |
| laser class | 2 |
| light indicator | LED yellow |

electrical data

| | |
|------------------------------|---------------------------------|
| response time / release time | < 0,166 ms |
| switching frequency | < 3 kHz |
| voltage supply range +Vs | 10 ... 30 VDC |
| current consumption max. | 30 mA |
| output function | light / dark operate switchable |
| output circuit | PNP |
| voltage drop Vd | < 2,8 VDC |
| output current | < 200 mA |
| short circuit protection | yes |
| reverse polarity protection | yes |

mechanical data

| | |
|-------------------|---------------------|
| width / diameter | 60 mm |
| fork width Sb | 30 mm |
| height / length | 60 mm |
| penetration depth | 35 mm |
| depth | 10 mm |
| type | U profile |
| housing material | aluminum anodized |
| connection types | connector M8, 3 pin |

ambient conditions

| | |
|-----------------------|--------------|
| operating temperature | 5 ... +45 °C |
| protection class | IP 67 |

connectors

| | | |
|--------------|-------|--------------|
| ESG 32SH0200 | 3 pin | 2 m straight |
| ESW 31SH0200 | 3 pin | 2 m angular |

additional cable connectors and field wireable connectors, see accessories

accessories

| | |
|----------------------|--------|
| PNP to NPN-converter | 149587 |
|----------------------|--------|

for details, see accessories section

order reference

OGUM 030P8001/S35L

dimension drawing

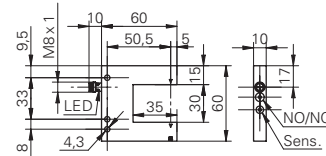

connection diagram

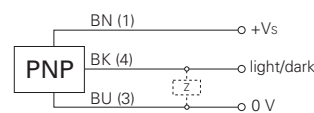

laser warning

CAUTION

LASER RADIATION

DO NOT STARE INTO BEAM

LASERDIODE

Wavelength: 630 - 680 nm
Max. Output: < 1 mW
Complies with EN60825-1:2001

Class 2 LASER Product

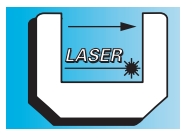

Sb = 50 mm



- precise laser fork sensor in rugged metal housing
- smallest detectable object 0,05 mm
- high repeatability

general data

| | |
|------------------------|------------------------|
| type | through beam sensor |
| object size | > 0,05 mm |
| repeatability | < 0,01 mm |
| hysteresis | < 0,02 mm |
| ambient light immunity | 100 kLux |
| sensitivity adjustment | Pot, 270° |
| light source | pulsed red laser diode |
| wave length | 670 nm |
| laser class | 2 |
| light indicator | LED yellow |

electrical data

| | |
|------------------------------|---------------------------------|
| response time / release time | < 0,166 ms |
| switching frequency | < 3 kHz |
| voltage supply range +Vs | 10 ... 30 VDC |
| current consumption max. | 30 mA |
| output function | light / dark operate switchable |
| output circuit | PNP |
| voltage drop Vd | < 2,8 VDC |
| output current | < 200 mA |
| short circuit protection | yes |
| reverse polarity protection | yes |

mechanical data

| | |
|-------------------|---------------------|
| width / diameter | 80 mm |
| fork width Sb | 50 mm |
| height / length | 80 mm |
| penetration depth | 55 mm |
| depth | 10 mm |
| type | U profile |
| housing material | aluminum anodized |
| connection types | connector M8, 3 pin |

ambient conditions

| | |
|-----------------------|--------------|
| operating temperature | 5 ... +45 °C |
| protection class | IP 67 |

connectors

| | | |
|--------------|-------|--------------|
| ESG 32SH0200 | 3 pin | 2 m straight |
| ESW 31SH0200 | 3 pin | 2 m angular |

additional cable connectors and field wireable connectors, see accessories

accessories

| | |
|----------------------|--------|
| PNP to NPN-converter | 149587 |
|----------------------|--------|

for details, see accessories section

dimension drawing

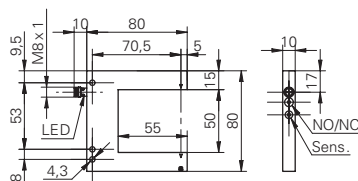

connection diagram

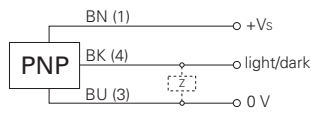

laser warning

CAUTION

LASER RADIATION

DO NOT STARE
INTO BEAM

LASERDIODE

Wavelength: 630 - 680 nm
Max. Output: < 1 mW
Complies with EN60825-1:2001

Class 2 LASER Product

order reference

OGUM 050P8001/S35L

OGUM 050 Sb = 50 mm Fork and angle sensors

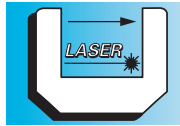

Sb = 80 mm

- precise laser fork sensor in rugged metal housing
- smallest detectable object 0,05 mm
- high repeatability



general data

| | |
|------------------------|------------------------|
| type | through beam sensor |
| object size | > 0,05 mm |
| repeatability | < 0,01 mm |
| hysteresis | < 0,02 mm |
| ambient light immunity | 100 kLux |
| sensitivity adjustment | Pot, 270° |
| light source | pulsed red laser diode |
| wave length | 670 nm |
| laser class | 2 |
| light indicator | LED yellow |

electrical data

| | |
|------------------------------|---------------------------------|
| response time / release time | < 0,166 ms |
| switching frequency | < 3 kHz |
| voltage supply range +Vs | 10 ... 30 VDC |
| current consumption max. | 30 mA |
| output function | light / dark operate switchable |
| output circuit | PNP |
| voltage drop Vd | < 2,8 VDC |
| output current | < 200 mA |
| short circuit protection | yes |
| reverse polarity protection | yes |

mechanical data

| | |
|-------------------|---------------------|
| width / diameter | 110 mm |
| fork width Sb | 80 mm |
| height / length | 80 mm |
| penetration depth | 55 mm |
| depth | 10 mm |
| type | U profile |
| housing material | aluminum anodized |
| connection types | connector M8, 3 pin |

ambient conditions

| | |
|-----------------------|--------------|
| operating temperature | 5 ... +45 °C |
| protection class | IP 67 |

connectors

| | | |
|--------------|-------|--------------|
| ESG 32SH0200 | 3 pin | 2 m straight |
| ESW 31SH0200 | 3 pin | 2 m angular |

additional cable connectors and field wireable connectors, see accessories

accessories

| | |
|----------------------|--------|
| PNP to NPN-converter | 149587 |
|----------------------|--------|

for details, see accessories section

order reference

OGUM 080P8001/S35L

dimension drawing

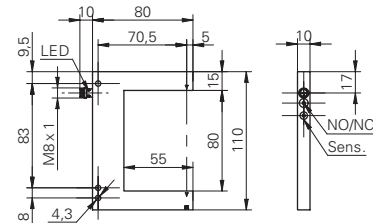

connection diagram

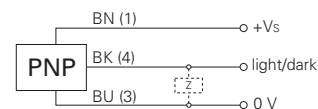

laser warning

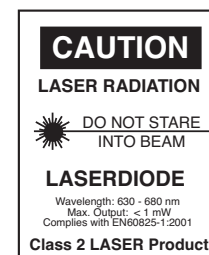

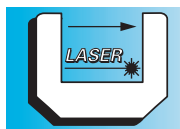

Sb = 120 mm

- precise laser fork sensor in rugged metal housing
- smallest detectable object 0,05 mm
- high repeatability



general data

| | |
|------------------------|------------------------|
| type | through beam sensor |
| object size | > 0,05 mm |
| repeatability | < 0,01 mm |
| hysteresis | < 0,02 mm |
| ambient light immunity | 100 kLux |
| sensitivity adjustment | Pot, 270° |
| light source | pulsed red laser diode |
| wave length | 670 nm |
| laser class | 2 |
| light indicator | LED yellow |

electrical data

| | |
|------------------------------|---------------------------------|
| response time / release time | < 0,166 ms |
| switching frequency | < 3 kHz |
| voltage supply range +Vs | 10 ... 30 VDC |
| current consumption max. | 30 mA |
| output function | light / dark operate switchable |
| output circuit | PNP |
| voltage drop Vd | < 2,8 VDC |
| output current | < 200 mA |
| short circuit protection | yes |
| reverse polarity protection | yes |

mechanical data

| | |
|-------------------|---------------------|
| width / diameter | 150 mm |
| fork width Sb | 120 mm |
| height / length | 90 mm |
| penetration depth | 60 mm |
| depth | 12 mm |
| type | U profile |
| housing material | aluminum anodized |
| connection types | connector M8, 3 pin |

ambient conditions

| | |
|-----------------------|--------------|
| operating temperature | 5 ... +45 °C |
| protection class | IP 67 |

connectors

| | | |
|--------------|-------|--------------|
| ESG 32SH0200 | 3 pin | 2 m straight |
| ESW 31SH0200 | 3 pin | 2 m angular |

additional cable connectors and field wireable connectors, see accessories

accessories

| | |
|----------------------|--------|
| PNP to NPN-converter | 149587 |
|----------------------|--------|

for details, see accessories section

dimension drawing

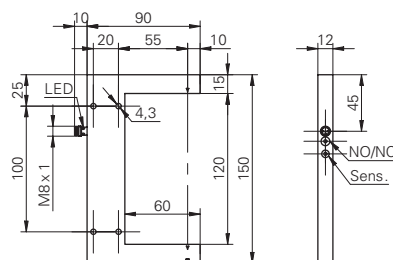

connection diagram

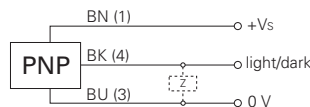

laser warning



OGUM 120 Sb = 120 mm

Fork and angle sensors

order reference

OGUM 120P8001/S35L

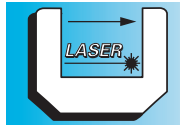

Sb = 60 mm



- optical axis approachable in x-, y- and z-direction
- smallest detectable object 0,5 mm
- rugged metal housing

general data

| | |
|------------------------|---------------------|
| type | through beam sensor |
| object size | > 0,5 mm |
| repeatability | < 0,06 mm |
| hysteresis | < 0,25 mm |
| ambient light immunity | 80 kLux |
| sensitivity adjustment | Pot, 270° |
| light source | pulsed red LED |
| wave length | 660 nm |
| light indicator | LED yellow |

electrical data

| | |
|------------------------------|---------------------------------|
| response time / release time | < 0,125 ms |
| switching frequency | < 4 kHz |
| voltage supply range +Vs | 10 ... 35 VDC |
| current consumption max. | 30 mA |
| output function | light / dark operate switchable |
| output circuit | PNP |
| voltage drop Vd | < 2,8 VDC |
| output current | < 200 mA |
| short circuit protection | yes |
| reverse polarity protection | yes |

mechanical data

| | |
|-------------------|---------------------|
| width / diameter | 75 mm |
| fork width Sb | 60 mm |
| height / length | 75 mm |
| penetration depth | 50 mm |
| depth | 10 mm |
| type | L profile |
| housing material | die-cast zinc |
| connection types | connector M8, 3 pin |

ambient conditions

| | |
|-----------------------|----------------|
| operating temperature | -10 ... +60 °C |
| protection class | IP 67 |

connectors

| | | |
|--------------|-------|--------------|
| ESG 32SH0200 | 3 pin | 2 m straight |
| ESW 31SH0200 | 3 pin | 2 m angular |

additional cable connectors and field wireable connectors, see accessories

accessories

| | |
|----------------------|--------|
| PNP to NPN-converter | 149587 |
|----------------------|--------|

for details, see accessories section

order reference

FGLM 050P8001/S35L

dimension drawing

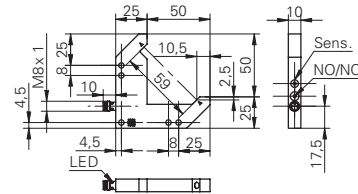

connection diagram

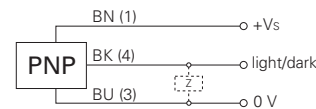

FGLM 050 Sb = 60 mm

Fork and angle sensors

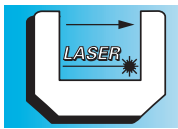

Sb = 100 mm



- optical axis approachable in x-, y- and z-direction
- smallest detectable object 0,07 mm
- rugged metal housing

general data

| | |
|------------------------|---------------------|
| type | through beam sensor |
| object size | > 0,7 mm |
| repeatability | < 0,06 mm |
| hysteresis | < 0,25 mm |
| ambient light immunity | 70 kLux |
| sensitivity adjustment | Pot, 270° |
| light source | pulsed red LED |
| wave length | 660 nm |
| light indicator | LED yellow |

electrical data

| | |
|------------------------------|---------------------------------|
| response time / release time | < 0,125 ms |
| switching frequency | < 4 kHz |
| voltage supply range +Vs | 10 ... 35 VDC |
| current consumption max. | 30 mA |
| output function | light / dark operate switchable |
| output circuit | PNP |
| voltage drop Vd | < 2,8 VDC |
| output current | < 200 mA |
| short circuit protection | yes |
| reverse polarity protection | yes |

mechanical data

| | |
|-------------------|---------------------|
| width / diameter | 105 mm |
| fork width Sb | 100 mm |
| height / length | 105 mm |
| penetration depth | 80 mm |
| depth | 10 mm |
| type | L profile |
| housing material | die-cast zinc |
| connection types | connector M8, 3 pin |

ambient conditions

| | |
|-----------------------|----------------|
| operating temperature | -10 ... +60 °C |
| protection class | IP 67 |

connectors

| | | |
|--------------|-------|--------------|
| ESG 32SH0200 | 3 pin | 2 m straight |
| ESW 31SH0200 | 3 pin | 2 m angular |

additional cable connectors and field wireable connectors, see accessories

accessories

| | |
|----------------------|--------|
| PNP to NPN-converter | 149587 |
|----------------------|--------|

for details, see accessories section

dimension drawing

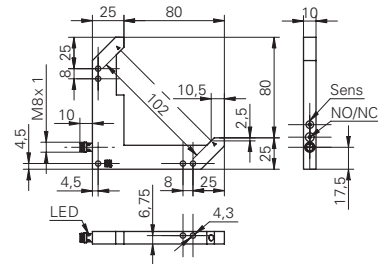

connection diagram

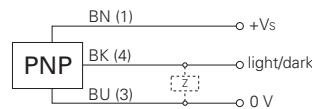

FGLM 080 Sb = 100 mm

Fork and angle sensors

order reference

FGLM 080P8001/S35L

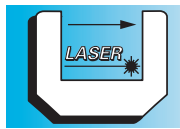

Sb = 158 mm



- optical axis approachable in x-, y- and z-direction
- smallest detectable object 1 mm
- rugged metal housing

general data

| | |
|------------------------|---------------------|
| type | through beam sensor |
| object size | > 1 mm |
| repeatability | < 0,06 mm |
| hysteresis | < 0,25 mm |
| ambient light immunity | 50 kLux |
| sensitivity adjustment | Pot, 270° |
| light source | pulsed red LED |
| wave length | 660 nm |
| light indicator | LED yellow |

electrical data

| | |
|------------------------------|---------------------------------|
| response time / release time | < 0,25 ms |
| switching frequency | < 2 kHz |
| voltage supply range +Vs | 10 ... 35 VDC |
| current consumption max. | 40 mA |
| output function | light / dark operate switchable |
| output circuit | PNP |
| voltage drop Vd | < 2,8 VDC |
| output current | < 200 mA |
| short circuit protection | yes |
| reverse polarity protection | yes |

mechanical data

| | |
|-------------------|---------------------|
| width / diameter | 150 mm |
| fork width Sb | 158 mm |
| height / length | 150 mm |
| penetration depth | 120 mm |
| depth | 12 mm |
| type | L profile |
| housing material | die-cast zinc |
| connection types | connector M8, 3 pin |

ambient conditions

| | |
|-----------------------|----------------|
| operating temperature | -10 ... +60 °C |
| protection class | IP 67 |

connectors

| | | |
|--------------|-------|--------------|
| ESG 32SH0200 | 3 pin | 2 m straight |
| ESW 31SH0200 | 3 pin | 2 m angular |

additional cable connectors and field wireable connectors, see accessories

accessories

| | |
|----------------------|--------|
| PNP to NPN-converter | 149587 |
|----------------------|--------|

for details, see accessories section

dimension drawing

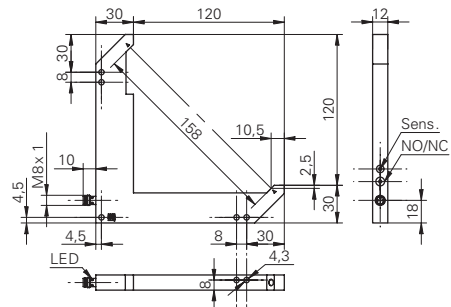

connection diagram

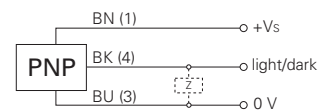

order reference

FGLM 120P8001/S35L

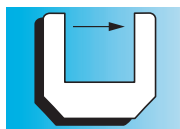

- 3 mm fork opening
- switching frequency up to 50 kHz
- smallest detectable object 0,8 mm



general data

| | |
|------------------------|---------------------------|
| type | through beam sensor |
| object size | > 0,8 mm |
| repeatability | < 0,01 mm |
| hysteresis | < 0,1 mm |
| sensitivity adjustment | no |
| light source | non-pulsed infrared diode |
| wave length | 935 nm |

electrical data

| | |
|------------------------------|----------------|
| response time / release time | < 0,01 ms |
| switching frequency | < 50 kHz |
| voltage supply range +Vs | 4,5 ... 30 VDC |
| current consumption max. | 24 mA |
| output circuit | PNP |
| voltage drop Vd | < 1 VDC |
| output current | < 100 mA |
| short circuit protection | no |
| reverse polarity protection | yes, Vs to GND |

mechanical data

| | |
|-------------------|---------------------|
| width / diameter | 12 mm |
| fork width Sb | 3 mm |
| height / length | 41 mm |
| penetration depth | 10 mm |
| depth | 25 mm |
| type | rectangular |
| housing material | brass nickel plated |
| connection types | cable 3 pin |

ambient conditions

| | |
|-----------------------|----------------|
| operating temperature | -25 ... +65 °C |
| protection class | IP 65 |

accessories

| | |
|--------------------------------------|--------|
| pulse disk | IPS 70 |
| for details, see accessories section | |

dimension drawing

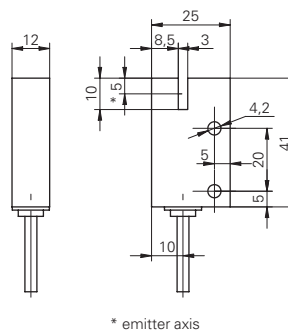

connection diagram

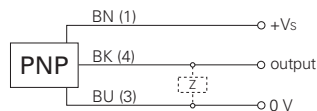

order reference output function

| | |
|---------------------|---------------|
| FEG 12.24.35 | dark operate |
| FEG 12.24.45 | light operate |

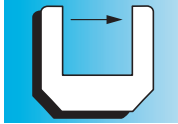

- 2,7 mm fork opening
- switching frequency up to 50 kHz
- smallest detectable object 0,8 mm



general data

| | |
|------------------------|---------------------------|
| type | through beam sensor |
| object size | > 0,8 mm |
| repeatability | < 0,01 mm |
| hysteresis | < 0,1 mm |
| sensitivity adjustment | no |
| light source | non-pulsed infrared diode |
| wave length | 935 nm |
| output indicator | LED yellow |

electrical data

| | |
|------------------------------|----------------|
| response time / release time | < 0,01 ms |
| switching frequency | < 50 kHz |
| voltage supply range +Vs | 4,5 ... 30 VDC |
| current consumption max. | 25 mA |
| output circuit | PNP |
| voltage drop Vd | < 1 VDC |
| output current | < 100 mA |
| short circuit protection | no |
| reverse polarity protection | yes, Vs to GND |

mechanical data

| | |
|-------------------|-------------|
| width / diameter | 28 mm |
| fork width Sb | 2,7 mm |
| height / length | 32 mm |
| penetration depth | 5 mm |
| depth | 15 mm |
| type | rectangular |
| housing material | polyamid |
| connection types | cable 3 pin |

ambient conditions

| | |
|-----------------------|--------------|
| operating temperature | 0 ... +65 °C |
| protection class | IP 65 |

accessories

| | |
|--------------------------------------|--------|
| pulse disk | IPS 70 |
| for details, see accessories section | |

order reference

| order reference | output function |
|-----------------|-----------------|
| FGDK 28P1001 | light operate |
| FGDK 28P3001 | dark operate |

dimension drawing

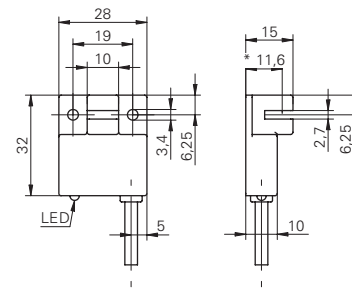

* emitter axis

connection diagram

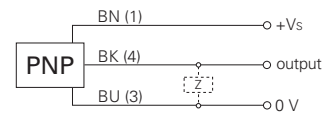

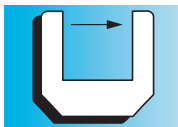

- 3 mm fork opening
- switching frequency up to 50 kHz
- smallest detectable object 0,8 mm



general data

| | |
|------------------------|---------------------------|
| type | through beam sensor |
| object size | > 0,8 mm |
| repeatability | < 0,01 mm |
| hysteresis | < 0,1 mm |
| sensitivity adjustment | no |
| light source | non-pulsed infrared diode |
| wave length | 935 nm |

electrical data

| | |
|------------------------------|----------------|
| response time / release time | < 0,01 ms |
| switching frequency | < 50 kHz |
| voltage supply range +Vs | 4,5 ... 30 VDC |
| current consumption max. | 24 mA |
| output function | dark operate |
| output circuit | PNP |
| voltage drop Vd | < 1 VDC |
| output current | < 100 mA |
| short circuit protection | no |
| reverse polarity protection | yes, Vs to GND |

mechanical data

| | |
|-------------------|---------------------|
| width / diameter | 14 mm |
| fork width Sb | 3 mm |
| height / length | 51 mm |
| penetration depth | 10 mm |
| type | cylindrical |
| housing material | brass nickel plated |
| connection types | cable 3 pin |

ambient conditions

| | |
|-----------------------|----------------|
| operating temperature | -25 ... +65 °C |
| protection class | IP 65 |

accessories

| | |
|--------------------------------------|--------|
| pulse disk | IPS 70 |
| for details, see accessories section | |

order reference

FEG 14.24.35

dimension drawing

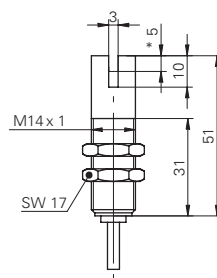

* emitter axis



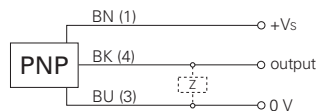

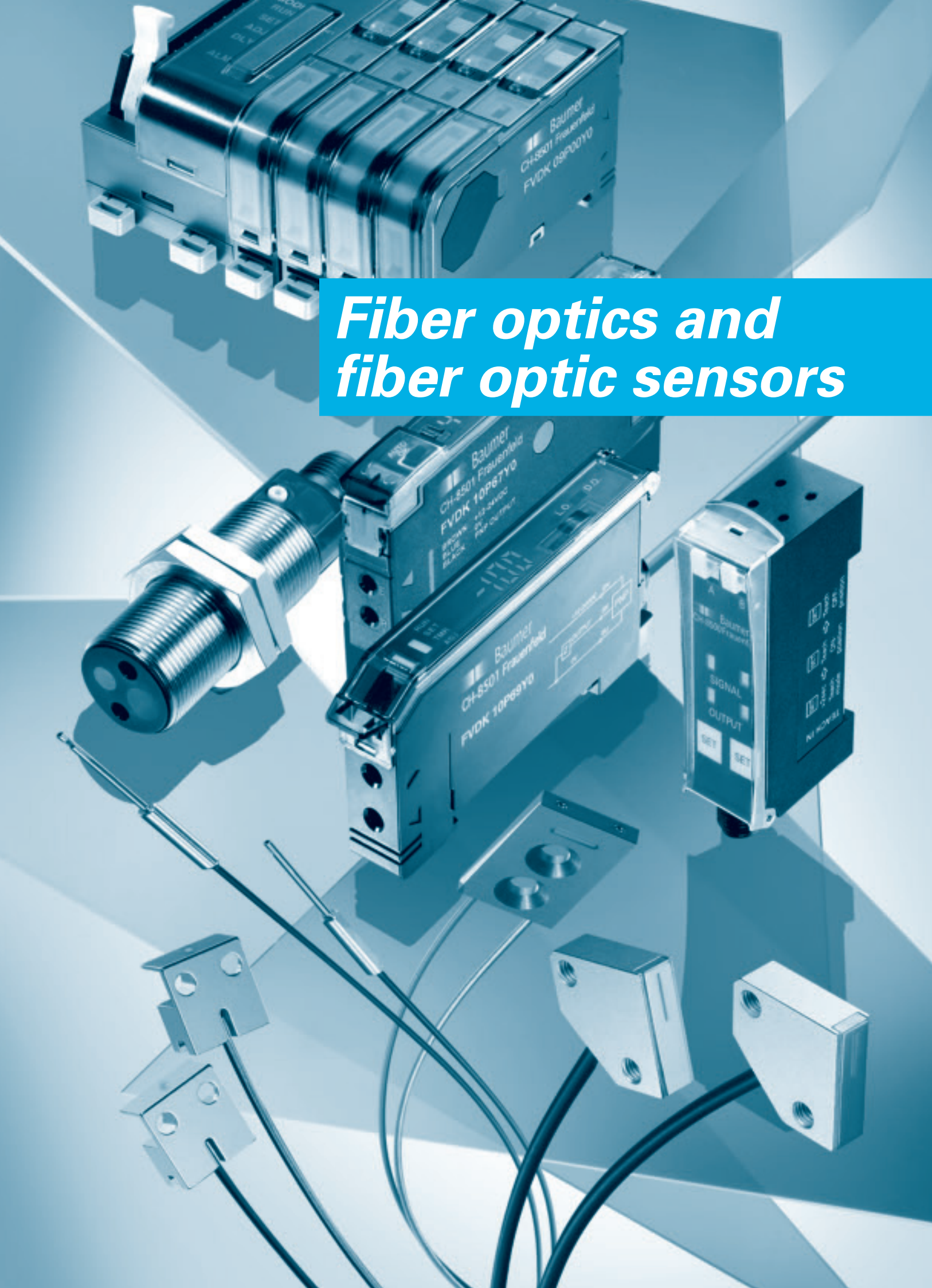

connection diagram

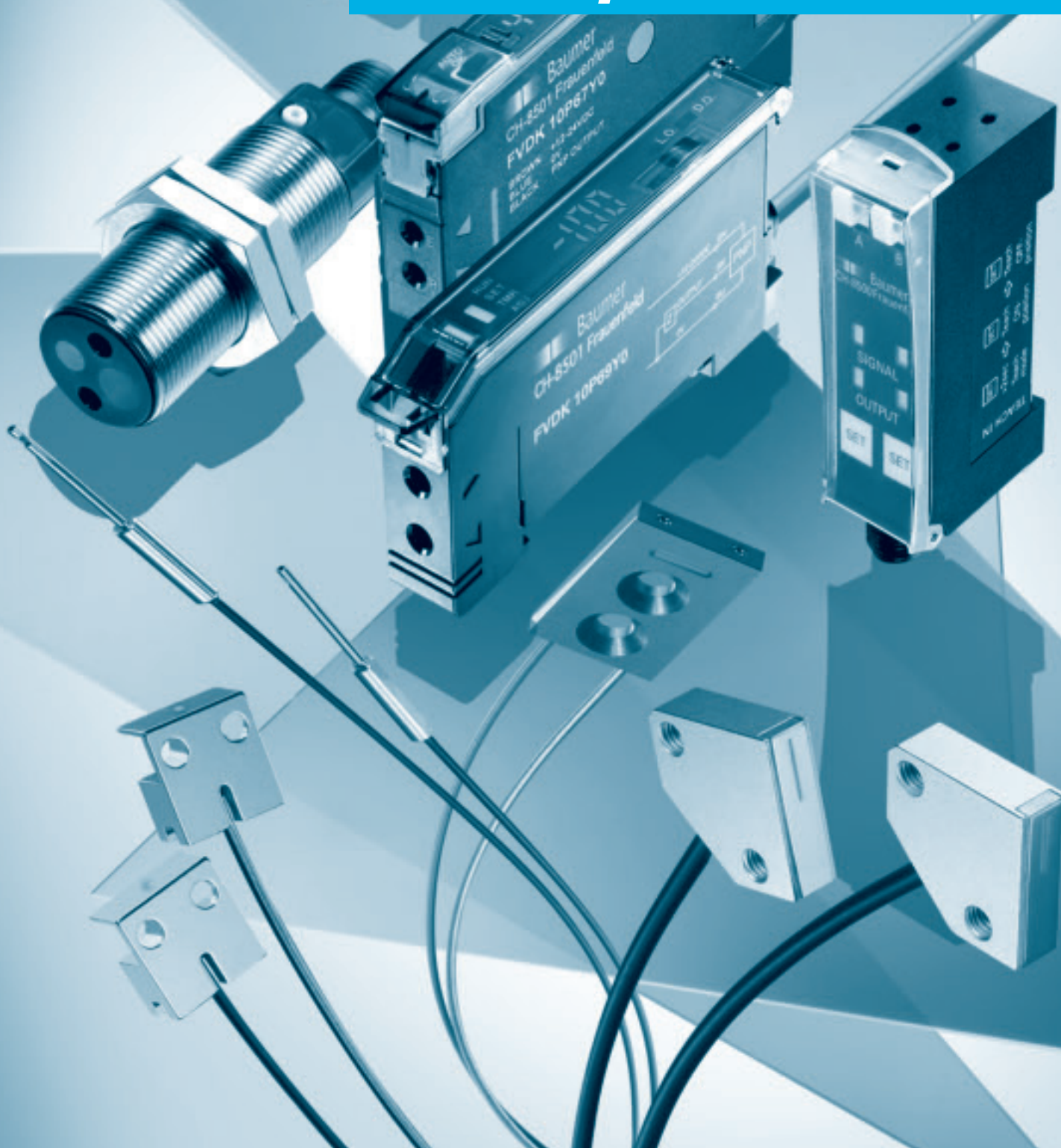









***Fiber optics and
fiber optic sensors***



| product family | FVDK 10 | FVDK 67 | FVDK 67 | FVDK 67 | FVDK 69 | FVDK 60 | FVDK 12 |
|------------------------------------|---|---|---|---|---|---|---|
| |  |  |  |  |  |  |  |
| width / diameter | 10,4 mm | 10 mm | 10 mm | 10 mm | 10 mm | 10 mm | 12 mm |
| actual range Sb (FSE 200C1002) | 160 mm | 1200 mm | 1200 mm | 1200 mm | 1400 mm | 320 mm | 320 mm |
| sensing distance Tw (FUE 200C1003) | 45 mm | 300 mm | 300 mm | 300 mm | 340 mm | 90 mm | 90 mm |
| response time / release time | < 1 ms | 0,05 ... 5 ms (adjustable) 0,058 ... 5 ms (adjustable) | 0,05 ... 5 ms (adjustable) 0,058 ... 5 ms (adjustable) | 0,14 ... 5 ms (adjustable) | 0,12 ... 5 ms (adjustable) | < 0,5 ms | < 1 ms |
| analog 1 ... 5 VDC | | | | | | | |
| NPN | ■ | ■ | ■ | ■ | ■ | ■ | ■ |
| PNP | ■ | ■ | ■ | ■ | ■ | ■ | ■ |
| cable | ■ | ■ | ■ | ■ | ■ | ■ | ■ |
| connector | ■ | ■ | | | ■ | ■ | ■ |
| housing material | plastic | plastic | plastic | plastic | plastic | plastic | plastic |
| | | | | | | | |
| Page | 452 | 454 | 455 | 456 | 457 | 458 | 459 |

| product family | FVDK 12 | FVDK 22 | FVDK 31 | FVDK 09 | FVDK 80 | FWDK 84 |
|------------------------------------|---|---|---|--|---|---|
| |  |  |  |  |  |  |
| width / diameter | 12 mm | 22 mm | 31 mm | 9 mm | 10 mm | 10 mm |
| actual range Sb (FSE 200C1002) | 140 mm | 320 mm | | 320 mm | 100 mm 240 mm 440 mm | 90 mm |
| sensing distance Tw (FUE 200C1003) | 40 mm | 90 mm | | 90 mm | 30 mm 70 mm 120 mm | 25 mm |
| response time / release time | < 0,05 ms | < 1 ms | < 1 ms | | < 0,05 ms (release time +0,02 ms) < 0,5 ms | 1 ... 50 ms (adjustable) |
| analog 1 ... 5 VDC | | | | | | ■ |
| NPN | | ■ | ■ | | ■ | |
| PNP | ■ | ■ | ■ | | ■ | |
| cable | | ■ | | | ■ | ■ |
| connector | ■ | ■ | ■ | | ■ | |
| housing material | plastic | plastic | plastic | plastic | plastic | plastic |
| | | | | | | |
| Page | 460 | 461 | 462 | 463 | 464 | 465 |

* for fiber optics see page 466 - 473



General information

Fiber optics are the extended vision of conventional sensors and, due to their miniature construction, can be installed directly in the most difficult ambient conditions. As only light is conveyed, fiber optics are intrinsically safe, which adds to their range of applications.

Plastic fiber optics are characterized primarily by the properties of the employed raw material – the plastic. Advances in the manufacture of plastics permit bending radii of just 1 mm for the optical fibers, which is completely impossible for glass fibers. Fiber materials are now available which are extremely tolerant to bending and thereby make their use in drag chains possible.

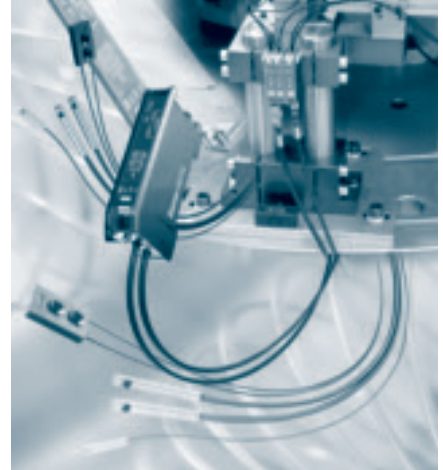

Typical applications

Due to their versatility, optical fibers can be used in the most diverse applications. The small, space-saving sensing heads are very suitable for use in very constricted conditions. It is also possible to monitor whole areas or execute precise positioning by the different arrangements of the fibers.

- Due to the light weight and space-saving construction, optical fibers can be integrated directly in pick & place tools
- Detection, differentiation and positioning of the most diverse objects
- Monitoring of whole areas with fiber optic arrays with linear fiber arrangement
- Use at high, low or constantly fluctuating ambient temperatures
- Detection of levels or leaks, including hazardous liquids
- Detection of transparent media such as glass, wafers or films with focused fiber optic reflective types

Characteristics and advantages

Independent of the surroundings

As only light is conveyed, electromagnetic fields, high or low temperatures have no effect on the functional reliability.

Space-saving

The smallest sensing heads have a diameter of 1,5 mm and are only 10 mm long. With bending radii of just 1 mm, it is possible to integrate the eye of the sensor even in the most constricted places.

Precise light spots

Fiber cross-sections of only 0,25 mm generate a fine core beam in fiber optic through beam types, whereas doubling lenses in fiber optic reflective types permit precise light spots of 0,1 mm.

Application-specific fiber arrangement

The coaxial fiber arrangement permits optimum light distribution over the receiver fibers and thereby makes precise positioning of objects possible. Also, fiber optic arrays with a linear fiber arrangement allow a whole area to be monitored or the detection of randomly conveyed objects.

Application feedback

Multi-digit displays integrated in the fiber optic sensors permit the stability of the application to be assessed and make fault analyses possible.

Fast processes

Fiber optic sensors with response times of only 50 microseconds allow the detection of objects even in very fast processes.



Technology and operation

The technology is based on intensity differences. The fiber optic through beam types detect an object breaking the light beam between the emitter and receiver. The fiber optic reflective types evaluate the amount of light reflected back from an object. The high-resolution analog/digital conversion in the fiber optic sensors permits very slight changes to be evaluated. This is important where the detection of small objects or differentiation of the finest contrasts is concerned.

Fundamentally, the fiber optics form a unit with the corresponding processing units, and the type of fiber optic head is mainly decisive for the detection of objects. The table below is intended to provide aid in understanding the large range of different sensing heads:

| Version/type | Properties | Field of application | Example types |
|-------------------------------|---|--|----------------------------------|
| Standard | Large selection of different shapes. Economical | Standard applications, simple object detection | FUE 200C1002 FUE 200C1004 |
| Coaxial | Homogenous light distribution over all receiver fibers. Lens adaptation possible | Optimally suited for positioning tasks. Highly accurate in combination with focusing lenses | FCE 200C1Y00 FCE 200D1Y00 |
| Side light exit | 90° light exit Reduced beam angle More installation space | Constricted conditions | FUE 200C4Y00 FSE 200C4002 |
| Array | Linear arrangement of the fibers. Line lengths of 5,25 - 21mm. Reflective or through beam types | Detection of objects which cannot be precisely conveyed. Measurement of object sizes or edge positions | FUE 200C6Y00 FSE 200C6Y00 |
| Longer range Parallel beam | Integrated lens Small beam angle Long range | Object detection and positioning over a long distance. No influencing by interfering objects close to the optical fiber | FLE 200C1Y00 FPE 200C1Y00 |
| Highly flexible | Min. bending radius down to 1mm Suitable for flexible installation | Constricted conditions | FUE 200E1Y00 FSE 200F6Y00 |
| Bendable | Extremely bendable, designed for bending more than 1 million times. | For use in drag chains or on moving parts | FUE 100E2Y00 FSE 200D1Y50 |
| Small light spot | In combination with focusing lenses, a light spot of only 0,1mm can be produced. | Detection of very small objects Highly accurate edge positioning | FCE 050C1Y10 with lens 134544 |
| Level detection | Special sensing tip to avoid liquid residues. Version for pipe/hose fitting | Detection of levels in different liquids, in or out of contact | FUL 200D2Y00 FSL 500C6Y00 |



Fiber optic sensors of the ranges FVDK 67 and FVDK 69 – versatile and multifunctional

The generation of multifunction fiber optic sensors is particularly suitable for handling processes, where very fast movements as well as exact positioning or the detection of very small objects is important. A single sensor undertakes the tasks which were formerly performed by many different sensors. The user can choose from 3 to 8 different operating modes from very short response time to high sensitivity to adapt the sensor optimally to his application. Despite the all-in-one concept, the requirement for simple operation is also fulfilled.



Characteristics and advantages

Comprehensive functions

Up to 7 different teach-in functions are integrated. For example, apart from the usual 2-point Teach-in method, there is also electronic background suppression or a dynamic teach-in function with which the fiber optic sensor automatically calculates the optimum switching point from the received signals. Integrated timer functions, closing and opening delays are adjustable in small steps from 250 μ s to max. 20 s.

Application feedback

The application feedback is particularly important during commissioning if consistent detection is to be ensured. The switching point and the relative received signal are indicated simultaneously on the 2x4-digit display of the FVDK 67 range. With this information, it can be determined at a glance whether the switching point has been optimally adjusted.

High resolution

Usually, the range is subdivided statically by a 12-bit A/D converter into 4096 individual, processable steps. In contrast to this, the FVDK 69 range offers a dynamic resolution with which the fiber optic sensor automatically selects the optimum resolution according to the range. The advantage of this is clearly in the detection of very small objects or of fine contrasts at short range.

The advantages at a glance



Type FVDK 67

- 8 operating modes and up to 6 different Teach-in functions available
- Switching point adjustment with Teach-in button or directly manual with +/- button
- 2x4-digit display, the switching point and received signal are indicated simultaneously
- Integrated interlock function to prevent undesired manipulation
- Up to 3 optical fibers can be installed directly adjacent to each other without optical interference
- Application-specific versions with external Teach-in and Teach-in feedback output or with 2 individually adjustable switching outputs



The advantages at a glance



Type FVKD 69

- 3 operating modes and 7 different Teach-in functions available
- Switching point adjustment with push-and-twist knob
- 1x3-digit display indicates the relative receiving signal
- Dynamic 10-bit resolution, optimized for detection of small objects or fine contrasts at close range
- Version with blue light source, permitting red and white marks to be discerned
- Adjustable protection against optical interference between two optical fibers

Teach-in or potentiometer? Just simple operation

The fiber optic sensors of the FVKD12, 22, 60, 80 and FVKD 84 ranges are characterized particularly by their simple handling. The sensitivity can be adjusted either with a potentiometer or a Teach-in button. Differently colored LEDs or simple displays provide the adjustment feedback. The sensor ranges differ primarily in their speed, sensitivity, hysteresis functions and supplementary functions such as timers, external Teach-in or logical output gates. However, all have the same thing in common: regardless of where the sensor is installed, the adjustment can be made practically without the need for operating instructions.

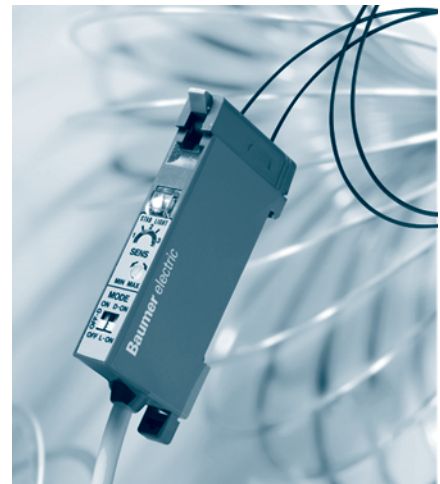

The advantages at a glance



Type FVKD 12

- Integrated, dynamic Teach-in permits the most reliable detection of moving objects or small parts for which it is difficult to find an exact Teach-in position
- High-speed version with a response time of only 50 μ s
- Integrated alarm output warns in advance of excessive soiling
- Protection class IP65



Type FVKD 22

- Two sensors in one housing reduces the necessary wiring
- The two integrated sensors do not interfere with each other
- It is possible to link the two outputs logically
- Version with external Teach-in from the controller



The advantages at a glance



Type FVDK 60

- The switching point and the relative receiving signal are visible on the 1-digit display
- Teach-in errors are indicated directly on the display
- Protection against optical interference between up to 3 optical fibers
- Version with external teach-in from the controller

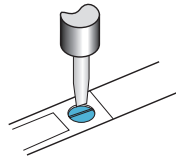

Type FVDK 80

- 3-turn potentiometer permits accurate adjustment of the sensitivity
- Version with low hysteresis of 10% (full scale) permits accurate positioning
- High-speed version with a response time of only 50 μ s
- Integrated alarm output warns in advance of excessive soiling
- Protection against optical interference between up to 3 optical fibers

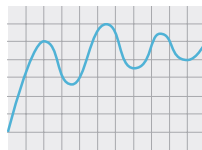

Type FWDK 84

- Analog voltage output 1–5 VDC
- Adjustable resolution of 0,3 to 6% (full scale)
- In combination with a fiber optic array, object sizes or positions can be determined within a range of up to 21 mm

Master/slave sensors – modular construction reduces the necessary wiring

The wiring of a machine represents a cost and time expenditure which must not be underestimated. The power supply and all output signals of the FVDK 31 range are connected to the controller by only one multi-core cable. Sensor groups can also be formed. The sensors are configured via the master, which is equipped with 2 JOG-dial rotary switches. A total of 7 different teach-in functions are available, which can be used individually for your application. The received signal of the individual slave unit is indicated on the easily legible display.



The advantages at a glance

- Up to 16 slaves can be programmed simultaneously via one master
- The 3-digit display indicates the reception level of each selected slave
- The wiring of the individual slave outputs is unnecessary due to plug connectors at the sides
- Up to 5 sensor groups can be formed, which can be connected with a cable of max. 2 m length
- 7 different teach-in functions and adjustable opening/closing delay
- Protection against optical interference between up to 4 optical fibers
- The side plug connector technique permits the replacement of individual units without having to detach the entire block

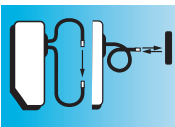

S_b = 160 mm
T_w = 45 mm

- sensitivity adjustable via potentiometer
- suppression of mutual optical interference



general data

| | |
|--|--------------------------|
| actual range S _b (FSE 200C1002) | 160 mm |
| sensing distance T _w (FUE 200C1003) | 45 mm |
| light source | pulsed red LED |
| light indicator | LED yellow |
| alignment / soiled lens indicator | flashing light indicator |
| adjustment | Pot 270° |
| wave length | 660 nm |
| suppression of reciprocal influence | yes |

electrical data

| | |
|------------------------------|----------------------|
| response time / release time | < 1 ms |
| voltage supply range +Vs | 10 ... 30 VDC |
| current consumption max. | 30 mA |
| current consumption typ. | 20 mA |
| voltage drop V _d | < 1,8 VDC |
| output function | light / dark operate |
| output current | < 100 mA |
| short circuit protection | yes |
| reverse polarity protection | yes |

mechanical data

| | |
|------------------|---------------|
| width / diameter | 10,4 mm |
| height / length | 27 mm |
| depth | 14 mm |
| type | rectangular |
| housing material | plastic (ASA) |

ambient conditions

| | |
|-----------------------|----------------|
| operating temperature | -25 ... +55 °C |
| protection class | IP 40 |

connectors

| | | |
|--------------|-------|--------------|
| ESG 32AH0200 | 4 pin | 2 m straight |
| ESW 31AH0200 | 4 pin | 2 m angular |

additional cable connectors and field wireable connectors, see accessories

accessories

| | |
|-----------------------------------|--------|
| SENSOFIX mounting kit | 150326 |
| mounting bracket (cable type) | 114501 |
| mounting bracket (connector type) | 133792 |

for details, see accessories section

dimension drawings

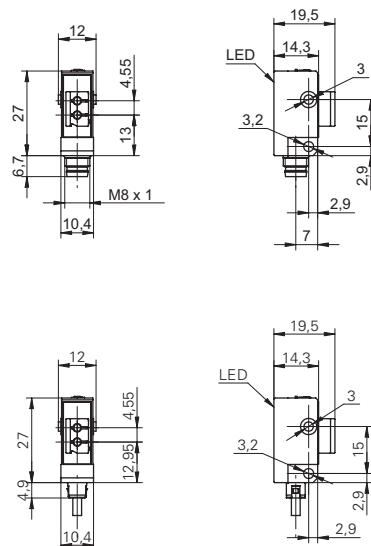

connection diagrams

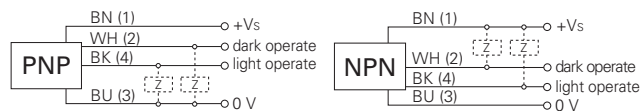

FVDK 10 S_b = 160 mm, T_w = 45 mm

Plastic fiber optic sensors

| order reference | output circuit | connection types |
|-------------------|----------------|------------------|
| FVDK 10N5101 | NPN | cable |
| FVDK 10N5101/S35A | NPN | connector M8 |
| FVDK 10P5101 | PNP | cable |
| FVDK 10P5101/S35A | PNP | connector M8 |

Reflective types (other types on demand)

| | Shape | Part number | TW = sensing distance [mm] |
|--|-------|--------------|----------------------------|
| <p>Standard M4</p> <p>Sensing head: brass</p> | | FUE 200C1004 | 18 |
| <p>Standard ø 3 mm</p> <p>Sensing head: stainless steel</p> | | FUE 200D2Y00 | 18 |
| <p>Coaxial M6</p> <p>Suitable for positioning</p> <p>Sensing head: stainless steel</p> | | FCE 200C1Y00 | 45 |
| <p>Coaxial M3</p> <p>Suitable for positioning. Spot sizes of 0,4 mm possible with doubling lens (see fiber optic accessories).</p> <p>Sensing head: stainless steel</p> | | FCE 200D1Y00 | 10 |

True beam types (other types on demand)

| Model Features | Shape | Part number | TW = sensing distance [mm] |
|---|-------|--------------|----------------------------|
| <p>Standard M4</p> <p>Sensing head: brass</p> | | FSE 200C1002 | 160 |
| <p>Standard M3</p> <p>Sensing head: brass</p> | | FSE 200C1004 | 50 |
| <p>Side view M4</p> <p>Sensing head: brass</p> | | FSE 200C4002 | 100 |
| <p>Array (fine light barrier)</p> <p>Reliably detects small, thin or vibrating workpieces in a light curtain of 5,25 mm.</p> <p>Sensing head: brass, Ni plated</p> | | FSE 200C6Y00 | 100 |

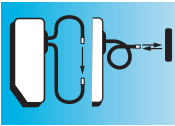

S_b = 1200 mm
T_w = 300 mm

- 2x4 digit display indicates the switching point and receiving light level
- versatile applicable due to 8 operating modes



general data

| | |
|--|---------------------|
| actual range S _b (FSE 200C1002) | 1200 mm |
| sensing distance T _w (FUE 200C1003) | 300 mm |
| light source | pulsed red LED |
| light indicator | 2 x 4-digit display |
| output indicator | LED orange |
| wave length | 660 nm |
| suppression of reciprocal influence | yes |

electrical data

| | |
|--------------------------------------|---------------------------------|
| voltage supply range +V _s | 10,8 ... 26,4 VDC |
| current consumption max. | 30 mA |
| voltage drop V _d | < 2,1 VDC |
| output function | light / dark operate switchable |
| on / off delay | 0,25 ... 20000 ms |
| min. output pulse length | 0,25 ... 20000 ms |
| short circuit protection | yes |
| reverse polarity protection | yes |

mechanical data

| | |
|------------------|-------------------|
| width / diameter | 10 mm |
| height / length | 33,8 mm |
| depth | 70,2 mm |
| type | rectangular |
| housing material | polycarbonate/ABS |

ambient conditions

| | |
|-----------------------|----------------|
| operating temperature | -20 ... +55 °C |
| protection class | IP 40 |

connectors

| | | |
|--------------|-------|--------------|
| ESG 32AH0200 | 4 pin | 2 m straight |
| ESW 31AH0200 | 4 pin | 2 m angular |

additional cable connectors and field wireable connectors, see accessories

accessories

| | |
|---|--------|
| mounting bracket for mounting on DIN Rail | 159806 |
|---|--------|

for details, see accessories section

dimension drawings

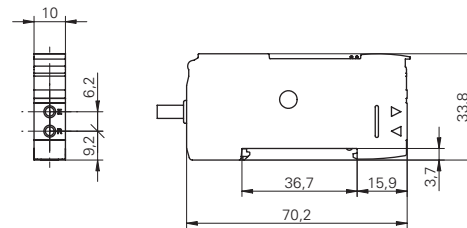
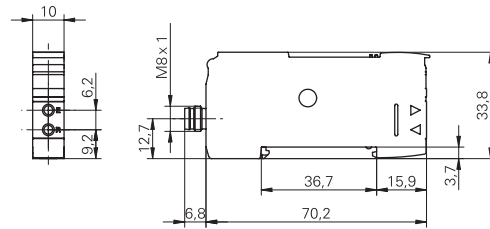

connection diagrams

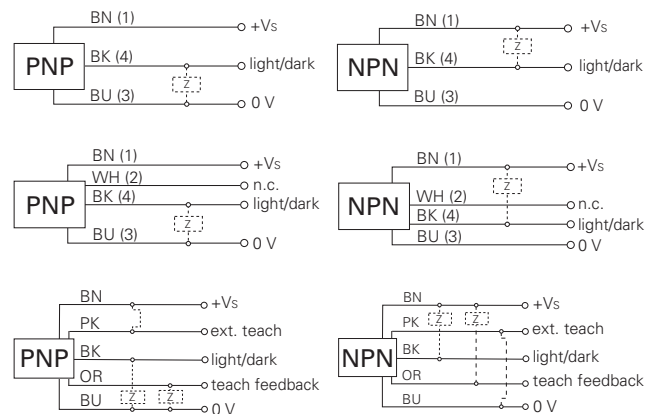

| order reference | adjustment | response time / release time | output circuit | output current | connection types |
|-------------------|-----------------------------|------------------------------|----------------|----------------|---------------------|
| FVDK 10N67Y0 | Teach-in | 0,05 ... 5 ms (adjustable) | NPN | < 100 mA | cable |
| FVDK 10N67Y0/S35A | Teach-in | 0,05 ... 5 ms (adjustable) | NPN | < 100 mA | connector M8, 4 pin |
| FVDK 10N67YR | Teach-in: button / external | 0,05 ... 5 ms (adjustable) | NPN | < 50 mA | cable |
| FVDK 10P67Y0 | Teach-in | 0,058 ... 5 ms (adjustable) | PNP | < 100 mA | cable |
| FVDK 10P67Y0/S35A | Teach-in | 0,058 ... 5 ms (adjustable) | PNP | < 100 mA | connector M8, 4 pin |
| FVDK 10P67YR | Teach-in: button / external | 0,058 ... 5 ms (adjustable) | PNP | < 50 mA | cable |

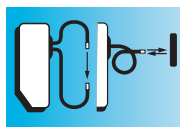

S_b = 1200 mm
T_w = 300 mm



- master/slave system with up to 16 extension units
- integrated dynamic auto-teach-in function
- 2x4 digit display

general data

| | |
|--|---------------------|
| actual range S _b (FSE 200C1002) | 1200 mm |
| sensing distance T _w (FUE 200C1003) | 300 mm |
| light source | pulsed red LED |
| light indicator | 2 x 4-digit display |
| output indicator | LED orange |
| adjustment | Teach-in |
| wave length | 660 nm |
| suppression of reciprocal influence | yes |

electrical data

| | |
|-----------------------------|---------------------------------|
| voltage supply range +Vs | 10,8 ... 26,4 VDC |
| current consumption max. | 30 mA |
| voltage drop V _d | < 2,1 VDC |
| output function | light / dark operate switchable |
| on / off delay | 0,25 ... 20000 ms |
| min. output pulse length | 0,25 ... 20000 ms |
| output current | < 50 mA |
| short circuit protection | yes |
| reverse polarity protection | yes |

mechanical data

| | |
|------------------|-------------------|
| width / diameter | 10 mm |
| height / length | 33,8 mm |
| depth | 70,2 mm |
| type | rectangular |
| housing material | polycarbonate/ABS |

ambient conditions

| | |
|-----------------------|----------------|
| operating temperature | -20 ... +55 °C |
| protection class | IP 40 |

accessories

| | |
|--------------------------------------|--------|
| mounting bracket for | 159806 |
| mounting on DIN Rail | |
| for details, see accessories section | |

dimension drawing

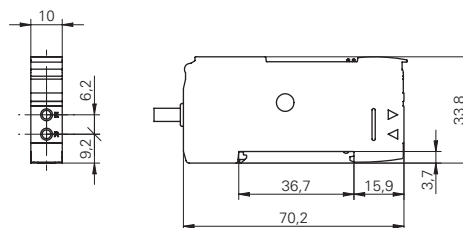

connection diagrams

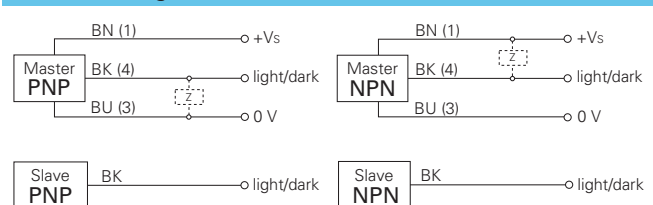

| order reference | type | response time / release time | output circuit | connection types |
|-----------------|--------|------------------------------|----------------|---------------------|
| FVDK 10N67YM | master | 0,05 ... 5 ms (adjustable) | NPN | cable |
| FVDK 10N67YS | slave | 0,05 ... 5 ms (adjustable) | NPN | cable (output only) |
| FVDK 10P67YM | master | 0,058 ... 5 ms (adjustable) | PNP | cable |
| FVDK 10P67YS | slave | 0,058 ... 5 ms (adjustable) | PNP | cable (output only) |

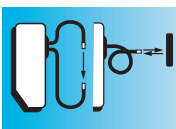

S_b = 1200 mm
Tw = 300 mm



- 2 adjustable outputs
- optional logical output operation
- 2x4 digit display

general data

| | |
|--|---------------------|
| actual range S _b (FSE 200C1002) | 1200 mm |
| sensing distance Tw (FUE 200C1003) | 300 mm |
| light source | pulsed red LED |
| light indicator | 2 x 4-digit display |
| output indicator | LED orange |
| adjustment | Teach-in |
| wave length | 660 nm |
| suppression of reciprocal influence | yes |

electrical data

| | |
|------------------------------|---------------------------------|
| response time / release time | 0,14 ... 5 ms (adjustable) |
| voltage supply range +Vs | 10,8 ... 26,4 VDC |
| current consumption max. | 30 mA |
| voltage drop V _d | < 2,1 VDC |
| output function | light / dark operate switchable |
| on / off delay | 0,25 ... 20000 ms |
| min. output pulse length | 0,25 ... 20000 ms |
| output current | < 30 mA |
| short circuit protection | yes |
| reverse polarity protection | yes |

mechanical data

| | |
|------------------|-------------------|
| width / diameter | 10 mm |
| height / length | 33,8 mm |
| depth | 70,2 mm |
| type | rectangular |
| housing material | polycarbonate/ABS |
| connection types | cable |

ambient conditions

| | |
|-----------------------|----------------|
| operating temperature | -20 ... +55 °C |
| protection class | IP 40 |

accessories

| | |
|---|--------|
| mounting bracket for mounting on DIN Rail | 159806 |
| for details, see accessories section | |

dimension drawing

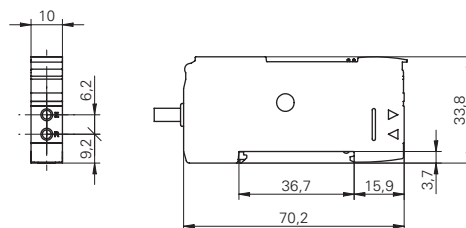

connection diagrams

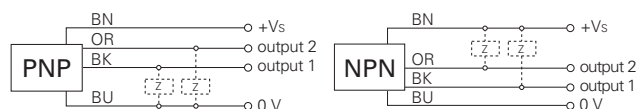

FVDK 67 S_b = 1200 mm, Tw = 300 mm

Plastic fiber optic sensors

| order reference | output circuit |
|-----------------|----------------|
| FVDK 10N67Y2 | NPN |
| FVDK 10P67Y2 | PNP |

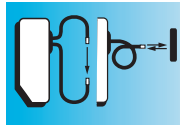

Sb = 1400 mm
Tw = 340 mm



- dynamic resolution principle, optimized for difficult applications
- versatile applicable due to 3 operating modes

general data

| | |
|-------------------------------------|---------------------|
| actual range Sb (FSE 200C1002) | 1400 mm |
| sensing distance Tw (FUE 200C1003) | 340 mm |
| light source | pulsed red LED |
| light indicator | 1 x 3-digit display |
| output indicator | LED orange |
| wave length | 660 nm |
| suppression of reciprocal influence | yes |

electrical data

| | |
|------------------------------|---------------------------------|
| response time / release time | 0,12 ... 5 ms (adjustable) |
| voltage supply range +Vs | 10,8 ... 26,4 VDC |
| current consumption max. | 30 mA |
| voltage drop Vd | < 2 VDC |
| output function | light / dark operate switchable |
| on / off delay | 1 ... 1000 ms |
| min. output pulse length | 1 ... 1000 ms |
| output current | < 100 mA |
| short circuit protection | yes |
| reverse polarity protection | yes |

mechanical data

| | |
|------------------|-------------------|
| width / diameter | 10 mm |
| height / length | 32 mm |
| depth | 60 mm |
| type | rectangular |
| housing material | polycarbonate/ABS |

ambient conditions

| | |
|-----------------------|----------------|
| operating temperature | -20 ... +55 °C |
| protection class | IP 40 |

connectors

| | | |
|--------------|-------|--------------|
| ESG 32AH0200 | 4 pin | 2 m straight |
| ESW 31AH0200 | 4 pin | 2 m angular |

additional cable connectors and field wireable connectors, see accessories

remarks

Blue light version on request.

dimension drawings

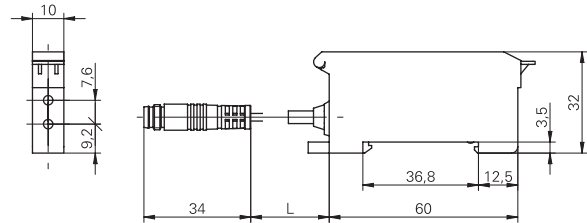
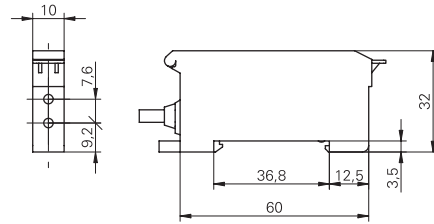

connection diagrams

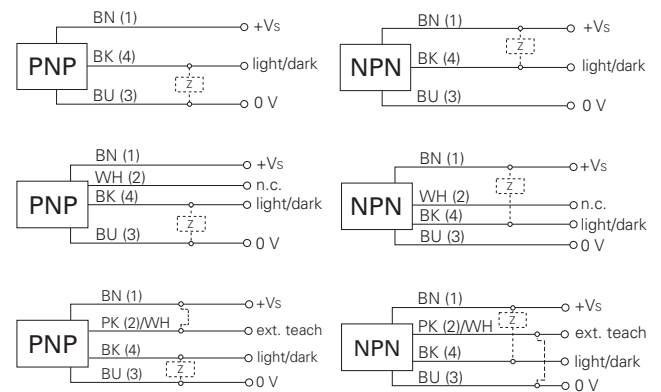

| order reference | adjustment | output circuit | connection types |
|--------------------|-----------------------------|----------------|-----------------------------|
| FVDK 10N69Y0 | Teach-in | NPN | cable |
| FVDK 10N69Y0/KS35A | Teach-in | NPN | flylead connector M8, 4 pin |
| FVDK 10N69YR | Teach-in: button / external | NPN | cable |
| FVDK 10P69Y0 | Teach-in | PNP | cable |
| FVDK 10P69Y0/KS35A | Teach-in | PNP | flylead connector M8, 4 pin |
| FVDK 10P69YR | Teach-in: button / external | PNP | cable |

Plastic fiber optic sensors FVDK 69 Sb = 1400 mm, Tw = 340 mm

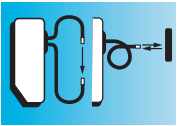

S_b = 320 mm
Tw = 90 mm



- visible excess gain signal on display
- sensitivity adjustable via Teach-in
- external teach-in via PLC

general data

| | |
|--|---------------------|
| actual range S _b (FSE 200C1002) | 320 mm |
| sensing distance Tw (FUE 200C1003) | 90 mm |
| light source | pulsed red LED |
| light indicator | 1 x 1-digit display |
| alignment / soiled lens indicator | LED green |
| output indicator | LED red |
| wave length | 680 nm |
| suppression of reciprocal influence | yes |

electrical data

| | |
|------------------------------|---------------------------------|
| response time / release time | < 0,5 ms |
| voltage supply range +Vs | 10 ... 30 VDC |
| current consumption max. | 50 mA |
| voltage drop V _d | < 1 VDC |
| output function | light / dark operate switchable |
| off delay | 40 ms |
| output current | < 100 mA |
| short circuit protection | yes |
| reverse polarity protection | yes |

mechanical data

| | |
|------------------|-------------------|
| width / diameter | 10 mm |
| height / length | 35,4 mm |
| depth | 60 mm |
| type | rectangular |
| housing material | polycarbonate/ABS |

ambient conditions

| | |
|-----------------------|----------------|
| operating temperature | -20 ... +55 °C |
| protection class | IP 40 |

connectors

| | | |
|--------------|-------|--------------|
| ESG 32AH0200 | 4 pin | 2 m straight |
| ESW 31AH0200 | 4 pin | 2 m angular |

additional cable connectors and field wireable connectors, see accessories

dimension drawings

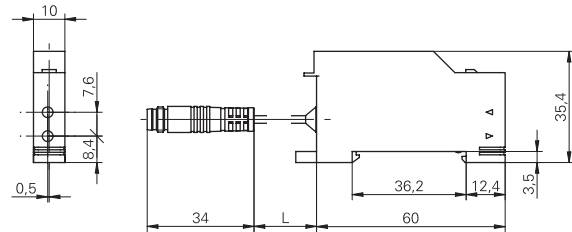
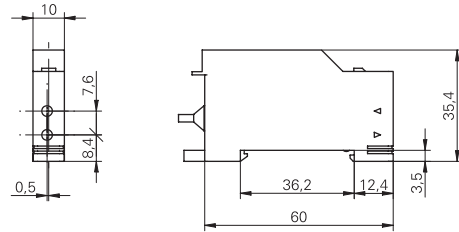

connection diagrams

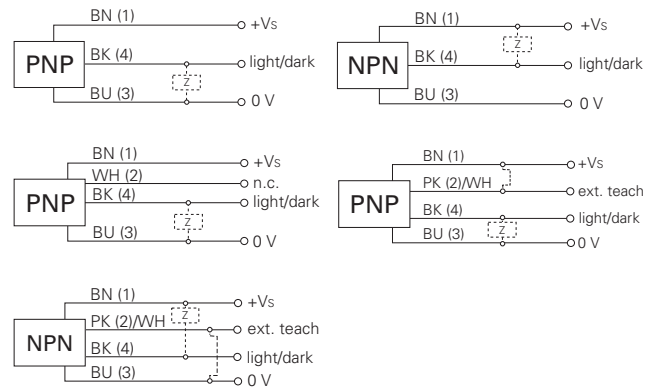

| order reference | adjustment | output circuit | connection types |
|--------------------|-----------------------------|----------------|-----------------------------|
| FVDK 10N60Y0 | Teach-in | NPN | cable |
| FVDK 10N65Y0 | Teach-in: button / external | NPN | cable |
| FVDK 10P60Y0 | Teach-in | PNP | cable |
| FVDK 10P60Y0/KS35A | Teach-in | PNP | flylead connector M8, 4 pin |
| FVDK 10P65Y0 | Teach-in: button / external | PNP | cable |
| FVDK 10P65Y0/KS35A | Teach-in: button / external | PNP | flylead connector M8, 4 pin |

FVDK 60 Sb = 320 mm, Tw = 90 mm

Plastic fiber optic sensors

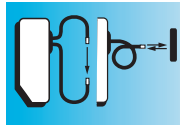

S_b = 320 mm
T_w = 90 mm

- sensitivity adjustable via Teach-in
- integrated alarm output
- protection class IP 65



general data

| | |
|--|---------------------|
| actual range S _b (FSE 200C1002) | 320 mm |
| sensing distance T _w (FUE 200C1003) | 90 mm |
| light source | pulsed red LED |
| light indicator | LED green |
| alignment / soiled lens indicator | LED green, flashing |
| output indicator | LED yellow |
| adjustment | Teach-in |
| wave length | 660 nm |

electrical data

| | |
|--------------------------------------|---------------------------------|
| response time / release time | < 1 ms |
| voltage supply range +V _s | 10 ... 30 VDC |
| current consumption max. | 46 mA |
| current consumption typ. | 36 mA |
| voltage drop V _d | < 1,8 VDC |
| output function | light / dark operate switchable |
| output current | < 100 mA |
| short circuit protection | yes |
| reverse polarity protection | yes |

mechanical data

| | |
|------------------|-------------|
| width / diameter | 12 mm |
| height / length | 33,2 mm |
| depth | 60 mm |
| type | rectangular |
| housing material | PBT / PC |

ambient conditions

| | |
|-----------------------|----------------|
| operating temperature | -25 ... +55 °C |
| protection class | IP 65 |

connectors

| | | |
|--------------|-------|--------------|
| ESG 32AH0200 | 4 pin | 2 m straight |
| ESW 31AH0200 | 4 pin | 2 m angular |

additional cable connectors and field wireable connectors, see accessories

dimension drawings

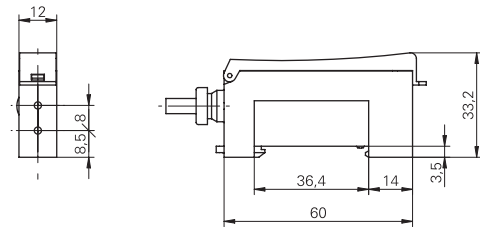
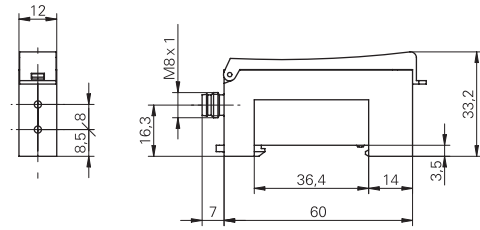

connection diagrams

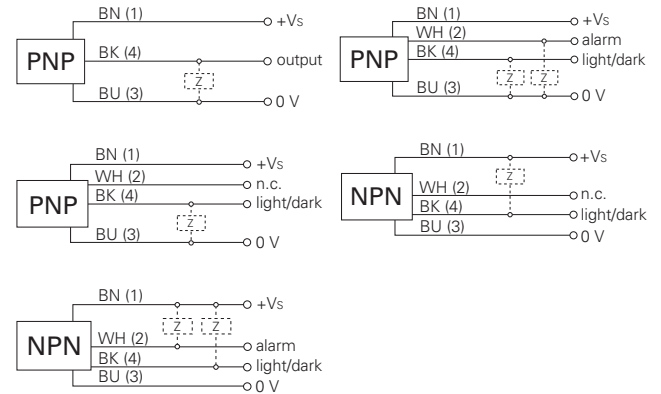

| order reference | min. output pulse length | output circuit | connection types | version |
|-------------------|--------------------------|----------------|---------------------|-------------------------|
| FVDK 12N6101/S35A | - | NPN | connector M8, 4 pin | - |
| FVDK 12N6401/S35A | - | NPN | connector M8, 4 pin | integrated alarm output |
| FVDK 12P6101 | - | PNP | cable | - |
| FVDK 12P6101/S35A | - | PNP | connector M8, 4 pin | - |
| FVDK 12P6401 | - | PNP | cable | integrated alarm output |
| FVDK 12P6401/S35A | - | PNP | connector M8, 4 pin | integrated alarm output |
| FVDK 12P6501/S35A | 40 ms | PNP | connector M8, 4 pin | integrated alarm output |

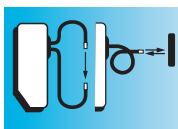

Sb = 140 mm



- Teach-in
- fast version available
- alarm output

general data

| | |
|------------------------------------|---------------------|
| version | fast version |
| actual range Sb (FSE 200C1002) | 140 mm |
| sensing distance Tw (FUE 200C1003) | 40 mm |
| light source | pulsed red LED |
| light indicator | LED green |
| alignment / soiled lens indicator | LED green, flashing |
| output indicator | LED yellow |
| adjustment | Teach-in |
| wave length | 660 nm |

electrical data

| | |
|------------------------------|---------------------------------|
| response time / release time | < 0,05 ms |
| voltage supply range +Vs | 10 ... 30 VDC |
| current consumption max. | 45 mA |
| current consumption typ. | 40 mA |
| voltage drop Vd | < 1,8 VDC |
| output function | light / dark operate switchable |
| output circuit | PNP |
| output current | < 100 mA |
| short circuit protection | yes |
| reverse polarity protection | yes |

mechanical data

| | |
|------------------|---------------------|
| width / diameter | 12 mm |
| height / length | 33,2 mm |
| depth | 60 mm |
| type | rectangular |
| housing material | PBT / PC |
| connection types | connector M8, 4 pin |

ambient conditions

| | |
|-----------------------|----------------|
| operating temperature | -25 ... +55 °C |
| protection class | IP 65 |

connectors

| | | |
|--------------|-------|--------------|
| ESG 32AH0200 | 4 pin | 2 m straight |
| ESW 31AH0200 | 4 pin | 2 m angular |

additional cable connectors and field wireable connectors, see accessories

dimension drawing

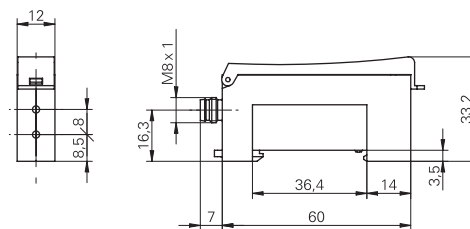

connection diagram

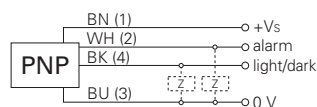

FVDK 12 Sb = 140 mm

Plastic fiber optic sensors

order reference

FVDK 12P6410/S35A

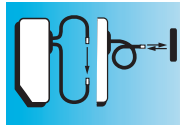

S_b = 320 mm
T_w = 90 mm

- 2 sensors in one housing
- sensitivity adjustable via Teach-in
- optional logical output operation



general data

| | |
|--|---------------------|
| actual range S _b (FSE 200C1002) | 320 mm |
| sensing distance T _w (FUE 200C1003) | 90 mm |
| light source | pulsed red LED |
| light indicator | LED green |
| alignment / soiled lens indicator | LED green, flashing |
| output indicator | LED yellow |
| wave length | 660 nm |
| suppression of reciprocal influence | yes |

electrical data

| | |
|--------------------------------------|---------------------------------|
| response time / release time | < 1 ms |
| voltage supply range +V _s | 10 ... 30 VDC |
| current consumption max. | 68 mA |
| current consumption typ. | 50 mA |
| voltage drop V _d | < 1,8 VDC |
| output function | light / dark operate switchable |
| output current | < 100 mA |
| short circuit protection | yes |
| reverse polarity protection | yes |

mechanical data

| | |
|------------------|-------------|
| width / diameter | 22 mm |
| height / length | 33,2 mm |
| depth | 60 mm |
| type | rectangular |
| housing material | PBT / PC |

ambient conditions

| | |
|-----------------------|----------------|
| operating temperature | -25 ... +55 °C |
| protection class | IP 65 |

connectors

| | | |
|----------|-------|--------------|
| ES 34CP2 | 5 pin | 2 m straight |
| ES 33CP2 | 5 pin | 2 m angular |

additional cable connectors and field wireable connectors, see accessories

dimension drawings

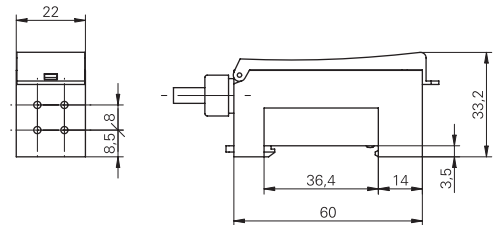
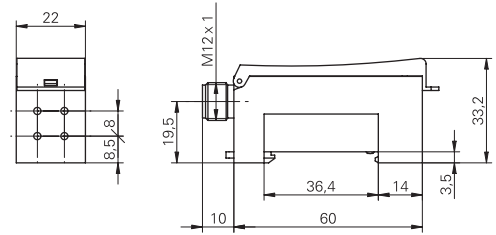

connection diagrams

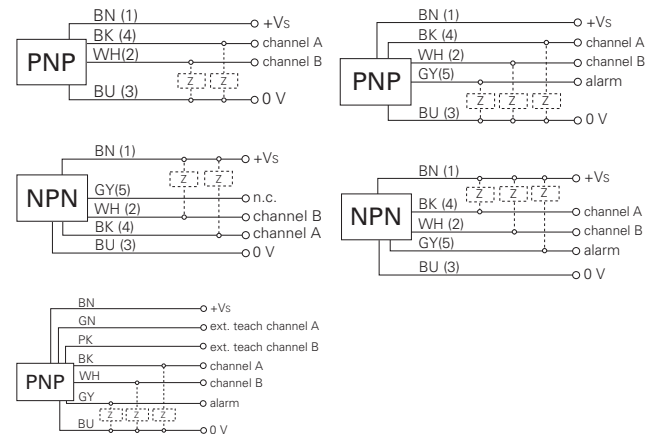

| order reference | adjustment | min. output pulse length | output circuit | connection types | version |
|-------------------|-----------------------------|--------------------------|----------------|----------------------|-------------------------|
| FVDK 22N6101/S14C | Teach-in | - | NPN | connector M12, 5 pin | - |
| FVDK 22N6401/S14C | Teach-in | - | NPN | connector M12, 5 pin | integrated alarm output |
| FVDK 22P6101 | Teach-in | - | PNP | cable | - |
| FVDK 22P6101/S14C | Teach-in | - | PNP | connector M12, 5 pin | - |
| FVDK 22P6401 | Teach-in | - | PNP | cable | integrated alarm output |
| FVDK 22P6401/S14C | Teach-in | - | PNP | connector M12, 5 pin | integrated alarm output |
| FVDK 22P6420 | Teach-in: button / external | - | PNP | cable | integrated alarm output |
| FVDK 22P6501/S14C | Teach-in | 40 ms | PNP | connector M12, 5 pin | integrated alarm output |

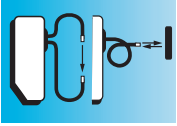

- master/slave system with up to 16 extension units
- all sensors can be set at the same time
- 3 digit display



general data

| | |
|-----------------|---------------------|
| type | master |
| light indicator | 1 x 3-digit display |
| adjustment | Teach-in |

electrical data

| | |
|------------------------------|---------------|
| response time / release time | < 1 ms |
| voltage supply range +Vs | 12 ... 24 VDC |
| current consumption max. | 60 mA |
| voltage drop Vd | < 1 VDC |
| on / off delay | 1 ... 1000 ms |
| min. output pulse length | 1 ... 1000 ms |
| output current | < 50 mA |
| short circuit protection | yes |
| reverse polarity protection | yes |

mechanical data

| | |
|------------------|-------------------|
| width / diameter | 31 mm |
| height / length | 35,9 mm |
| depth | 54 mm |
| type | rectangular |
| housing material | polycarbonate/ABS |

ambient conditions

| | |
|-----------------------|----------------|
| operating temperature | -20 ... +40 °C |
| protection class | IP 40 |

accessories

| | |
|--------------------------------------|--------|
| ribbon shielded cable 20 pin 2 m | 141139 |
| ribbon shielded cable 20 pin 5 m | 141140 |
| ribbon shielded cable 20 pin 10 m | 144161 |
| for details, see accessories section | |

dimension drawings

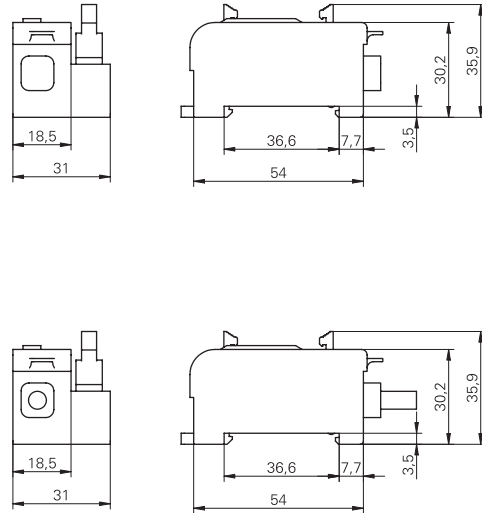

connection diagram

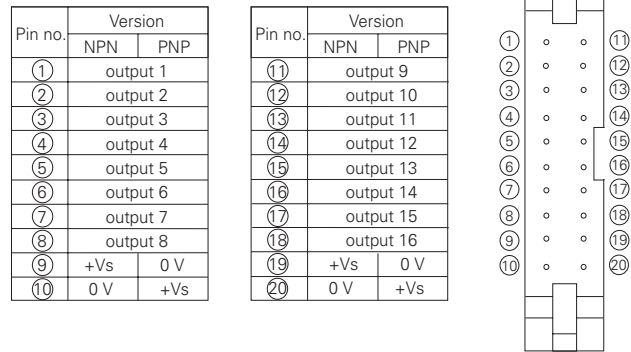

order reference output circuit connection types

| | | |
|---------------------|-----|-----------------------|
| FVDK 31N06Y0 | NPN | cable / MIL connector |
| FVDK 31P06Y0 | PNP | cable / MIL connector |
| FVDK 31P06Y1 | PNP | MIL connector |

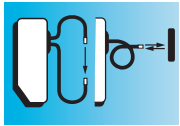

Sb = 320 mm
Tw = 90 mm



- FVDK 31 slave unit for master
- up to 16 slaves can be mounted
- reduced wiring

general data

| | |
|-------------------------------------|----------------|
| type | slave |
| actual range Sb (FSE 200C1002) | 320 mm |
| sensing distance Tw (FUE 200C1003) | 90 mm |
| light source | pulsed red LED |
| output indicator | LED orange |
| adjustment | no |
| wave length | 680 nm |
| suppression of reciprocal influence | yes |

electrical data

| | |
|--------------------------|---------------------------------|
| current consumption max. | 35 mA |
| output function | light / dark operate switchable |

mechanical data

| | |
|------------------|-------------------|
| width / diameter | 9 mm |
| height / length | 31,4 mm |
| depth | 54 mm |
| type | rectangular |
| housing material | polycarbonate/ABS |

ambient conditions

| | |
|-----------------------|----------------|
| operating temperature | -20 ... +40 °C |
| protection class | IP 40 |

order reference

FVDK 09P00Y0

dimension drawing

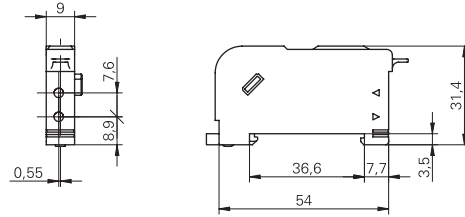

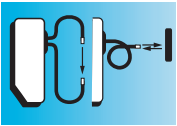

S_b = 440 mm
T_w = 120 mm



- sensitivity adjustable via potentiometer
- fast and high sensitivity version available
- integrated alarm output

general data

| | |
|-------------------------------------|---------------------|
| light source | pulsed red LED |
| light indicator | LED green |
| alignment / soiled lens indicator | LED green, flashing |
| output indicator | LED red |
| adjustment | potentiometer |
| wave length | 680 nm |
| suppression of reciprocal influence | yes |

electrical data

| | |
|-----------------------------|---------------------------------|
| voltage supply range +Vs | 10 ... 30 VDC |
| current consumption max. | 35 mA |
| voltage drop V _d | < 1 VDC |
| output function | light / dark operate switchable |
| off delay | 40 ms |
| output current | < 100 mA |
| short circuit protection | yes |
| reverse polarity protection | yes |

mechanical data

| | |
|------------------|-------------------|
| width / diameter | 10 mm |
| height / length | 29,7 mm |
| depth | 60 mm |
| type | rectangular |
| housing material | polycarbonate/ABS |

ambient conditions

| | |
|-----------------------|----------------|
| operating temperature | -20 ... +60 °C |
| protection class | IP 40 |

connectors

| | | |
|--------------|-------|--------------|
| ESG 32AH0200 | 4 pin | 2 m straight |
| ESW 31AH0200 | 4 pin | 2 m angular |

additional cable connectors and field wireable connectors, see accessories

dimension drawings

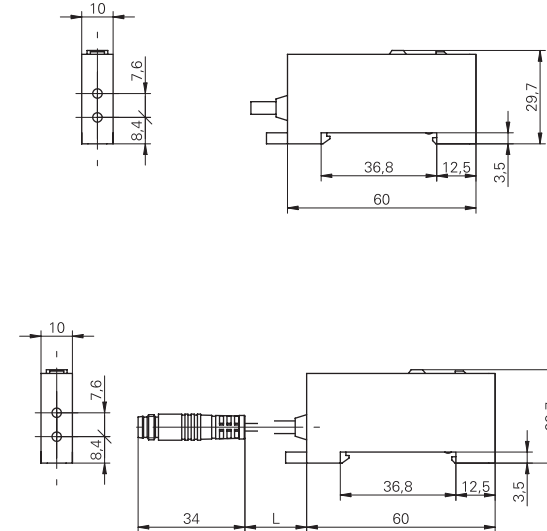

connection diagrams



| order reference | actual range S _b (FSE 200C1002) | sensing distance T _w (FUE 200C1003) | response time / release time | output circuit | connection types | version |
|--------------------|---|---|---|-------------------|-----------------------------------|------------------|
| FVDK 10N81Y0 | 240 mm | 70 mm | < 0,5 ms | NPN | cable | small hysteresis |
| FVDK 10N82Y0 | 100 mm | 30 mm | < 0,05 ms (release time +0.02 ms) | NPN | cable | fast version |
| FVDK 10N83Y0 | 440 mm | 120 mm | < 0,5 ms | NPN | cable | high sensitivity |
| FVDK 10P81Y0 | 240 mm | 70 mm | < 0,5 ms | PNP | cable | small hysteresis |
| FVDK 10P81Y0/KS35A | 240 mm | 70 mm | < 0,5 ms | PNP | flylead connector M8, 4 pin | small hysteresis |
| FVDK 10P82Y0 | 100 mm | 30 mm | < 0,05 ms (release time +0.02 ms) | PNP | cable | fast version |
| FVDK 10P82Y0/KS35A | 100 mm | 30 mm | < 0,05 ms (release time +0.02 ms) | PNP | flylead connector M8, 4 pin | fast version |
| FVDK 10P83Y0 | 440 mm | 120 mm | < 0,5 ms | PNP | cable | high sensitivity |
| FVDK 10P83Y0/KS35A | 440 mm | 120 mm | < 0,5 ms | PNP | flylead connector M8, 4 pin | high sensitivity |

FVDK 80 S_b = 440 mm, T_w = 120 mm

Plastic fiber optic sensors

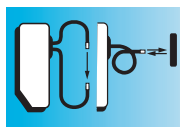

Sb = 90 mm
Tw = 25 mm



- analog output 1-5 VDC
- adjustable resolution

general data

| | |
|------------------------------------|--------------------------|
| actual range Sb (FSE 200C1002) | 90 mm |
| sensing distance Tw (FUE 200C1003) | 25 mm |
| light source | pulsed red LED |
| alignment / soiled lens indicator | LED red |
| output indicator | LED green |
| adjustment | potentiometer |
| resolution | 0,3 ... 6 % (Full Scale) |
| wave length | 680 nm |

electrical data

| | |
|------------------------------|--------------------------|
| response time / release time | 1 ... 50 ms (adjustable) |
| voltage supply range +Vs | 10,8 ... 26,4 VDC |
| current consumption max. | 40 mA |
| output circuit | analog 1 ... 5 VDC |
| load resistance | > 10 kOhm |
| short circuit protection | yes |
| reverse polarity protection | yes |

mechanical data

| | |
|------------------|-------------------|
| width / diameter | 10 mm |
| height / length | 29,7 mm |
| depth | 60 mm |
| type | rectangular |
| housing material | polycarbonate/ABS |
| connection types | cable |

ambient conditions

| | |
|-----------------------|----------------|
| operating temperature | -20 ... +60 °C |
| protection class | IP 40 |

order reference

FWDK 10U84Y0

dimension drawing

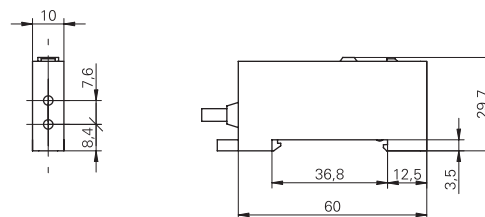

connection diagram

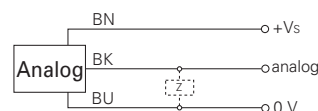

FWDK 84 Sb = 90 mm, Tw = 25 mm

Plastic fiber optic sensors

Plastic fiber optics Reflective types

FVDK 81
Low hysteresis

FVDK 12/22/31/60
Teach-in/Master-Slave

FVDK 82
Fast version

FVDK 67
Dual Display

FVDK 83
High sensitivity

FVDK 69
High Performance

FVDK 84
Analog output

Legend of operating modes
HS High Speed
nL Standard
HP High Sensitivity

| Model Features | Shape | Part number | TW = sensing distance [mm] |
|--|--|---------------------|----------------------------|
| Standard M6 Sensing head: brass | R = 15 mm Operating temperature: -30...+70 °C | FUE 200C1003 | |
| Standard ø 6 mm Smooth sensing head without thread Sensing head: aluminum | R = 15 mm Operating temperature: -30...+70 °C | FUE 200C2003 | |
| Standard M4 Sensing head: brass | R = 8 mm Operating temperature: -30...+70 °C | FUE 200C1004 | |
| Standard ø 4 mm Smooth sensing head without thread Sensing head: aluminum | R = 8 mm Operating temperature: -30...+70 °C | FUE 200C2004 | |
| Standard M3 Sensing head: stainless steel | R = 15 mm Operating temperature: -30...+70 °C | FUE 200D1Y00 | |
| Standard ø 3 mm Smooth sensing head without thread Sensing head: stainless steel | R = 15 mm Operating temperature: -30...+70 °C | FUE 200D2Y00 | |
| Long-distance M6 Longer sensing distance than with the standard version. With integrated lens. Sensing head: stainless steel | R = 20 mm Operating temperature: -30...+70 °C | FLE 200C1Y00 | |
| Long-distance M4 Longer sensing distance than with the standard version. With integrated lens. Sensing head: stainless steel | R = 15 mm Operating temperature: -30...+70 °C | FLE 200D1Y00 | |
| Ultra flexible M6 Ultra flexible type with bending radius of 2 mm Sensing head: stainless steel | R = 2 mm Operating temperature: -30...+70 °C | FUE 200E1Y00 | |

Plastic fiber optics

Reflective types

FVDK 81
Low hysteresis

FVDK 82
Fast version

FVDK 83
High sensitivity

FVDK 84
Analog output

FVDK 12/22/31/60
Teach-in/Master-Slave

HS nL HP
FVDK 67
Dual Display

HS nL HP
FVDK 69
High Performance

Legend of operating modes
HS High Speed
nL Standard
HP High Sensitivity

| Model Features | Shape | Part number | TW = sensing distance [mm] |
|---|--|---------------------|---|
| Ultra flexible, pliable M3 Highly flexible, extremely pliable fiber with a min. bending radius of 4 mm. Suitable for drag chains. Sensing head: stainless steel | <p>R = 4 mm Operating temperature: -30...+70 °C</p> | FUE 200F1Y00 | 12 6 - 20 15 5/40/50 9/40/60 |
| Coaxial M6 Suitable for positioning Sensing head: stainless steel | <p>R = 20 mm Operating temperature: -30...+70 °C</p> | FCE 200C1Y00 | 70 30 - 25 90 33/260/300 55/260/340 |
| Coaxial M4 Suitable for positioning Sensing head: stainless steel | <p>R = 15 mm Operating temperature: -30...+70 °C</p> | FCE 200C1Y01 | 20 12 - 40 8 25 12/80/110 20/80/120 |
| Coaxial M3 Suitable for positioning. Spot sizes of 0.1 mm possible with doubling lens (see fiber optic accessories). Sensing head: stainless steel | <p>R = 15 mm Operating temperature: -30...+70 °C</p> | FCE 200D1Y00 | 15 8 - 30 5 20 8/65/95 12/65/110 |
| Coaxial M3 Suitable for positioning. Spot sizes of 0.1 mm possible with doubling lens (see fiber optic accessories). Sensing head: stainless steel | <p>R = 15 mm Operating temperature: -30...+70 °C</p> | FCE 200D1Y01 | 15 8 - 30 5 20 8/65/95 12/65/110 |
| Coaxial M3 Suitable for positioning. Spot sizes of 0.1 mm possible with doubling lens (see fiber optic accessories). Sensing head: stainless steel | <p>R = 15 mm Operating temperature: -30...+70 °C</p> | FCE 050C1Y10 | 15 8 - 30 5 20 6/50/70 10/50/80 |
| Coaxial, ultra flexible M3 Ultra flexible. Suitable for positioning. Spot sizes of 0.1 mm possible with doubling lens (see fiber optic accessories). Sensing head: stainless steel | <p>R = 1 mm (emitter) R = 4 mm (receiver) Operating temperature: -30...+70 °C</p> | FCE 200E1Y00 | 13 6 - 26 4 18 6/50/70 10/50/80 |
| Side view ø 2 mm Smaller outside diameter, suitable for constrained conditions. Sensing head: stainless steel | <p>R = 15 mm Operating temperature: -30...+70 °C</p> | FUE 200C4Y00 | 9 3 - 14 10 4/30/45 6/30/50 |
| Smaller sensing head, flexible Chrome nickel sensing head which can be bent once. R > 7.5 mm. Other sensing head lengths on request. Sensing head: chrome nickel/brass | <p>R = 8 mm Operating temperature: -30...+70 °C</p> | FUE 200C1012 | 25 12 - 45 10 35 12/100/120 20/100/140 |

Plastic fiber optics

Reflective types

FVDK 81
Low hysteresis

FVDK 12/22/31/60
Teach-in/Master-Slave

FVDK 82
Fast version

FVDK 67
Dual Display

FVDK 83
High sensitivity

FVDK 69
High Performance

FVDK 84
Analog output

Legend of operating modes
HS High Speed
nL Standard
HP High Sensitivity

| Model Features | Shape | Part number | TW = sensing distance [mm] |
|---|--|---------------------|--|
| Small sensing head ø 1,5 mm Highly flexible, extremely pliable fiber with a min. bending radius of 4 mm. Suitable for drag chains. Sensing head: stainless steel | <p>R = 4 mm Operating temperature: -30...+70 °C</p> | FUE 100E2Y00 | 12 6 20 - 15 5/40/50 9/40/60 |
| Small sensing head ø 1,5 mm Suitable for small spaces Sensing head: stainless steel | <p>R = 15 mm Operating temperature: -30...+70 °C</p> | FUE 200C2Y00 | 25 12 45 9 35 12/90/120 20/90/140 |
| Small sensing head ø 0,82 mm Suitable for small spaces Sensing head: stainless steel | <p>R = 15 mm Operating temperature: -30...+70 °C</p> | FUE 050C2Y10 | 5 2 12 - 8 3/20/30 5/20/35 |
| Parallel beam M5 Sharp beam eliminates the influence of reflections from periphery. Spot size 3 mm at a distance of 20 mm. Sensing head: stainl. steel / Al | <p>R = 15 mm Operating temperature: -30...+70 °C</p> | FKE 200D1Y00 | 15 8 30 5 20 8/60/70 12/60/80 |
| Focus Suitable for detection of highly transparent objects (glass, foils) Sensing distance: 2,5 mm ±0,5 Sensing head: aluminum | <p>R = 15 mm Operating temperature: -30...+70 °C</p> | FFE 200D6Y00 | 2.5 - 2.5 - 2.5 2.5 2.5 |
| Array Reliably detects small, thin or vibrating workpieces in an area of 10,85 mm. Sensing head: brass, Ni plated | <p>R = 4 mm Operating temperature: -30...+70 °C</p> | FUE 200C6Y00 | 70 30 120 20 80 30/200/270 50/200/320 |
| Heat resistant M6 Heat resistant up to +105 °C Sensing head: stainless steel | <p>R = 25 mm Operating temperature: -30...+105 °C</p> | FUA 200C1Y00 | 50 25 100 18 70 27/200/220 45/200/260 |
| Heat and cold resistant M6 Continuous use from -60 °C up to +150 °C Sensing head: stainless steel | <p>R = 35 mm Operating temperature: -60...+150 °C</p> | FUB 200C1Y00 | 80 40 160 28 110 42/300/400 70/300/460 |
| Heat and cold resistant M6 Continuous use from -60 °C up to +350 °C (Glass fiber optics) Sensing head: stainless steel | <p>R = 25 mm Operating temperature: -60...+350 °C</p> | FUG 200C1Y00 | 50 25 100 18 70 27/180/220 45/180/260 |

Reflective types

Plastic fiber optics

Plastic fiber optics Through beam types

FVDK 81
Low hysteresis

FVDK 12/22/31/60
Teach-in/Master-Slave

FVDK 82
Fast version



HS nL HP
FVDK 67
Dual Display

FVDK 83
High sensitivity

HS nL HP
FVDK 69
High Performance

FVDK 84
Analog output

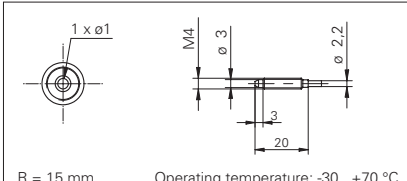
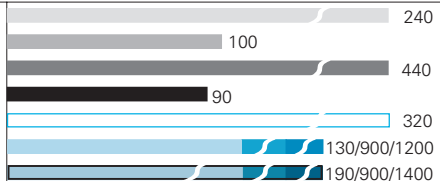
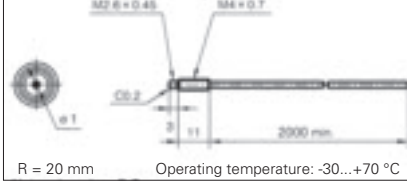
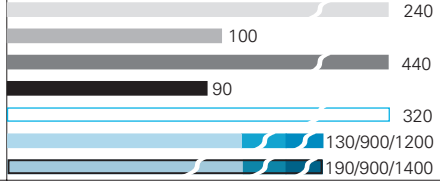
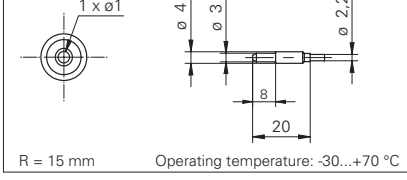
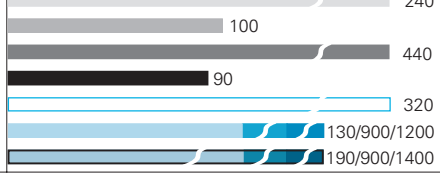
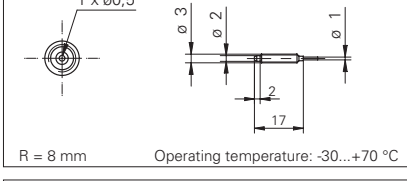
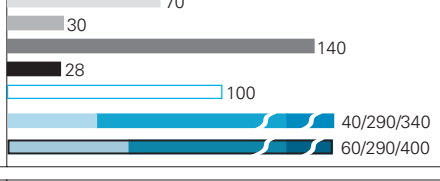
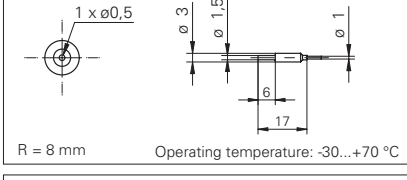
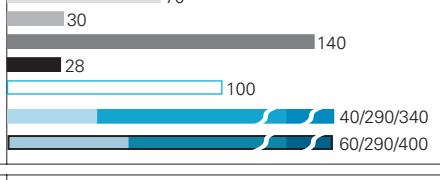
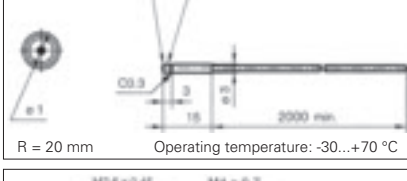
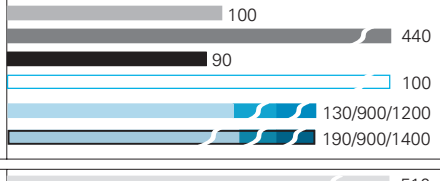
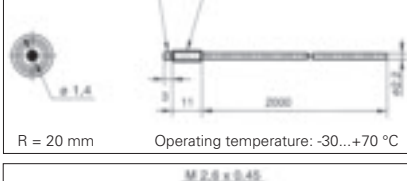
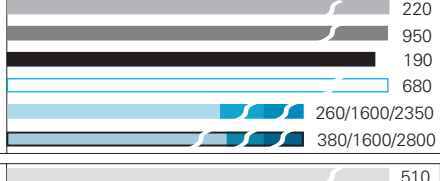
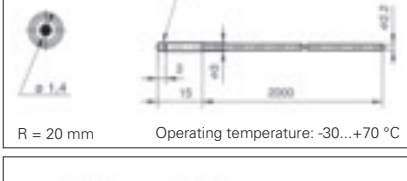
Legend of operating modes
HS High Speed
nL Standard
HP High Sensitivity

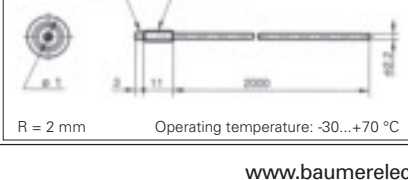
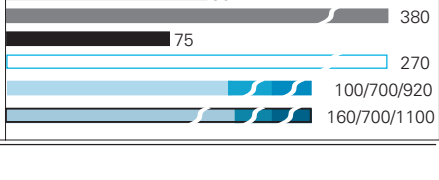
| Model Features | Shape | Part number | Sb = actual range [mm] |
|---|---|---------------------|---|
| Standard M4 Sensing head: brass |  | FSE 200C1002 |  |
| Standard M4 Shorter version Sensing head: stainless steel |  | FSE 200C1Y00 |  |
| Standard ø 4 mm Smooth sensing head without thread Sensing head: aluminum |  | FSE 200C2002 |  |
| Standard M3 Sensing head: brass |  | FSE 200C1004 |  |
| Standard ø 3 mm Smooth sensing head without thread Sensing head: aluminum |  | FSE 200C2004 |  |
| Standard ø 3 mm Shorter version Smooth sensing head without thread |  | FSE 200C2Y00 |  |
| Long distance M4 Twice the range of an M4 standard fiber optic sensor with integrated lens Sensing head: stainless steel |  | FWE 200C1Y00 |  |
| Long distance ø 3 mm Smooth sensing head without thread, with integrated lens Sensing head: stainless steel |  | FWE 200C2Y00 |  |
| Ultra flexible M4 Ultra flexible type with bending radius of 2 mm Sensing head: stainless steel |  | FSE 200E1Y00 |  |

Plastic fiber optics Through beam types

FVDK 81
Low hysteresis

FVDK 12/22/31/60
Teach-in/Master-Slave

FVDK 82
Fast version

FVDK 67
Dual Display

FVDK 83
High sensitivity

FVDK 69
High Performance

FVDK 84
Analog output

Legend of operating modes
HS High Speed
nL Standard
HP High Sensitivity

| Model Features | Shape | Part number | Sb = actual range [mm] |
|---|---|---------------------|--|
| Ultra flexible M3 Highly flexible fiber with a min. bending radius of 1 mm Sensing head: stainless steel | <p>R = 1 mm Operating temperature: -30...+70 °C</p> | FSE 200F1Y00 | 23 10 43 8 30 14/95/140 20/95/165 |
| Highly flexible, pliable M3 Highly flexible, extremely pliable fiber with a min. bending radius of 4 mm. Suitable for drag chains. Sensing head: stainless steel | <p>R = 4 mm Operating temperature: -30...+70 °C</p> | FSE 200D1Y50 | 40 20 100 20 45 18/120/180 22/120/210 |
| Ultra flexible, 3 mm Highly flexible, extremely pliable fiber with a min. bending radius of 2 mm. Sensing head: stainless steel | <p>R = 2 mm Operating temperature: -30...+70 °C</p> | FSE 200E2Y00 | 200 90 380 75 270 100/700/920 160/700/1100 |
| Side view M4 Sensing head: brass | <p>R = 15 mm Operating temp.: -30...+70 °C</p> | FSE 200C4002 | 150 60 280 55 200 80/600/750 120/600/880 |
| Side view ø 4 mm Smooth sensing head without thread Sensing head: aluminum | <p>R = 15 mm Operating temp.: -30...+70 °C</p> | FSE 200C4001 | 150 60 280 55 200 80/600/750 120/600/880 |
| Side view ø 1 mm Small sensing head Small target object detection Sensing head: stainless steel | <p>R = 15 mm Operating temperature: -30...+70 °C</p> | FSE 200D4Y00 | 38 16 70 14 50 20/130/160 30/130/200 |
| Side light exit, small sensing head 4 mm diameter, highly flexible Small target object detection Sensing head: stainless steel | <p>R = 1 mm Operating temperature: -30...+70 °C</p> | FSE 200F4Y00 | 11 5 22 4 15 5/40/55 9/40/65 |
| Small sensing head ø 1,5 mm Highly flexible, extremely pliable fiber with a min. bending radius of 4 mm. Suitable for drag chains. Sensing head: stainless steel | <p>R = 4 mm Operating temperature: -30...+70 °C</p> | FSE 200D2Y00 | 40 18 80 15 55 20/140/190 30/140/230 |
| Small sensing head ø 0,5 mm Detection of very small objects. Light spot diameter 0,25 mm Sensing head: stainless steel | <p>R = 15 mm Operating temperature: -30...+70 °C</p> | FSE 200D2Y50 | 11 5 21 4 15 5/35/52 9/35/60 |

Through beam types

Plastic fiber optics

Plastic fiber optics Through beam types

FVDK 81
Low hysteresis

FVDK 12/22/31/60
Teach-in/Master-Slave

FVDK 82
Fast version





FVDK 67
Dual Display

FVDK 83
High sensitivity

FVDK 69
High Performance

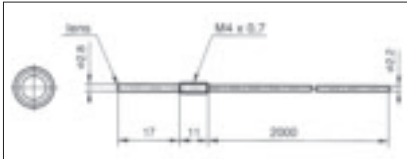
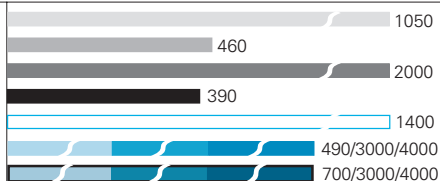
FVDK 84
Analog output

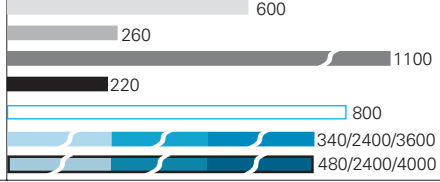
Legend of operating modes
HS High Speed
nL Standard
HP High Sensitivity

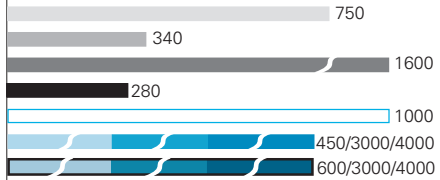
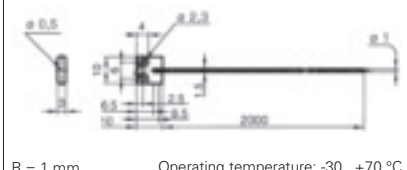
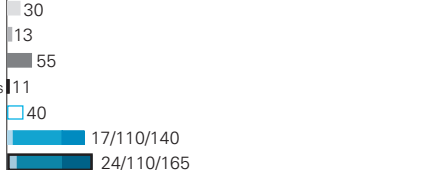
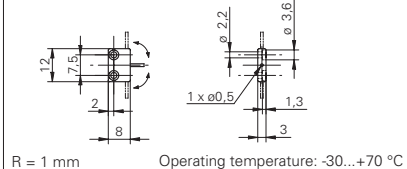
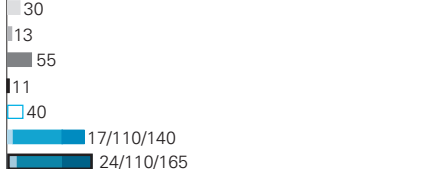
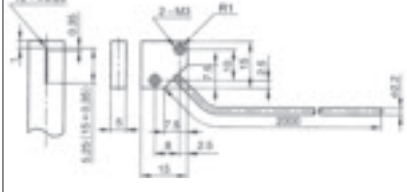
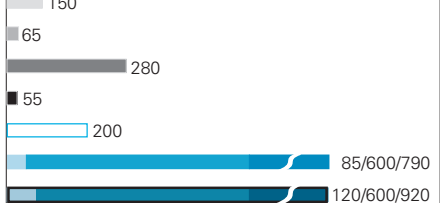
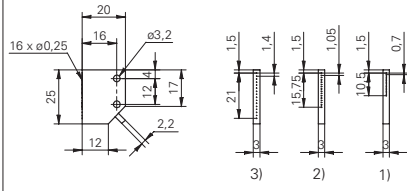
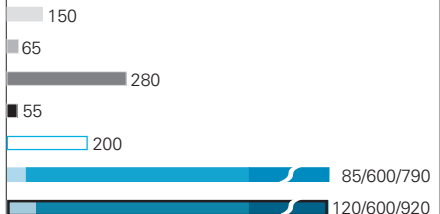
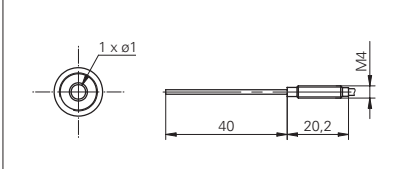
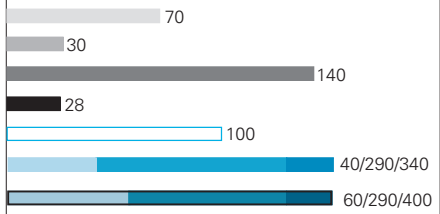
| Model Features | Shape | Part number | Sb = actual range [mm] |
|---|--|--|---|
| Parallel beam M4, exit angle ± 2° The small beam angle makes a precise, virtually parallel light beam. Sensing head: stainless steel |  <p>R = 20 mm Operating temperature: -30...+70 °C</p> | FPE 200C1Y00 |  |
| Parallel beam M4, exit angle ± 1° The small beam angle makes a precise, virtually parallel light beam. Sensing head: stainless steel |  <p>R = 15 mm Operating temperature: -30...+70 °C</p> | FPE 200D1Y00 |  |
| Parallel beam, side view ± 2° The small beam angle makes a precise, virtually parallel light beam. Sensing head: stainless steel |  <p>R = 30 mm Operating temperature: -30...+70 °C</p> | FPE 200C4Y00 |  |
| Flat sensing head, highly flexible fiber Can be mounted directly on a plate. Highly flexible fiber with a min. bending radius of 1 mm. Sensing head: brass, Ni plated |  <p>R = 1 mm Operating temperature: -30...+70 °C</p> | FSE 200F6Y00 With similar dimensions also available with an inexpensive POM sensing head: FSE 100F6Y01 |  |
| Flat sensing head, highly flexible fiber Highly flexible fiber with a min. bending radius of 1 mm. Sensing head: POM |  <p>R = 1 mm Operating temperature: -30...+70 °C</p> | FSE 100F6Y01 |  |
| Array (fine light barrier) Reliably detects small, thin or vibrating workpieces in a light curtain of 5,25 mm. Sensing head: brass, Ni plated |  <p>R = 4 mm Operating temperature: -30...+70 °C</p> | FSE 200C6Y00 |  |
| Array (fine light barrier) Reliably detects small, thin or vibrating workpieces in a light curtain: of 10,5, 15,75 and 21 mm. Sensing head: aluminum |  <p>R = 4 mm Operating temperature: -30...+70 °C</p> | ¹⁾ FSE 200C6Y01 ²⁾ FSE 200C6Y15 ³⁾ FSE 200C6Y02 |  |
| Small, bendable sensing head Chrome nickel sensing head which can be bent once. R > 7.5 mm. Other sensing head lengths on request. Sensing head: chrome nickel / brass |  <p>R = 8 mm</p> | FSE 200C1013 |  |

Plastic fiber optics Through beam types

FVDK 81
Low hysteresis

FVDK 12/22/31/60
Teach-in/Master-Slave

FVDK 82
Fast version

FVDK 67
Dual Display

FVDK 83
High sensitivity

FVDK 69
High Performance

FVDK 84
Analog output

Legend of operating modes
HS High Speed
nL Standard
HP High Sensitivity

| Model Features | Shape | Part number | Sb = actual range [mm] |
|---|--|---------------------|---|
| Heat resistant M4 Heat resistant up to +105 °C Sensing head: stainless steel | <p>R = 25 mm Operating temperature: -30...+105 °C</p> | FSA 200C1Y00 | 160 70 290 60 210 85/550/750 120/550/900 |
| Heat and cold resistant M4 Continuous use from -60 °C up to +150 °C Sensing head: stainless steel | <p>R = 35 mm Operating temperature: -60...+150 °C</p> | FSB 200C1Y00 | 230 100 430 85 310 120/900/1300 190/900/1500 |
| Heat and cold resistant M4 Continuous use from -60 °C up to +350 °C (Glass fiber optics) Sensing head: stainless steel | <p>R = 25 mm Operating temperature: -60...+350 °C</p> | FSG 200C1Y00 | 160 70 290 60 210 85/550/750 120/550/900 |
| Chemical and oil proof For use in chemically aggressive environments. Fiber optic sensor is fully sheathed in Teflon. Sensing head: stainless steel / PFA | <p>R = 80 mm Operating temperature: -30...+70 °C</p> | FSC 200C2Y00 | 900 400 1700 320 1200 500/3500/4000 720/3500/4000 |
| Chemical and oil proof For use in chemically aggressive environments. Fiber optic sensor is fully sheathed in Teflon. Sensing head: stainless steel / PFA | <p>R = 20 mm Operating temperature: -30...+70 °C</p> | FLC 200D2Y00 | 800 360 1600 300 1100 420/3300/4000 640/3300/4000 |
| Chemical and oil proof, side view For use in chemically aggressive environments. Fiber optic sensor is fully sheathed in Teflon. Sensing head: stainless steel / PFA | <p>R = 80 mm Operating temperature: -30...+70 °C</p> | FSC 200C4Y00 | 200 90 380 75 270 105/750/1020 150/750/1200 |
| Contact-free level detection Detects liquids in (semi-)transparent stand pipes/hoses with 3-13 mm diameter. Sensing head: PFI / PC | <p>R = 4 mm Operating temperature: -30...+70 °C</p> | FSL 500C6Y00 | Fiber optic sensor is mounted directly on the hose/stand pipe and switches on contact with escaping liquids. Recommend fiber optic sensor Series 69 and 67. Do not use with Series 82! More information can be found in chapter «Level and leak sensors». |
| | | | |
| | | | |

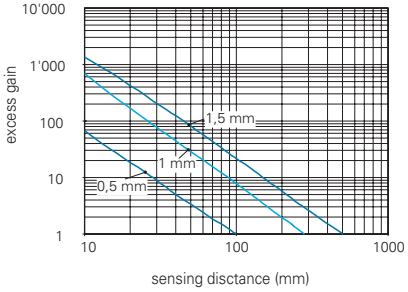
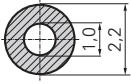
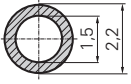

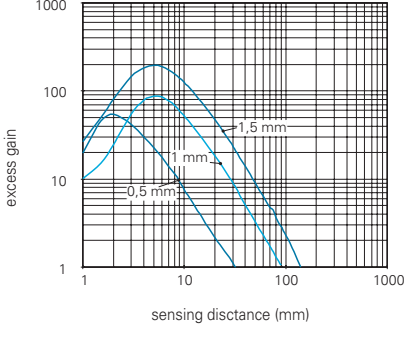
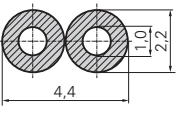
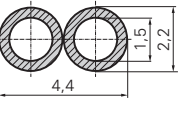

| through-beam types | fiber ø | fiber mm ² | min. bending radius | part nr. ¹⁾ | excess gain curve (2 m cut fiber) |
|--|---------|-----------------------|---------------------|------------------------|--|
|  | 0,5 mm | ≈ 0,2 mm ² | 8 mm | 114158 |  <p>reduction of sensing distance: 4% per meter (valid up to 10 m)</p> |
|  | 1 mm | ≈ 0,8 mm ² | 15 mm | 114157 | |
|  | 1,5 mm | ≈ 1,8 mm ² | 25 mm | 123729 | |

Highly flexible version on demand.

| reflective types | fiber ø | fiber mm ² | min. bending radius | part nr. ¹⁾ | excess gain curve (2 m cut fiber) |
|---|------------|---------------------------|---------------------|------------------------|--|
|  | 2 x 0,5 mm | ≈ 2 x 0,2 mm ² | 8 mm | 114594 |  <p>reduction of sensing distance: 4% per meter (valid up to 10 m)</p> |
|  | 2 x 1 mm | ≈ 2 x 0,8 mm ² | 15 mm | 114595 | |
|  | 2 x 1,5 mm | ≈ 2 x 1,8 mm ² | 25 mm | 124878 | |

Highly flexible version on demand.

¹⁾ order designation in meters

| product family | FZAM 18 | FZAM 18 | FZAM 18 | FZAM 30 | FVDM 15 |
|------------------------------|---|---|--|---|---|
| |  |  |  |  |  |
| width / diameter | 18 mm | 18 mm | 18 mm | 30 mm | 15 mm |
| actual range Sb | 310 mm | 800 mm | 800 mm | 600 mm 1400 mm | 1200 mm |
| sensing distance Tw | 60 mm | 150 mm | 150 mm | 110 mm 230 mm | 240 mm |
| response time / release time | < 0,5 ms | < 1 ms | < 1 ms | < 0,25 ms < 2,5 ms | < 0,1 ms < 1 ms |
| adjustment | Pot, 15 turn | Pot 270° | Teach-in | Pot, 20 turn | Pot, 20 turn |
| NPN | ■ | ■ | ■ | ■ | ■ |
| PNP | ■ | ■ | ■ | ■ | ■ |
| cable | ■ | ■ | ■ | ■ | ■ |
| connector | | ■ | ■ | | ■ |
| housing material | metal | metal | metal | metal | metal |
| Page | 478 | 479 | 480 | 481 | 486 |



General information

In contrast to plastic fiber optics, glass fiber optics contain hundreds of individual fibers. Each one conveys a part of the emitted light. Depending on the arrangement of the individual fibers, a homogenous light spot or a line can be produced. Also, glass is a high-quality, durable material, which guarantees a long and constant service life. This is only one of the reasons that glass optical fibers are used in the telecommunications industry. The high heat resistance also permits fields of application which are difficult or completely impossible with other sensors.

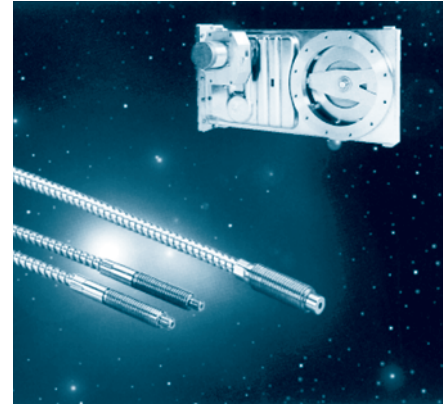

Typical applications

The wide range of sheath materials and sensing heads make it possible for you to adapt the sensors optimally to your machine concept. A way can always be found to fasten the small fiber optic heads. Due to the different available lengths, the fiber optic sensor can be placed individually at an optimum point.

- Metal-sheathed optical fibers can also be used in harsh conditions
- Detection, differentiation and positioning of different objects
- Monitoring of areas using fiber optic arrays with linear fiber arrangement
- Use at high, low or constantly fluctuating ambient temperatures
- Ranges of up to 1,4 m with fiber optic through beam types

Characteristics and advantages

Independent of the surroundings

As only light is conveyed, electromagnetic fields or high/low temperatures have no effect on the functional reliability.

Rugged

Metal-sheathed optical fibers are protected against mechanical effects (chips etc). All fiber optic sensors are fitted with a rugged metal housing.

Stable operation

High-quality glass fibers ensure stable operation for a long period. All fiber optic sensors are equipped with high-power infrared light sources, which provide sufficient excess gain even with a certain degree of soiling.

Area monitoring

Fiber optic arrays with a linear fiber arrangement permit an area to be monitored or the detection of objects which are not precisely conveyed.

Optimum installation

Apart from the common threaded types, fiber optic sensors with smooth sleeves or side light exit are available.

Fast processes

Fiber optic sensors with response times of only 50 microseconds permit the detection of objects even in very fast processes.



Technology and operation

By exploiting the so-called total reflection, it is possible to convey light in a medium such as glass without great loss.

Explanation of total reflection

When light waves reflect on a barrier layer between two media with different optical densities, they do not simply carry on in a straight line. When they penetrate from an optically denser medium (e.g. glass fiber core) into an optically thinner medium (e.g. glass sheath), there is a smaller angle, the critical angle, under which total reflection occurs. The light wave is reflected back and remains in the optically denser medium.

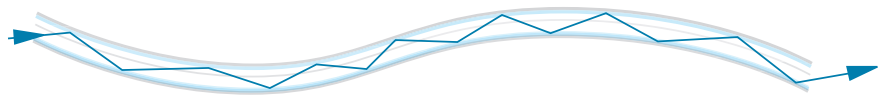

The glass sheath surrounding the core fiber is decisive for the transmission of light waves almost completely without loss. This ensures an optically consistent density of the sheath and the core and thereby permits a practically constant number of total reflections. This also occurs when the optical fiber is slightly bent. If there was no core sheath, it would be highly decisive for the total reflection whether the optical fiber is used in an air medium or, for example, water. The critical angle would then change decisively, which could permit an undesired escape of light under certain circumstances.

In the sensing principle, fiber optic solutions are based on intensity differences. With fiber optic through beam types, an object breaking the light beam between the emitter and receiver is detected. With the fiber optic reflective types, the amount of light reflected by an object is evaluated.

For more information, see the section on plastic fiber optics in this chapter.

Mounting and adjustment

Fiber optics series 15

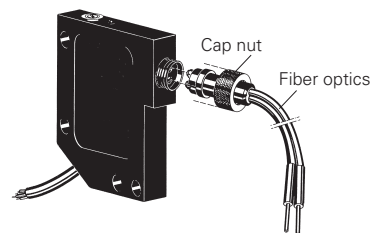

The cap nut to fasten the fiber optics is supplied with every order.

If damaged or lost, the cap nut can be ordered under the following number:

Cap nut 103230

Fiber optics series 18



The adjusting plate and cap nut are supplied with every order.

If damaged or lost, they can be ordered under the following part numbers:

Adjusting plate 101958
Cap nut 101480

Fiber optics series 30

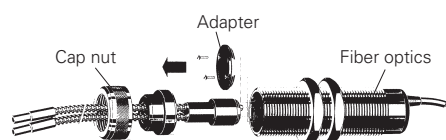

The adapter and the cap nut must be ordered as accessories with every order.

Adapter 102757
Cap nut 102801

For installation of the fiber optics, the cover must be removed.

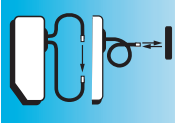

S_b = 310 mm
T_w = 60 mm



- sensitivity adjustable via potentiometer (axial)
- rugged metal housing
- infrared light source

general data

| | |
|-------------------------------------|-----------------------|
| actual range S _b | 310 mm |
| sensing distance T _w | 60 mm |
| light source | pulsed infrared diode |
| light indicator | LED yellow |
| alignment / soiled lens indicator | LED, flashing |
| adjustment | Pot, 15 turn |
| wave length | 880 nm |
| suppression of reciprocal influence | yes |

electrical data

| | |
|------------------------------|---------------|
| response time / release time | < 0,5 ms |
| voltage supply range +Vs | 10 ... 30 VDC |
| current consumption max. | 45 mA |
| current consumption typ. | 30 mA |
| voltage drop V _d | < 1,8 VDC |
| output function | light operate |
| output current | < 200 mA |
| short circuit protection | yes |
| reverse polarity protection | yes |

mechanical data

| | |
|------------------|--------------------------|
| width / diameter | 18 mm |
| height / length | 50 mm |
| type | cylindrical |
| housing material | brass nickel plated / PC |
| connection types | cable 3 pin |

ambient conditions

| | |
|-----------------------|----------------|
| operating temperature | -25 ... +55 °C |
| protection class | IP 65 |

accessories

| | |
|--------------------------------------|--------|
| <i>SENSOFIX</i> mounting kit | 151658 |
| adjusting plate | 101958 |
| cap nut | 101480 |
| for details, see accessories section | |

dimension drawing

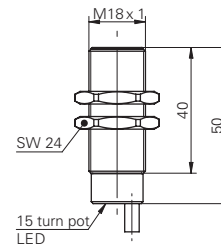

connection diagrams

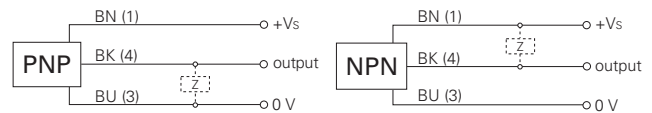

order reference **output circuit**

| | |
|---------------------|-----|
| FZAM 18N1155 | NPN |
| FZAM 18P1155 | PNP |

FZAM 18 S_b = 310 mm, T_w = 60 mm

Glass fiber optic sensors

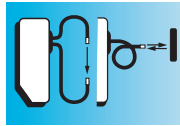

S_b = 800 mm
T_w = 150 mm

- sensitivity adjustable via potentiometer (radial)
- rugged metal housing
- infrared light source



| general data | |
|--|--------------------------|
| actual range S _b | 800 mm |
| sensing distance T _w | 150 mm |
| light source | pulsed infrared diode |
| light indicator | LED yellow |
| alignment / soiled lens indicator | LED, flashing |
| adjustment | Pot 270° |
| wave length | 880 nm |
| suppression of reciprocal influence | yes |
| electrical data | |
| response time / release time | < 1 ms |
| voltage supply range +V _s | 10 ... 30 VDC |
| current consumption max. | 45 mA |
| current consumption typ. | 30 mA |
| voltage drop V _d | < 1,8 VDC |
| output function | light operate |
| output current | < 200 mA |
| short circuit protection | yes |
| reverse polarity protection | yes |
| mechanical data | |
| width / diameter | 18 mm |
| type | cylindrical |
| housing material | brass nickel plated / PC |
| ambient conditions | |
| operating temperature | -25 ... +55 °C |
| protection class | IP 67 |
| connectors | |
| ESG 34AH0200 | 4 pin 2 m straight |
| ESW 33AH0200 | 4 pin 2 m angular |
| additional cable connectors and field wireable connectors, see accessories | |
| accessories | |
| SENSOFIX mounting kit | 151658 |
| adjusting plate | 101958 |
| cap nut | 101480 |
| for details, see accessories section | |

dimension drawings

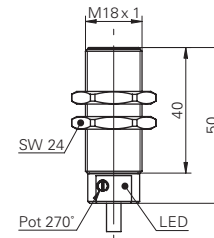
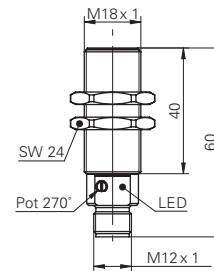

connection diagrams

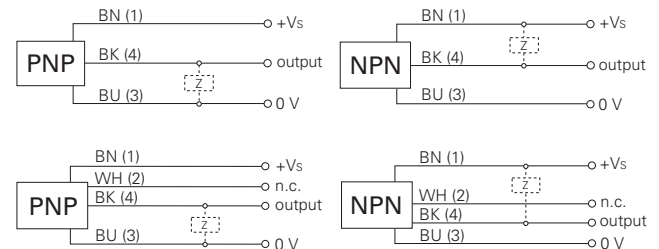

| order reference | height / length | output circuit | connection types |
|------------------|-----------------|----------------|----------------------|
| FZAM 18N1150 | 50 mm | NPN | cable 3 pin |
| FZAM 18N1150/S14 | 60 mm | NPN | connector M12, 4 pin |
| FZAM 18P1150 | 50 mm | PNP | cable 3 pin |
| FZAM 18P1150/S14 | 60 mm | PNP | connector M12, 4 pin |

FZAM 18 S_b = 800 mm, T_w = 150 mm

Glass fiber optic sensors

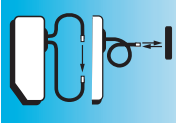

S_b = 800 mm
T_w = 150 mm

- sensitivity adjustable via Teach-in
- light / dark operation programmable
- rugged metal housing



general data

| | |
|-------------------------------------|-----------------------|
| actual range S _b | 800 mm |
| sensing distance T _w | 150 mm |
| light source | pulsed infrared diode |
| light indicator | LED green |
| alignment / soiled lens indicator | LED green, flashing |
| output indicator | LED yellow |
| adjustment | Teach-in |
| wave length | 880 nm |
| suppression of reciprocal influence | yes |

electrical data

| | |
|------------------------------|---------------------------------|
| response time / release time | < 1 ms |
| voltage supply range +Vs | 10 ... 30 VDC |
| current consumption max. | 55 mA |
| current consumption typ. | 40 mA |
| voltage drop V _d | < 1,8 VDC |
| output function | light / dark operate switchable |
| output current | < 200 mA |
| short circuit protection | yes |
| reverse polarity protection | yes |

mechanical data

| | |
|------------------|--------------------------|
| width / diameter | 18 mm |
| type | cylindrical |
| housing material | brass nickel plated / PC |

ambient conditions

| | |
|-----------------------|----------------|
| operating temperature | -25 ... +55 °C |
| protection class | IP 67 |

connectors

| | | |
|--------------|-------|--------------|
| ESG 34AH0200 | 4 pin | 2 m straight |
| ESW 33AH0200 | 4 pin | 2 m angular |

additional cable connectors and field wireable connectors, see accessories

accessories

| | |
|-----------------------|--------|
| SENSOFIX mounting kit | 151658 |
| adjusting plate | 101958 |
| cap nut | 101480 |

for details, see accessories section

dimension drawings

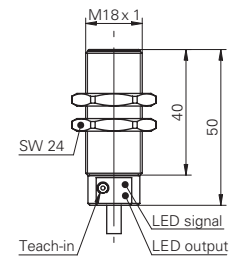
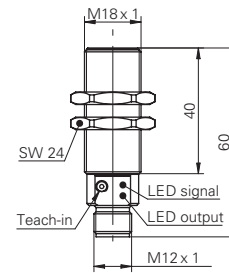

connection diagrams



| order reference | height / length | output circuit | connection types |
|------------------|-----------------|----------------|----------------------|
| FZAM 18N6460 | 50 mm | NPN | cable 4 pin |
| FZAM 18N6460/S14 | 60 mm | NPN | connector M12, 4 pin |
| FZAM 18P6460 | 50 mm | PNP | cable 4 pin |
| FZAM 18P6460/S14 | 60 mm | PNP | connector M12, 4 pin |

FZAM 18 S_b = 800 mm, T_w = 150 mm

Glass fiber optic sensors

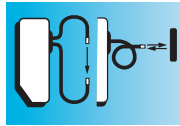

Sb = 1400 mm
Tw = 230 mm

- extended sensing distance
- fast version available
- rugged metal housing



| general data | |
|--------------------------------------|-----------------------|
| light source | pulsed infrared diode |
| light indicator | LED yellow |
| alignment / soiled lens indicator | LED, flashing |
| adjustment | Pot, 20 turn |
| wave length | 880 nm |
| electrical data | |
| voltage supply range +Vs | 10 ... 30 VDC |
| voltage drop Vd | < 2,5 VDC |
| output function | light / dark operate |
| output current | < 100 mA |
| short circuit protection | yes |
| reverse polarity protection | yes |
| mechanical data | |
| width / diameter | 30 mm |
| height / length | 66 mm |
| type | cylindrical |
| housing material | brass nickel plated |
| connection types | cable 4 pin |
| ambient conditions | |
| operating temperature | 0 ... +65 °C |
| protection class | IP 65 |
| accessories | |
| adapter | 102757 |
| cap nut | 102801 |
| for details, see accessories section | |

dimension drawing

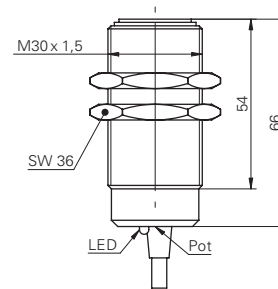

connection diagrams



| order reference | actual range Sb | sensing distance Tw | response time / release time | current consumption max. | current consumption typ. | output circuit |
|-----------------|-----------------|---------------------|------------------------------|--------------------------|--------------------------|----------------|
| FZAM 30N5001 | 600 mm | 110 mm | < 0,25 ms | 40 mA | 30 mA | NPN |
| FZAM 30N5004 | 1400 mm | 230 mm | < 2,5 ms | 50 mA | 33 mA | NPN |
| FZAM 30P5001 | 600 mm | 110 mm | < 0,25 ms | 40 mA | 30 mA | PNP |
| FZAM 30P5004 | 1400 mm | 230 mm | < 2,5 ms | 50 mA | 33 mA | PNP |

FZAM 30 Sb = 1400 mm, Tw = 230 mm

Glass fiber optic sensors

Glass fiber optics for Series 18, 30 Reflective types

Series 18 20-turn pot. Series 18 Side mounted pot. Teach-in Series 30 Fast version Series 30 Extended Tw

Reflective types

Glass fiber optics

| Fiber diameter 2 x 0,5 mm ² | | Part number | TW = sensing distance [mm] |
|--|---|---|----------------------------|
| Sheath material: PVC ø 2,5 mm (FUE ...) | Sheath material: brass chromium plated ø 4 mm (FUF ...) | | |
| | | FUE 050A2004 FUF 050A2004 (length 50 cm) | 10 20 15 35 |
| | | FUE 100A2004 FUF 100A2004 (length 100 cm) | 5 20 15 30 |
| | | FUE 050A2003 FUF 050A2005 (length 50 cm) | 10 20 15 35 |
| | | FUE 100A2003 FUF 100A2005 (length 100 cm) | 5 20 15 30 |
| | | FUE 050A1003 FUF 050A1005 (length 50 cm) | 10 20 15 35 |
| | | FUE 100A1003 FUF 100A1005 (length 100 cm) | 5 20 15 30 |
| | | FUE 050A4004 FUF 050A4004 (length 50 cm) | 10 20 15 35 |
| | | FUE 100A4004 FUF 100A4004 (length 100 cm) | 5 20 15 30 |
| Fiber diameter 2 x 1 mm ² | | Part number | TW = sensing distance [mm] |
| Sheath material: PUR ø 4,5 mm (FUE ...) | Sheath material: brass chromium plated ø 5 mm (FUF ...) | | |
| | | FUE 050A2002 FUF 050A2007 (length 50 cm) | 15 40 30 70 |
| | | FUE 100A2002 FUF 100A2007 (length 100 cm) | 15 40 30 60 |
| | | FUE 050A1002 FUF 050A1007 (length 50 cm) | 15 40 30 70 |
| | | FUE 100A1002 FUF 100A1007 (length 100 cm) | 15 40 30 60 |
| | | FUE 050A4005 FUF 050A4005 (length 50 cm) | 15 40 30 70 |
| | | FUE 100A4005 FUF 100A4005 (length 100 cm) | 15 40 30 60 |
| Fiber diameter 2 x 0,5 mm ² | | Part number | TW = sensing distance [mm] |
| Sheath material: Chrome-nickel-steel ø 2 mm FUH 010A2002 | | | |
| | | FUH 010A2002 (length 10 cm) | 10 20 15 35 |

Glass fiber optics for Series 18, 30

Reflective types

Series 18 20-turn pot. Series 18 Side mounted pot. Teach-in Series 30 Fast version Series 30 Extended TW

| Fiber diameter 2 x 2 mm ² | | Part number | TW = sensing distance [mm] |
|---|---|---|----------------------------|
| Sheath material: PUR \varnothing 4,5 mm (FUE ...) | Sheath material: brass chromium plated \varnothing 5 mm (FUF ...) | | |
| | | FUE 050A2011 FUF 050A2011 (length 50 cm) | 35, 80, 115 |
| | | FUE 100A2011 FUF 100A2011 (length 100 cm) | 35, 80, 115 |
| | | FUE 050A1011 FUF 050A1011 (length 50 cm) | 35, 80, 115 |
| | | FUE 100A1011 FUF 100A1011 (length 100 cm) | 35, 80, 115 |
| | | FUE 050A4003 FUF 050A4002 (length 50 cm) | 35, 80, 115 |
| | | FUE 100A4003 FUF 100A4002 (length 100 cm) | 35, 80, 115 |
| Fiber diameter 2 x 3 mm ² | | Part number | TW = sensing distance [mm] |
| Sheath material: PUR \varnothing 6 mm (FUE ...) | Sheath material: brass chromium plated \varnothing 6 mm (FUF ...) | | |
| | | FUE 050A2008 FUF 050A2003 (length 50 cm) | 60, 150, 210 |
| | | FUE 100A2008 FUF 100A2003 (length 100 cm) | 55, 150, 200 |
| | | FUE 050A1008 FUF 050A1003 (length 50 cm) | 60, 150, 210 |
| | | FUE 100A1008 FUF 100A1003 (length 100 cm) | 55, 150, 200 |
| | | FUE 050A3001 FUF 050A3001 (length 50 cm) | 60, 150, 210 |
| | | FUE 100A3001 FUF 100A3001 (length 100 cm) | 55, 150, 200 |
| Fiber diameter 2 x 4 mm ² | | Part number | TW = sensing distance [mm] |
| Sheath material: PUR \varnothing 6 mm (FUE ...) | Sheath material: brass chromium plated \varnothing 6 mm (FUF ...) | | |
| | | FUE 050A2001 FUF 050A2001 (length 50 cm) | 60, 150, 230 |
| | | FUE 100A2001 FUF 100A2001 (length 100 cm) | 60, 150, 220 |
| | | FUE 050A1001 FUF 050A1001 (length 50 cm) | 60, 150, 230 |
| | | FUE 100A1001 FUF 100A1001 (length 100 cm) | 60, 150, 220 |

Reflective types

Glass fiber optics

Glass fiber optics for Series 18, 30

Through beam types

Series 18
20-turn pot.

Series 18
Side mounted pot.
Teach-in

Series 30
Fast version

Series 30
Extended Sb

Through beam types

Glass fiber optics

| Fiber diameter 2 x 1 mm ² | | Part number | Sb = actual range [mm] |
|---|---|---|--------------------------|
| Sheath material: PVC ø 2,5 mm (FSE ...) | Sheath material: brass chromium plated ø 4 mm (FSF ...) | | |
| | | FSE 050A2002 FSF 050A2004 (length 50 cm) | 90 270 200 450 |
| | | FSE 050A2001 FSF 050A2005 (length 50 cm) | 90 270 200 450 |
| | | FSE 050A1001 FSF 050A1005 (length 50 cm) | 90 270 200 450 |
| | | FSE 050A4003 FSF 050A4003 (length 50 cm) | 90 270 200 450 |
| | | FSE 100A4003 FSF 100A4003 (length 100 cm) | 90 250 190 500 |
| Fiber diameter 2 x 2 mm ² | | Part number | Sb = actual range [mm] |
| Sheath material: PUR ø 4,5 mm (FSE ...) | Sheath material: brass chromium plated ø 5 mm (FSF ...) | | |
| | | FSE 050A2006 FSF 050A2002 (length 50 cm) | 180 450 380 450 |
| | | FSE 050A1006 FSF 050A1002 (length 50 cm) | 180 450 380 450 |
| | | FSE 100A2006 FSF 100A2002 (length 100 cm) | 170 500 370 860 |
| | | FSE 100A1006 FSF 100A1002 (length 100 cm) | 170 500 370 860 |
| | | FSE 050A4006 FSF 050A4002 (length 50 cm) | 180 450 380 450 |
| | | FSE 100A4006 FSF 100A4002 (length 100 cm) | 170 500 370 860 |

Glass fiber optics for Series 18, 30

Through beam types

Series 18 20-turn pot. Series 18 Side mounted pot. Teach-in Series 30 Fast version Series 30 Extended Sb

| Fiber diameter 2 x 4 mm ² | | Part number | Sb = actual range [mm] |
|---------------------------------------|---|---|---------------------------|
| Sheath material: PVC ø 4 mm (FSE ...) | Sheath material: brass chromium plated ø 5 mm (FSF ...) | | |
| | | FSE 050A2003 FSF 050A2001 (length 50 cm) | 310 500 500 500 |
| | | FSE 100A2003 FSF 100A2001 (length 100 cm) | 300 800 600 1400 |
| | | FSE 050A1003 FSF 050A1001 (length 50 cm) | 310 500 500 500 |
| | | FSE 100A1003 FSF 100A1001 (length 100 cm) | 300 800 600 1400 |
| | | FSE 050A4004 FSF 050A4004 (length 50 cm) | 310 500 500 500 |
| | | FSE 100A4004 FSF 100A4004 (length 100 cm) | 300 800 600 1400 |

Arrays (for Series 18 only)

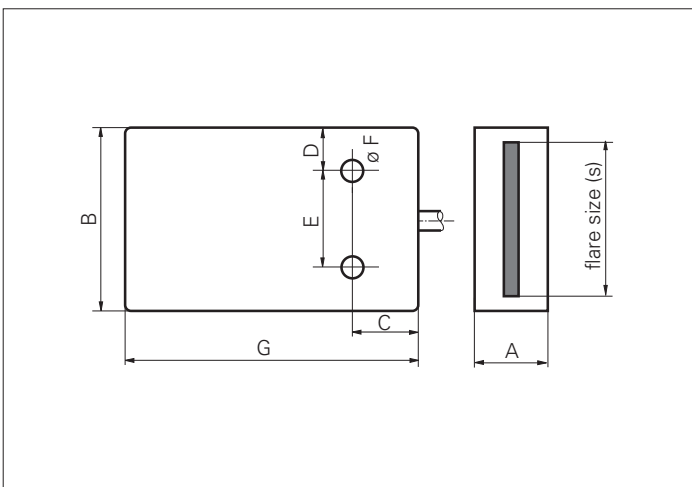

| Part number | Sb = actual range [mm] |
|---|------------------------|
| FSF 050A3020 FSE 050A3020 (length 50 cm) | 310 500 |
| FSF 100A3020 FSE 100A3020 (length 100 cm) | 310 800 |
| FSF 050A3021 FSF 050A3022 (length 50 cm) | 350 500 |
| FSF 100A3021 FSF 100A3022 (length 100 cm) | 350 900 |

| flare size s | dimensions mm | | | | | | | part number |
|----------------------------------|------------------|----|----|-----|----|-----|----|-------------------------------|
| | A | B | C | D | E | F | G | |
| 8 mm | 10 | 10 | - | - | - | - | 25 | FSF 050A3020 FSF 100A3020 |
| 8 mm | 10 | 10 | - | - | - | - | 25 | FSE 050A3020 FSE 100A3020 |
| 20 mm | 10 | 25 | 9 | 6.5 | 12 | 3,2 | 40 | FSF 050A3021 FSF 100A3021 |
| 35 mm | 12 | 40 | 12 | 7.5 | 25 | 4,2 | 50 | FSF 050A3022 FSF 100A3022 |
| metal sheath (FSF...) | | | | | | | | length 50 cm length 100 cm |
| plastic sheath (FSE...) (PUR) | | | | | | | | length 50 cm length 100 cm |

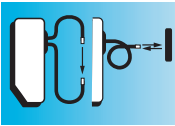

S_b = 1200 mm
T_w = 240 mm

- sensitivity adjustable via potentiometer
- fast version available
- rugged metal housing



general data

| | |
|-------------------------------------|-----------------------|
| actual range S _b | 1200 mm |
| sensing distance T _w | 240 mm |
| light source | pulsed infrared diode |
| light indicator | LED yellow |
| alignment / soiled lens indicator | LED, flashing |
| adjustment | Pot, 20 turn |
| wave length | 880 nm |
| suppression of reciprocal influence | yes |

electrical data

| | |
|--------------------------------------|----------------------|
| voltage supply range +V _s | 10 ... 30 VDC |
| voltage drop V _d | < 1,8 VDC |
| output function | light / dark operate |
| output current | < 200 mA |
| short circuit protection | yes |
| reverse polarity protection | yes |

mechanical data

| | |
|------------------|-------------------|
| width / diameter | 15 mm |
| height / length | 60 mm |
| depth | 45 mm |
| type | rectangular |
| housing material | die-cast aluminum |

ambient conditions

| | |
|-----------------------|----------------|
| operating temperature | -25 ... +65 °C |
| protection class | IP 65 |

connectors

| | | |
|--------------|-------|--------------|
| ESG 34AH0200 | 4 pin | 2 m straight |
| ESW 33AH0200 | 4 pin | 2 m angular |

additional cable connectors and field wireable connectors, see accessories

accessories

| | |
|------------------|--------|
| mounting bracket | 103415 |
|------------------|--------|

for details, see accessories section

dimension drawings

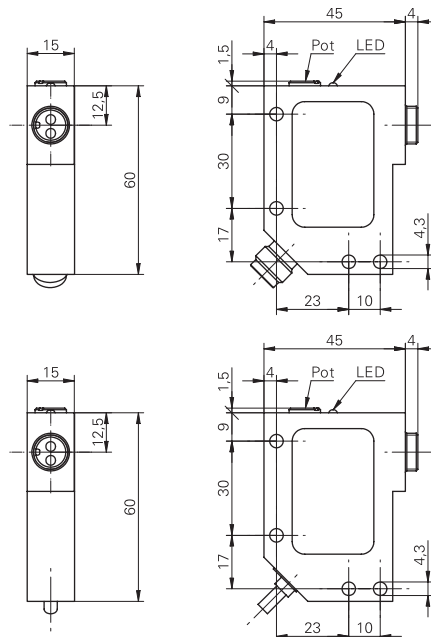

connection diagrams

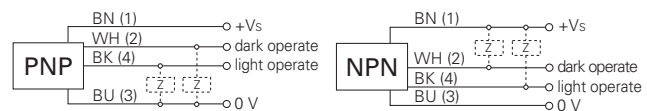

| order reference | response time / release time | current consumption max. | current consumption typ. | output circuit | connection types |
|------------------|------------------------------|--------------------------|--------------------------|----------------|----------------------|
| FVDM 15N5103 | < 1 ms | 46 mA | 30 mA | NPN | cable 4 pin |
| FVDM 15N5103/S14 | < 1 ms | 46 mA | 30 mA | NPN | connector M12, 4 pin |
| FVDM 15P5103 | < 1 ms | 46 mA | 30 mA | PNP | cable 4 pin |
| FVDM 15P5103/S14 | < 1 ms | 46 mA | 30 mA | PNP | connector M12, 4 pin |
| FVDM 15P5130 | < 0,1 ms | 60 mA | 50 mA | PNP | cable 4 pin |
| FVDM 15P5130/S14 | < 0,1 ms | 60 mA | 50 mA | PNP | connector M12, 4 pin |

FVDM 15 S_b = 1200 mm, T_w = 240 mm

Glass fiber optic sensors

Glass fiber optics for Series 15

Reflective types

Series 15

| Fiber diameter 2 x 0,5 mm ² | | Part number | TW = sensing distance [mm] |
|--|--|--|----------------------------|
| Sheath material: PVC ø 2,5 mm (FUE ...) | Sheath material: brass chromium plated ø 4 mm (FUF ...) | | |
| | | FUE 025B2004 FUF 025B2004 (length 25 cm) | 25 |
| | | FUE 025B2003 FUF 025B2003 (length 25 cm) | 25 |
| | | FUE 025B1003 FUF 025B1003 (length 25 cm) | 25 |
| | | FUE 025B4003 FUF 025B4006 (length 25 cm) | 25 |
| | | FUE 050B4003 FUF 050B4006 (length 50 cm) | 25 |
| Fiber diameter 2 x 1 mm ² | | Part number | TW = sensing distance [mm] |
| Sheath material: PUR ø 4,5 mm (FUE ...) | Sheath material: brass chromium plated ø 5 mm (FUF ...) | | |
| | | FUE 025B2002 FUF 025B2005 (length 25 cm) | 60 |
| | | FUE 025B1002 FUF 025B1005 (length 25 cm) | 60 |
| | | FUE 025B4005 FUF 025B4008 (length 25 cm) | 60 |
| | | FUE 050B4005 FUF 050B4008 (length 50 cm) | 60 |
| Fiber diameter 2 x 0,5 mm ² | Fiber diameter 2 x 1 mm ² | Part number | TW = sensing distance [mm] |
| Sheath material: Chrome-nickel-steel ø 2 mm FUH 010B2002 | Sheath material: Chrome-nickel-steel ø 3 mm FUH 010B2001 | | |
| | | FUH 010B2002 (length 10 cm) | 25 |
| | | FUH 010B2001 (length 10cm) | 60 |

Reflective types

Glass fiber optics

Glass fiber optics for Series 15

Reflective types

Series 15

Reflective types

Glass fiber optics

| Fiber diameter 2 x 2 mm ² | | Part number | TW = sensing distance [mm] |
|---|---|--|----------------------------|
| Sheath material: PUR \varnothing 4,5 mm (FUE ...) | Sheath material: brass chromium plated \varnothing 5 mm (FUF ...) | | |
| | | FUE 025B2011 FUF 025B2011 (length 25 cm) | 110 |
| | | FUE 050B2011 FUF 050B2011 (length 50 cm) | 100 |
| | | FUE 025B1011 FUF 025B1011 (length 25 cm) | 110 |
| | | FUE 050B1011 FUF 050B1011 (length 50 cm) | 100 |
| | | FUE 025B4004 FUF 025B4002 (length 25 cm) | 110 |
| | | FUE 050B4004 FUF 050B4002 (length 50 cm) | 100 |
| Fiber diameter 2 x 3 mm ² | | Part number | TW = sensing distance [mm] |
| Sheath material: PUR \varnothing 6 mm (FUE ...) | Sheath material: brass chromium plated \varnothing 6 mm (FUF ...) | | |
| | | FUE 025B2008 FUF 025B2002 (length 25 cm) | 210 |
| | | FUE 050B2008 FUF 050B2002 (length 50 cm) | 200 |
| | | FUE 025B1008 FUF 025B1002 (length 25 cm) | 210 |
| | | FUE 050B1008 FUF 050B1002 (length 50 cm) | 200 |
| | | FUE 025B3001 FUF 025B3001 (length 25 cm) | 210 |
| | | FUE 050B3001 FUF 050B3001 (length 50 cm) | 200 |
| Fiber diameter 2 x 4 mm ² | | Part number | TW = sensing distance [mm] |
| Sheath material: PUR \varnothing 6 mm (FUE ...) | Sheath material: brass chromium plated \varnothing 6 mm (FUF ...) | | |
| | | FUE 025B2001 FUF 025B2001 (length 25 cm) | 240 |
| | | FUE 050B2001 FUF 050B2001 (length 50 cm) | 230 |
| | | FUE 025B1001 FUF 025B1001 (length 25 cm) | 240 |
| | | FUE 050B1001 FUF 050B1001 (length 50 cm) | 230 |

Glass fiber optics for Series 15

Through beam types

Series 15

| Fiber diameter 2 x 1 mm ² | | Part number | Sb = actual range [mm] |
|---|---|--|------------------------|
| Sheath material: PVC ø 2,5 mm (FSE ...) | Sheath material: brass chromium plated ø 4 mm (FSF ...) | | |
| | * can not be bent | FSE 025B2002 FSF 025B2002 (length 25 cm) | 140 |
| | | FSE 050B2002 FSF 050B2002 (length 50 cm) | 320 |
| | * can not be bent | FSE 025B2001 FSF 025B2005 (length 25 cm) | 140 |
| | | FSE 050B2001 FSF 050B2005 (length 50 cm) | 320 |
| | * can not be bent | FSE 025B1001 FSF 025B1005 (length 25 cm) | 140 |
| | | FSE 050B1001 FSF 050B1005 (length 50 cm) | 320 |
| | | FSE 025B4003 FSF 025B4003 (length 25 cm) | 140 |
| | | FSE 050B4003 FSF 050B4003 (length 50 cm) | 320 |
| Fiber diameter 2 x 2 mm ² | | Part number | Sb = actual range [mm] |
| Sheath material: PUR ø 4,5 mm (FSE ...) | Sheath material: brass chromium plated ø 5 mm (FSF ...) | | |
| | | FSE 025B2006 FSF 025B2006 (length 25 cm) | 160 |
| | | FSE 050B2006 FSF 050B2006 (length 50 cm) | 450 |
| | | FSE 025B1007 FSF 025B1007 (length 25 cm) | 160 |
| | | FSE 050B1007 FSF 050B1007 (length 50 cm) | 450 |
| | | FSE 025B4006 FSF 025B4002 (length 25 cm) | 160 |
| | | FSE 050B4006 FSF 050B4002 (length 50 cm) | 450 |

Through beam types

Glass fiber optics

Glass fiber optics for Series 15 Through beam types

Series 15

Through beam types

Glass fiber optics

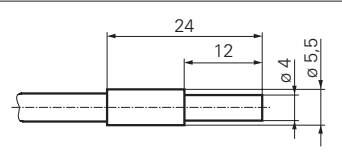
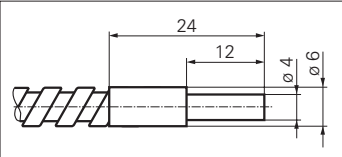
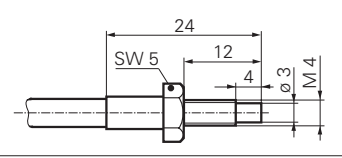
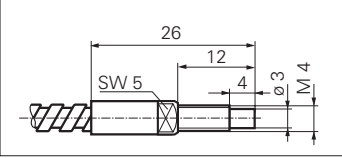
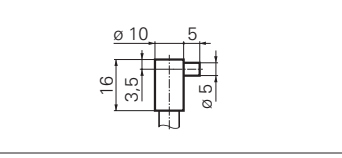
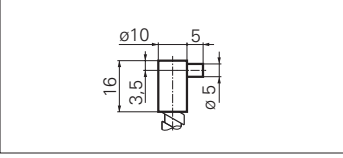



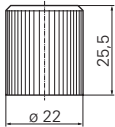
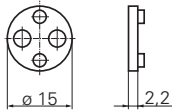
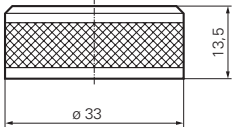
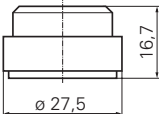

| Fiber diameter 2 x 4 mm ² | | Part number | Sb = actual range [mm] |
|---|---|--|------------------------|
| Sheath material: PVC ø 4 mm (FSE ...) | Sheath material: brass chromium plated ø 5 mm (FSF ...) | | |
|  |  | FSE 025B2003 FSF 025B2001 (length 25 cm) | 160 |
|  |  | FSE 025B1003 FSF 025B1001 (length 25 cm) | 160 |
|  |  | FSE 025B4004 FSF 025B4004 (length 25 cm) | 160 |
| | | FSE 050B2003 FSF 050B2001 (length 50 cm) | 500 |
| | | FSE 050B1003 FSF 050B1001 (length 50 cm) | 500 |
| | | FSE 050B4004 FSF 050B4004 (length 50 cm) | 500 |

Accessories fiber optics

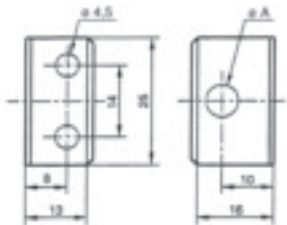
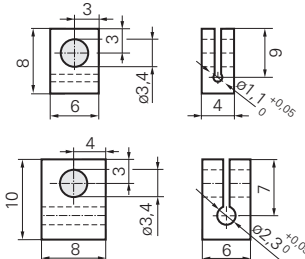
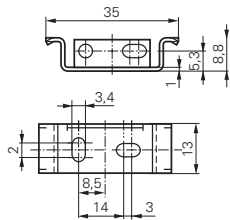
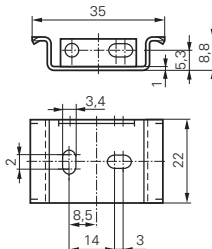
| | | |
|---|--|--|
| Focusing lens M3 | Focusing lens M3 | Focusing lens M3 |
| | | |
| Part number 134544 Light spot \varnothing 0,1 mm at a distance of 4,6 mm For fiber optic: FCE 050C1Y10 (recommended) FCE 200D1Y00 FCE 200E1Y00 FCE 200D1Y01 | Part number 134543 Light spot \varnothing 0,4 mm at a distance of 7 mm For fiber optic: FCE 050C1Y10 FCE 200E1Y00 FCE 200D1Y00 FCE 200D1Y01 | Part number 134542 Light spot \varnothing 2 mm at a distance of 19 mm For fiber optic: FCE 050C1Y10 FCE 200E1Y00 FCE 200D1Y00 FCE 200D1Y01 |
| Focusing lens M3 (pair) | Focusing lens M4 (pair) | |
| | | |
| Part number 119910 Increases the actual range S_b by a factor of 6 For fiber optic: FSE 200C1004 | Part number 119909 Increases the actual range S_b by a factor of 6 For fiber optic: FSE 200C1002 | |
| Focusing lens M2.6 (pair) | Focusing lens M2.6 (pair) | |
| | | |
| Part number 134541 Increases the actual range S_b by a factor of 6 For fiber optic: FSE 200C1Y00 / FSE 200C2Y00 FSA 200C1Y00 FSE 200E1Y00 FSG 200C1Y00 | Part number 134540 Side light exit Increases the actual range S_b by a factor of 6 For fiber optic: FSE 200C1Y00 / FSE 200C2Y00 FSG 200C1Y00 FSA 200C1Y00 FSE 200E1Y00 | |

Accessories fiber optics

| | | |
|--|--|--|
| <p>Cap nut Serie 15</p> | <p>Cap nut Serie 18</p> | <p>Adjusting plate Serie 18</p> |
|  |  |  |
| <p>Part number 103230 - for re-orders when lost - enclosed with every fiber optic of Serie 15</p> | <p>Part number 101480 - for re-orders when lost - enclosed with every fiber optic of Serie 18</p> | <p>Part number 101958 - for re-orders when lost - enclosed with every fiber optic of Serie 18</p> |
| <p>Cap nut Serie 30</p> | <p>Adapter Serie 30</p> | |
|  |  | |
| <p>Part number 102801 - must be ordered with every fiber optic of Serie 30</p> | <p>Part number 102757 - must be ordered with every fiber optic of Serie 30</p> | |
| | | |
| | | |
| | | |



| | | |
|--|---|---|
| <p>Mounting bracket</p> | <p>Mounting bracket</p> | <p>Mounting bracket</p> |
|  |  |  |
| <p>Part number 134532 for sensing head M3 øA 3,5 mm 134536 for sensing head M4 øA 4,5 mm 134538 for sensing head M6 øA 6,5 mm</p> | <p>Part number 119912 For fiber optic through beam type with 1,1 mm sheath diameters 119911 For fiber optic through beam type with 2,2 mm sheath diameters</p> | <p>Part number 145702 For Series 12 fiber optic sensors Delivered with every plastic fiber optic sensor</p> |
| <p>Mounting bracket</p> | <p>Mounting bracket</p> | <p>Reduction tube</p> |
|  |  |  |
| <p>Part number 125534 For Series 22 fiber optic sensors Delivered with every plastic fiber optic sensor.</p> | <p>Part number 159806 Delivered with every Series 69, Series 60, Series 80 fiber optic sensor. The mounting bracket must be ordered separately for Series 67 sensors.</p> | <p>Part number 140260 Set of 2 Delivered with every 1 mm diameter plastic fiber optic.</p> |
| <p>Fiber optic cable extension</p> | <p>Fiber optic extension</p> | <p>Cutting tool</p> |
|  |  |  |
| <p>Part number 145523 Länge: 5 m Highly flexible fiber Reduction in range due to fiber optic extension: approx. 25 %</p> | <p>Part number 156738 Länge: 2 m 158142 Länge: 5 m Reduction in range due to fiber optic extension: 2 m = approx. 25 % ; 5 m = approx. 60 %</p> | <p>Part number 114652 Delivered with every plastic fiber optic</p> |



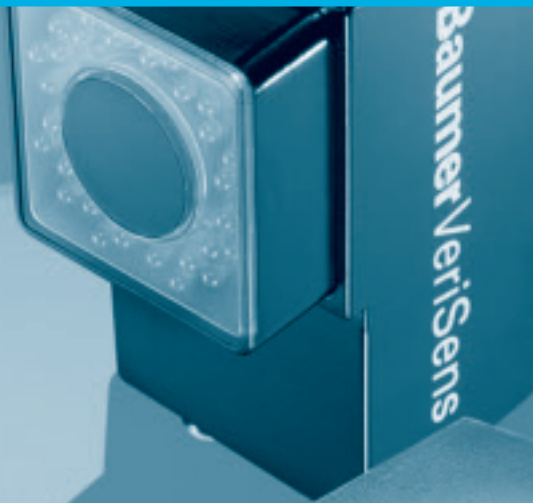

Vision sensors
Edge/Profile recognition





| product family | VXS 1203M10 | VXS 1203M16 | VXS 1003M10 |
|---------------------------|---|--|---|
| |  |  |  |
| | <i>VeriSens</i> | <i>VeriSens</i> | <i>VeriSens</i> |
| picture sensor | High Sensitive Progressive Scan CCD | High Sensitive Progressive Scan CCD | High Sensitive Progressive Scan CCD |
| pixel quantity | 656 x 494 | 656 x 494 | 656 x 494 |
| objectiv (focal distance) | 10 mm | 16 mm | 10 mm |
| min. object distance | 50 mm | 60 mm | 50 mm |
| lighting LED red | ■ | ■ | ■ |
| lighting LED white | ■ | ■ | ■ |
| signal processing | processor Baumer FEX® 3.0 64 MByte | processor Baumer FEX® 3.0 64 MByte | processor Baumer FEX® 3.0 64 MByte |
| communication seriell | setting up USB 2.0 process interface RS485 | setting up USB 2.0 process interface RS485 | USB 2.0 |
| housing material | aluminum and polycarbonat | aluminum and polycarbonat | aluminum and polycarbonat |
| | | | |
| Page | 500 | 501 | 502 |



| VXS 1003M16 | VXS 0501M10 |
|---|---|
|  |  |
| <i>VeriSens</i> | <i>VeriSens</i> |
| High Sensitive Progressive Scan CCD | CMOS |
| 656 x 494 | 320 x 240 |
| 16 mm | 10 mm |
| 60 mm | 50 mm |
| ■ | - |
| ■ | ■ |
| processor Baumer FEX® 3.0 64 MByte | processor Baumer FEX® 2.5 32 MByte |
| USB 2.0 | USB 2.0 |
| aluminum and polycarbonat | aluminum and polycarbonat |
| 503 | 504 |



General information

The new image-processing vision sensors *VeriSens*[®] from Baumer close the gap between classical optical sensors and complex vision systems. Their high-resolution image sensor permits 2-dimensional, i.e. arial inspection of objects. For this purpose, *VeriSens*[®] vision sensors offer extensive functions, thus supporting numerous inspection tasks in automation technology.

Due to the innovative Baumer FEX[®] processor technology, Baumer *VeriSens*[®] vision sensors are characterized by an extremely compact design. They provide process reliability and user-friendliness unachieved in this class until today.

Applications

Completeness checking



Placement checking in the handling industry

The Baumer *VeriSens*[®] is a flexible solution for many sensor applications in automated production.

The *VeriSens*[®] offers an extensive library of pre-configured functions for this purpose. You can define the job of your *VeriSens*[®] according to your requirements. The parameters are simply set with the configuration software on a PC.

Presence checking



Seal checking and inspection of labels in the packaging industry

Within the shortest time you can reliably implement simple presence checks up to extensive 100% inspections of several object properties simultaneously. Several jobs can be loaded into a *VeriSens*[®]. The current job is selected automatically via digital inputs by a PLC or manually by the operator. This also permits the switching between different jobs when changing products subjected to inspection.

Once the parameters have been set, the *VeriSens*[®] operates completely autonomously and reliably – just like a sensor should!

Location and position detection

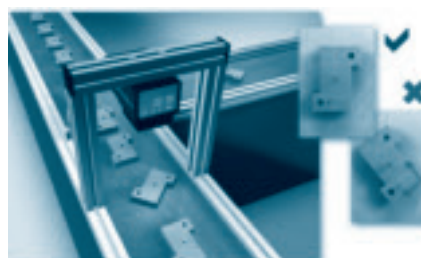

Detection of the correct position of objects in material handling

Characteristics and advantages

- Pre-configured sensor functions support many inspection tasks
- Position correction functions in the x, y and rotation directions allow for reliable operation even with varying position of the inspected specimen
- Inspection tasks can be selected by digital inputs
- Compact design with integrated LED illumination, precision optics and processing electronics



Technology and operation

The *VeriSens*[®] is equipped with integrated LED illumination, precision optics, a CCD camera, processing electronics and interfaces, all contained in a very compact, rugged aluminum housing. This permits stand-alone operation without additional external modules.

The Baumer FEX[®] image processor calculates all object contours in a grey-value image in real-time and with subpixel accuracy, even at minimum brightness contrast.

The *VeriSens* Application Suite

Configuring a *VeriSens*[®] vision sensor easily takes place with the "Application Suite" control program on a PC or laptop.

The graphical user interface of the Application Suite is characterized by a straightforward user guidance. It also provides intuitive support for people not specialized in setting up an image processing application. Apart from the actual inspection function, *VeriSens*[®] can also be connected conveniently to a PLC.

Numerous additional functions are available to the professional, such as functions otherwise offered by expensive vision systems only. These functions include the detection of image sequences in real-time for offline parameter setting of the sensors, the convenient management of configuration data, the visualization of statistical data and the

Application Suite VeriSens v1.0.

- VeriSens
- ✓ Job
- ✓ Image
- Sensors
- ✓ Output
- ✓ Test
- Activate VeriSens

Intuitive user guidance

Fast live image display in high-quality resolution

State

Device: VXS 1003M-10160106

Mode: Run-Online

Job: New job

Result: OK Alarm 29,7 ms

Statistics

| | | |
|-------|-------|--------------|
| Parts | 3.964 | 29,7 parts/s |
| OK | 3.964 | 100,00 % |
| Alarm | 0 | 0,00 % |

Status and statistical data display for process monitoring

Simple parameter setting of the sensor functions with a clearly arranged interface.

Configure "Edge 1" (Edge)

Parameter Name / Comment Arrow Teach

Distance 35 Pixel Min 0 Max 100

Alignment 88 Degree Min 90 Max 100

Sensor type: Edge

Short Low contrast

OK Alarm

Alignment adjustment

Alignment

Delete New

Baumer VeriSens[®]

Support Info Help

Contrast sensor

The contrast sensor measures the contrast in a working area and compares the result with the specified thresholds.

Min 85 Max 255

Comprehensive help text for each function

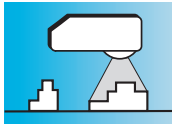

focal distance = 10 mm

- Outline function and Outline comparison
- Brightness, Contrast and Blob



general data

| | |
|---------------------------|-------------------------------------|
| picture sensor | High Sensitive Progressive Scan CCD |
| pixel quantity | 656 x 494 |
| version | monochromatic |
| speed | |
| high resolution mode: | max. 30 inspections/sec |
| high speed mode: | max. 50 inspections/sec |
| objectiv (focal distance) | 10 mm |
| min. object distance | 50 mm |

inspection field

| | |
|---------------------------|--------------|
| at 60 mm object distance | 24 x 18 mm |
| at 100 mm object distance | 43 x 32 mm |
| at 200 mm object distance | 92 x 69 mm |
| at 300 mm object distance | 140 x 106 mm |

| | |
|----------------------|--|
| signal processing | processor Baumer FEX® 3.0 64 MByte |
| inputs | 8 ... 30 VDC |
| outputs | PNP 100 mA |
| 4x input digital | Trigger, job options 1 + 2, job option 3 / external Teach |
| 4x output digital | Pass / Fail, Ready, Alarm, Flash sync |
| communication serial | setting up USB 2.0 process interface RS485 |

electrical data

| | |
|--------------------------|--------------|
| voltage supply range +Vs | 8 ... 30 VDC |
| power consumption max. | typ. 6 W |

mechanical data

| | |
|------------------|----------------------------|
| width / diameter | 48 mm |
| height / length | 94 mm |
| depth | 49,5 mm |
| type | rectangular |
| housing material | aluminum and polycarbonate |
| weight | 250 g |

ambient conditions

| | |
|-----------------------|-----------------------------|
| operating temperature | +5 ... +50 °C |
| humidity | 0 ... 90 % (non-condensing) |
| protection class | IP 64 |

accessories

| | |
|--------------------------------------|--------|
| mounting bracket straight | 159905 |
| mounting bracket angular | 159906 |
| USB cable | 159907 |
| VeriSens application suite CD | 159908 |
| for details, see accessories section | |

dimension drawing

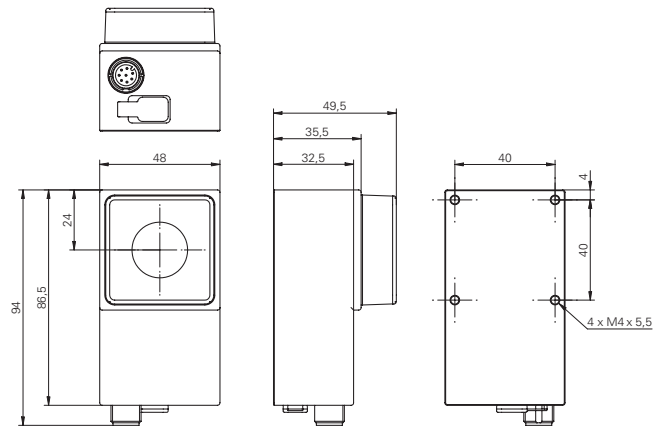

SPS-Interface Typ M12

- 1: IN1 (Trigger)
- 2: Power +24 VDC
- 3: OUT1 (Ready)
- 4: OUT2 (Pass / Fail)
- 5: OUT3 (Alarm)
- 6: IN2 (Job)
- 7: Ground
- 8: IN3 (Job)



SPS-Interface Typ M12

- 1: OUT4 (Flash)
- 2: IN4 (Job / Teach)
- 3: Ground
- 4: RS485+
- 5: RS485-

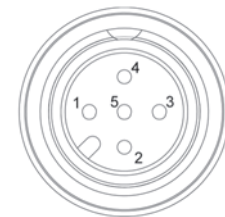

connectors

| | | |
|---------------|-------|-------------------------|
| ESG 34FP0200B | 8 pin | 2 m straight (shielded) |
| ESG 34FP0500B | 8 pin | 5 m straight (shielded) |
| ES 34CP2B | 5 pin | 2 m straight (shielded) |
| ES 34CP5B | 5 pin | 5 m straight (shielded) |

additional cable connectors and field wireable connectors, see accessories

order reference lighting

| | |
|---------------|-----------------------|
| VXS 1203M10RR | LED red (typ. 660 nm) |
| VXS 1203M10WR | LED white |

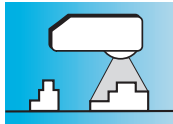

focal distance = 16 mm

- Outline function and Outline comparison
- Brightness, Contrast and Blob



| general data | |
|--------------------------------------|--|
| picture sensor | High Sensitive Progressive Scan CCD |
| pixel quantity | 656 x 494 |
| version | monochromatic |
| speed | |
| high resolution mode: | max. 30 inspections/sec |
| high speed mode: | max. 50 inspections/sec |
| objectiv (focal distance) | 16 mm |
| min. object distance | 60 mm |
| inspection field | |
| at 60 mm object distance | 13 x 10 mm |
| at 100 mm object distance | 25 x 19 mm |
| at 200 mm object distance | 55 x 42 mm |
| at 300 mm object distance | 86 x 64 mm |
| signal processing | processor Baumer FEX® 3.0 64 MByte |
| inputs | 8 ... 30 VDC |
| outputs | PNP 100 mA |
| 3x input digital | Trigger, job options 1 + 2, job option 3 / external Teach |
| 3x output digital | Pass / Fail, Ready, Alarm, Flash sync |
| communication serial | setting up USB 2.0 process interface RS485 |
| electrical data | |
| voltage supply range +Vs | 8 ... 30 VDC |
| power consumption max. | typ. 6 W |
| mechanical data | |
| width / diameter | 48 mm |
| height / length | 94 mm |
| depth | 49,5 mm |
| type | rectangular |
| housing material | aluminum and polycarbonate |
| weight | 250 g |
| ambient conditions | |
| operating temperature | +5 ... +50 °C |
| humidity | 0 ... 90 % (non-condensing) |
| protection class | IP 64 |
| accessories | |
| mounting bracket straight | 159905 |
| mounting bracket angular | 159906 |
| USB cable | 159907 |
| VeriSens application suite CD | 159908 |
| for details, see accessories section | |

| order reference | lighting |
|-----------------|-----------------------|
| VXS 1203M16RR | LED red (typ. 660 nm) |
| VXS 1203M16WR | LED white |

dimension drawing

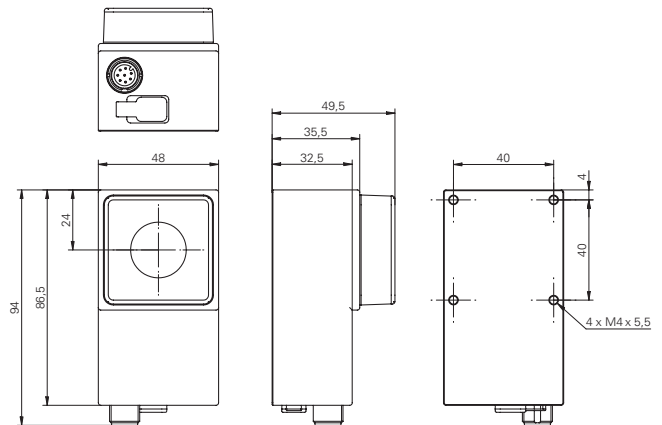

SPS-Interface

Typ M12

- 1: IN1 (Trigger)
- 2: Power +24 VDC
- 3: OUT1 (Ready)
- 4: OUT2 (Pass / Fail)
- 5: OUT3 (Alarm)
- 6: IN2 (Job)
- 7: Ground
- 8: IN3 (Job)



SPS-Interface

Typ M12

- 1: OUT4 (Flash)
- 2: IN4 (Job / Teach)
- 3: Ground
- 4: RS485+
- 5: RS485-

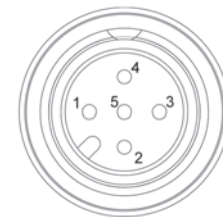

connectors

| | | |
|--|-------|-------------------------|
| ESG 34FP0200B | 8 pin | 2 m straight (shielded) |
| ESG 34FP0500B | 8 pin | 5 m straight (shielded) |
| ES 34CP2B | 5 pin | 2 m straight (shielded) |
| ES 34CP5B | 5 pin | 5 m straight (shielded) |
| additional cable connectors and field wireable connectors, see accessories | | |

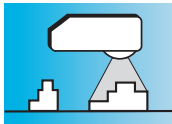

focal distance = 10 mm

- Outline function and Outline comparison
- Brightness, Contrast and Blob



general data

| | |
|---------------------------|-------------------------------------|
| picture sensor | High Sensitive Progressive Scan CCD |
| pixel quantity | 656 x 494 |
| version | monochromatic |
| speed | |
| high resolution mode: | max. 30 inspections/sec |
| high speed mode: | max. 50 inspections/sec |
| objectiv (focal distance) | 10 mm |
| min. object distance | 50 mm |

inspection field

| | |
|---------------------------|--------------|
| at 60 mm object distance | 24 x 18 mm |
| at 100 mm object distance | 43 x 32 mm |
| at 200 mm object distance | 92 x 69 mm |
| at 300 mm object distance | 140 x 106 mm |

| | |
|----------------------|--|
| signal processing | processor Baumer FEX® 3.0 64 MByte |
| inputs | 8 ... 30 VDC |
| outputs | PNP 100 mA |
| 3x input digital | Trigger, job options 1 + 2 |
| 3x output digital | Pass / Fail, Ready Alarm / Flash sync |
| communication serial | USB 2.0 |

electrical data

| | |
|--------------------------|--------------|
| voltage supply range +Vs | 8 ... 30 VDC |
| power consumption max. | typ. 6 W |

mechanical data

| | |
|------------------|----------------------------|
| width / diameter | 48 mm |
| height / length | 94 mm |
| depth | 49,5 mm |
| type | rectangular |
| housing material | aluminum and polycarbonate |
| weight | 250 g |

ambient conditions

| | |
|-----------------------|-----------------------------|
| operating temperature | +5 ... +50 °C |
| humidity | 0 ... 90 % (non-condensing) |
| protection class | IP 64 |

accessories

| | |
|-------------------------------|--------|
| mounting bracket straight | 159905 |
| mounting bracket angular | 159906 |
| USB cable | 159907 |
| VeriSens application suite CD | 159908 |

for details, see accessories section

order reference

| | |
|----------------------|-----------------------|
| VXS 1003M10RS | LED red (typ. 660 nm) |
| VXS 1003M10WS | LED white |

lighting

dimension drawing

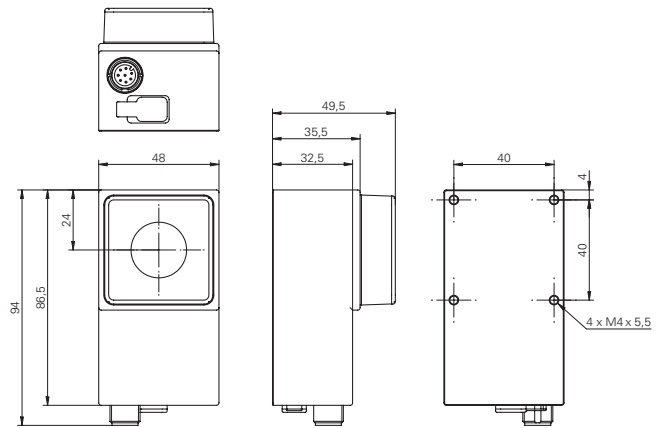

SPS-Interface

- 1: IN1 (Trigger)
- 2: Power +24 VDC
- 3: OUT1 (Ready)
- 4: OUT2 (Pass / Fail)
- 5: OUT3 (Flash / Alarm)
- 6: IN2 (Job)
- 7: Ground
- 8: IN3 (Job)

Typ M12



connectors

| | | |
|---------------|-------|--------------------------|
| ESG 34FP0200B | 8 pin | 2 m straight (shielded) |
| ESG 34FP0500B | 8 pin | 5 m straight (shielded) |
| ESG 34FP1000B | 8 pin | 10 m straight (shielded) |
| ESW 33FP1000B | 8 pin | 10 m angular (shielded) |

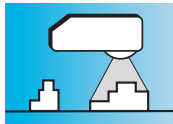

focal distance = 16 mm

- Outline function and Outline comparison
- Brightness, Contrast and Blob



| general data | |
|--------------------------------------|--|
| picture sensor | High Sensitive Progressive Scan CCD |
| pixel quantity | 656 x 494 |
| version | monochromatic |
| speed | |
| high resolution mode: | max. 30 inspections/sec |
| high speed mode: | max. 50 inspections/sec |
| objectiv (focal distance) | 16 mm |
| min. object distance | 60 mm |
| inspection field | |
| at 60 mm object distance | 13 x 10 mm |
| at 100 mm object distance | 25 x 19 mm |
| at 200 mm object distance | 55 x 42 mm |
| at 300 mm object distance | 86 x 64 mm |
| signal processing | processor Baumer FEX® 3.0 64 MByte |
| inputs | 8 ... 30 VDC |
| outputs | PNP 100 mA |
| 3x input digital | Trigger, job options 1 + 2 |
| 3x output digital | Pass / Fail, Ready Alarm / Flash sync |
| communication seriell | USB 2.0 |
| electrical data | |
| voltage supply range +Vs | 8 ... 30 VDC |
| power consumption max. | typ. 6 W |
| mechanical data | |
| width / diameter | 48 mm |
| height / length | 94 mm |
| depth | 49,5 mm |
| type | rectangular |
| housing material | aluminum and polycarbonate |
| ambient conditions | |
| operating temperature | +5 ... +50 °C |
| humidity | 0 ... 90 % (non-condensing) |
| protection class | IP 64 |
| accessories | |
| mounting bracket straight | 159905 |
| mounting bracket angular | 159906 |
| USB cable | 159907 |
| <i>VeriSens</i> application suite CD | 159908 |
| for details, see accessories section | |

dimension drawing

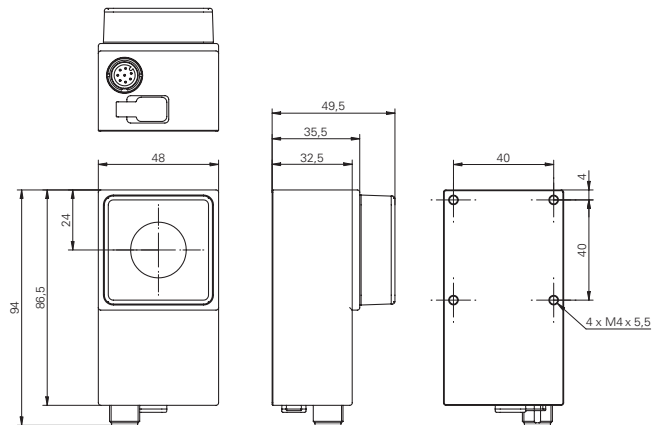

SPS-Interface

Typ M12

- 1: IN1 (Trigger)
- 2: Power +24 VDC
- 3: OUT1 (Ready)
- 4: OUT2 (Pass / Fail)
- 5: OUT3 (Flash / Alarm)
- 6: IN2 (Job)
- 7: Ground
- 8: IN3 (Job)



connectors

| | | |
|---------------|-------|--------------------------|
| ESG 34FP0200B | 8 pin | 2 m straight (shielded) |
| ESG 34FP0500B | 8 pin | 5 m straight (shielded) |
| ESG 34FP1000B | 8 pin | 10 m straight (shielded) |
| ESW 33FP1000B | 8 pin | 10 m angular (shielded) |

| order reference | lighting |
|-----------------|-----------------------|
| VXS 1003M16RS | LED red (typ. 660 nm) |
| VXS 1003M16WS | LED white |

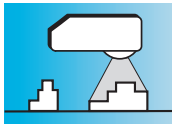

focal distance = 10 mm

- Outline function and Outline comparison
- Brightness, Contrast and Blob



general data

| | |
|---------------------------|-------------------------|
| picture sensor | CMOS |
| pixel quantity | 320 x 240 |
| version | monochromatic |
| speed | max. 50 inspections/sec |
| objectiv (focal distance) | 10 mm |
| min. object distance | 50 mm |

inspection field

| | |
|---------------------------|-------------|
| at 60 mm object distance | 22 x 14 mm |
| at 100 mm object distance | 40 x 25 mm |
| at 200 mm object distance | 85 x 55 mm |
| at 300 mm object distance | 130 x 83 mm |

signal processing processor Baumer FEX® 2.5
32 MByte

inputs 8 ... 30 VDC
outputs PNP 100 mA

3x input digital Trigger, job options 1 + 2

3x output digital Pass / Fail, Ready
Alarm / Flash sync

communication seriell USB 2.0

electrical data

| | |
|--------------------------|--------------|
| voltage supply range +Vs | 8 ... 30 VDC |
| power consumption max. | typ. 6 W |

mechanical data

| | |
|------------------|----------------------------|
| width / diameter | 48 mm |
| height / length | 94 mm |
| depth | 49,5 mm |
| type | rectangular |
| housing material | aluminum and polycarbonate |
| weight | 250 g |

ambient conditions

| | |
|-----------------------|-----------------------------|
| operating temperature | +5 ... +50 °C |
| humidity | 0 ... 90 % (non-condensing) |
| protection class | IP 64 |

accessories

| | |
|--------------------------------------|--------|
| mounting bracket straight | 159905 |
| mounting bracket angular | 159906 |
| USB cable | 159907 |
| VeriSens application suite CD | 159908 |
| for details, see accessories section | |

dimension drawing

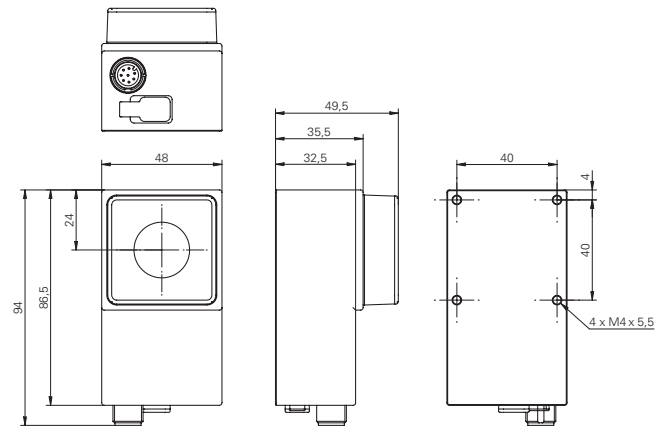

SPS-Interface Typ M12

- 1: IN1 (Trigger)
- 2: Power +24 VDC
- 3: OUT1 (Ready)
- 4: OUT2 (Pass / Fail)
- 5: OUT3 (Flash / Alarm)
- 6: IN2 (Job)
- 7: Ground
- 8: IN3 (Job)





connectors

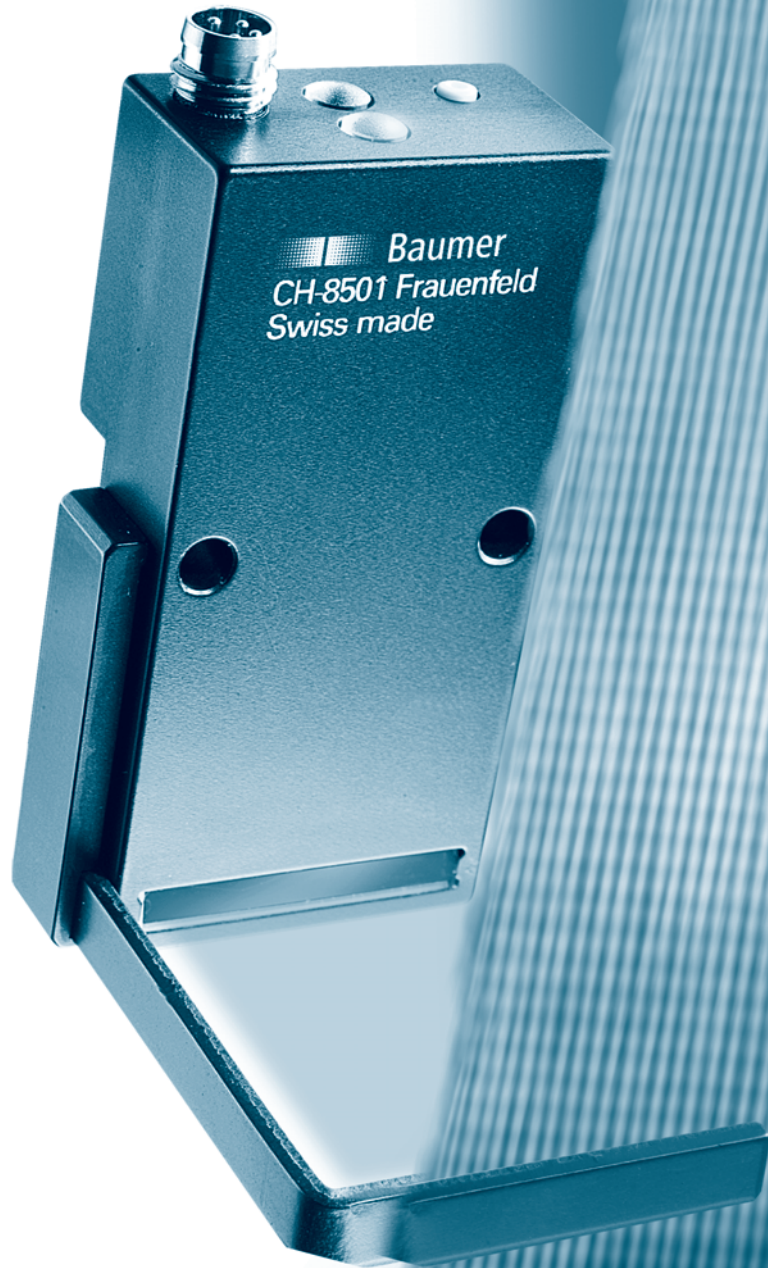

| | | |
|---------------|-------|--------------------------|
| ESG 34FP0200B | 8 pin | 2 m straight (shielded) |
| ESG 34FP0500B | 8 pin | 5 m straight (shielded) |
| ESG 34FP1000B | 8 pin | 10 m straight (shielded) |
| ESW 33FP1000B | 8 pin | 10 m angular (shielded) |

| order reference | lighting |
|-----------------|-----------|
| VXS 0501M10WS | LED white |





| product family | ZADM 034 | ZADM 034 |
|--------------------------------|---|---|
| |  |  |
| | <i>ParCon</i> | <i>ParCon</i> |
| measuring field size | 24 mm | 24 mm |
| measuring range towards object | 0 ... 40 mm | 0 ... 40 mm |
| measuring frequency | > 1000 Hz | > 4000 Hz |
| output signal | 4 ... 20 mA | |
| PNP | | ■ |
| analog | ■ | |
| connector | ■ | ■ |
| housing material | metal | metal |
| Page | 510 | 512 |

| product family | ZADM 023 | ZADM 023 |
|--|---|---|
| |  |  |
| | <i>PosCon</i> | <i>PosCon</i> |
| measuring field size | 30 mm 150 mm 350 mm | |
| measuring field size (dep. on measuring dist.) | | 400 ... 875 mm |
| measuring distance (to object) | 50 mm 200 mm 500 mm | |
| measuring range towards object | | 640 ... 1400 mm |
| measuring frequency | > 500 Hz | > 500 Hz |
| analog and RS 485 | ■ | ■ |
| output signal | 4 ... 20 mA | 4 ... 20 mA |
| connector | ■ | ■ |
| housing material | metal | metal |
| Page | 514 | 516 |



General information

Line sensors are used to detect object widths and object positions. The position / width is issued as an analog value with high accuracy proportional to the overall measuring area. Although smaller than a deck of playing cards, the sensors contain not only the complete signal conditioning, but also a long-life illumination unit.

The simple switching version of the *ParCon* also permits the detection of small objects within the measuring area.

Applications



Edge recognition (*PosCon*, *ParCon*)

- Control of textile, plastic or paper edges
- Positioning of objects by the edge
- Level measurement

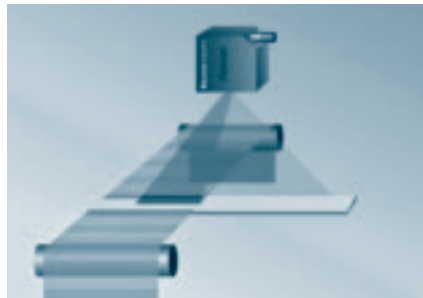

Width measurement (*PosCon*, *ParCon*)

- Width inspection during the production of fabric and rubber bands



Center position (*PosCon*)

- Position measurement by the object center, by which bands or objects of different width can be aligned centrally to each other

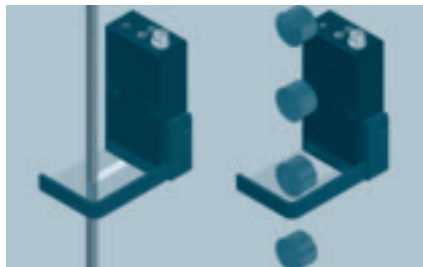

Counting and detecting objects (*ParCon*), switching output

- Detection and counting of small objects falling through the measurement area
- Wire and belt break monitoring



Characteristics and advantages

ParCon line sensor

- The two measuring modes (edge, center) can be set at the push of a button.
- Due to the parallel light beams, the vertical movement of fabric webs does not affect the measurement signal.
- The high measuring frequency of 1000 Hz in the analog sensor also permits rapid movements to be detected.
- Due to the high switching frequency of 4 kHz, even small, rapidly moving parts are reliably detected.

PosCon line sensor

- The measuring area can be restricted by a simple Teach-in process to suppress interfering objects and areas.
- The three different measuring modes (width, edge, center) can be set simply at the push of a button.
- Two threshold values can be programmed with the Teach-in button and serve as tolerance limits for the switching output.
- All functions available with the buttons can also be operated via an RS 485 interface.
- The position and other information can be read via the interface.
- Measurement is possible on transparent objects and films.

Technology and operation

With the line sensors, the light of the integrated illumination is reflected by a reflective film (special film) installed opposite the sensor and is received by the diode line. The length of the diode line and the optics determine the measuring area. Due to the narrow diode line, the measuring area is also only a narrow band. If an object obstructs a part of the light, no light falls on the corresponding part of the diode line. The integrated microcontroller processes the shaded areas and the transitions from dark to light and calculates the corresponding analog value according to the measuring mode.

The optics of the *PosCon* and the *ParCon* are constructed differently. The *PosCon* has a diverging measuring field. This makes large measuring areas of up to 800 mm possible. The specified measuring area is achieved at the nominal distance. It becomes larger or smaller proportionally with the distance. This causes an object to appear larger or smaller according to the distance.

The *ParCon* has a parallel measuring field, making an object appear equal in size in the entire measuring area.

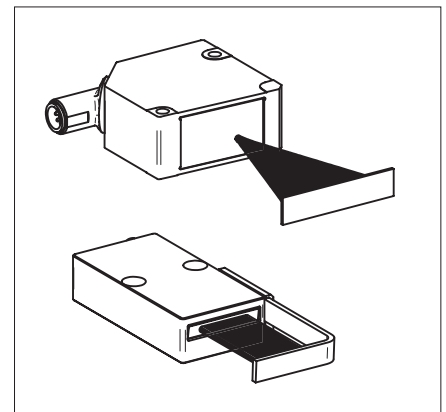

Mounting and adjustment

The reflective tape specified in the documentation must be used for the *PosCon* and *ParCon*.

If the reflective tape is protected against abrasion by a Plexiglas or glass sheet, this must be tilted 7° to the sensor to ensure that the direct reflection does not reflect to the receiver. The reflective tape for the *ParCon* is covered by a protective film.

If highly reflective objects are measured, it is conceivable that a direct reflection will occur just as strong as the light from the reflective film. In this case, measuring errors can occur. This can be prevented by tilting the object away from the sensor.

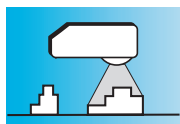

measuring range = 0 ... 40

- measuring of edge position and object width
- parallel, uniform light beam
- high measuring frequency

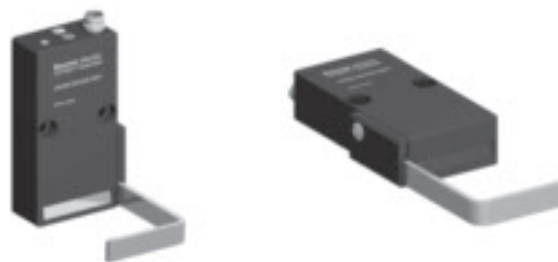

general data

| | |
|--------------------------------|---|
| measuring field size | 24 mm |
| measuring range towards object | 0 ... 40 mm |
| measuring frequency | > 1000 Hz |
| resolution | < 0,05 mm |
| smallest object recognizable | 1 mm |
| linearity error | ± 0,4 mm (S = 0...40 mm) ± 0,2 mm (S = 20...40 mm) |
| repeatability | < 0,05 mm |
| power on indication | LED green |
| output indicator | LED yellow |
| light source | pulsed infrared diode |
| wave length | 880 nm |

electrical data

| | |
|-----------------------------|----------------|
| response time | < 1 ms |
| voltage supply range +Vs | 12 ... 28 VDC |
| current consumption max. | 120 mA |
| output circuit | analog |
| output signal | 4 ... 20 mA |
| reverse polarity protection | yes, Vs to GND |
| short circuit protection | yes |

mechanical data

| | |
|------------------|---------------------|
| housing material | aluminum |
| front (optics) | glass |
| connection types | connector M8, 4 pin |

ambient conditions

| | |
|-----------------------|--------------|
| operating temperature | 0 ... +55 °C |
| protection class | IP 67 |

order reference **type**

| | |
|-------------------|-------------------------|
| ZADM 034I240.0001 | rectangular, side view |
| ZADM 034I240.0021 | rectangular, front view |

connection diagram

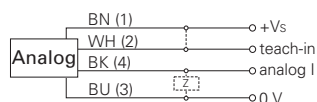

connectors

| | | |
|---------------|-------|-------------------------|
| ESG 32AP0500G | 4 pin | 5 m straight (shielded) |
| ESW 31AP0500G | 4 pin | 5 m angular (shielded) |

additional cable connectors and field wireable connectors, see accessories

ZADM 034 measuring range = 0 ... 40 mm

Line sensors ParCon

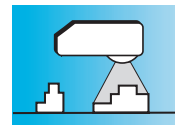

reflectors

| | |
|-----------------|--|
| FTDF 012M050 | tape 12 x 50 mm (included) |
| FTDR 008M030/01 | bracket for ZADM 034x240.xx01 (included) |
| FTDR 008M030/21 | bracket for ZADM 034x240.xx21 (included) |

optional

| | |
|--------------|------------------|
| FTDF 050M234 | tape 50 x 234 mm |
|--------------|------------------|

dimension drawings

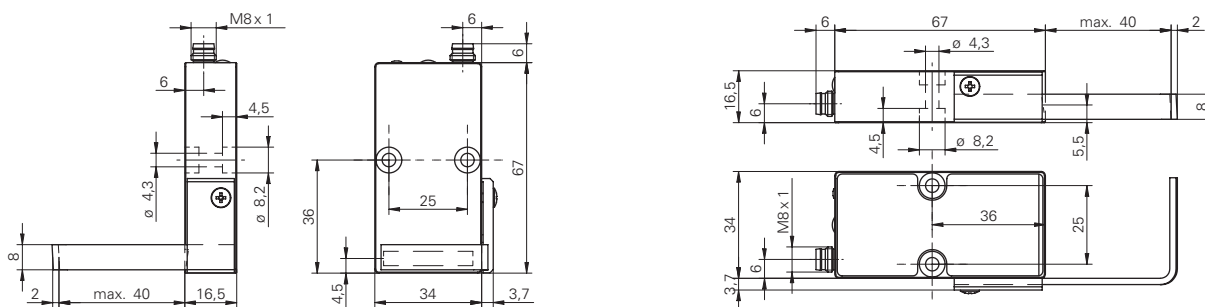

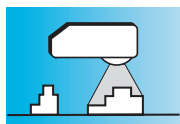

measuring range = 0 ... 40

- detection of small objects
- measuring area 24 x 40 mm
- high measuring frequency

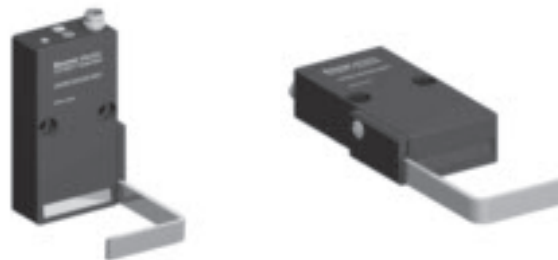

general data

| | |
|--------------------------------|-----------------------|
| measuring field size | 24 mm |
| measuring range towards object | 0 ... 40 mm |
| measuring frequency | > 4000 Hz |
| resolution | < 0,1 mm |
| smallest object recognizable | 0,5 mm |
| hysteresis | 0,4 mm |
| power on indication | LED green |
| light source | pulsed infrared diode |
| wave length | 880 nm |
| adjustment | Teach-in |

electrical data

| | |
|-----------------------------|----------------------|
| response time | < 0,25 ms |
| output pulse length | 10 ms |
| voltage supply range +Vs | 12 ... 28 VDC |
| current consumption max. | 120 mA |
| output circuit | PNP |
| output current | < 100 mA |
| voltage drop Vd | < 2,2 VDC |
| reverse polarity protection | yes, Vs to GND |
| short circuit protection | yes |
| output function | light / dark operate |

mechanical data

| | |
|------------------|---------------------|
| housing material | aluminum |
| front (optics) | glass |
| connection types | connector M8, 4 pin |

ambient conditions

| | |
|-----------------------|--------------|
| operating temperature | 0 ... +55 °C |
| protection class | IP 67 |

order reference

type

| | |
|-------------------|-------------------------|
| ZADM 034P240.6901 | rectangular, side view |
| ZADM 034P240.6921 | rectangular, front view |

connection diagram

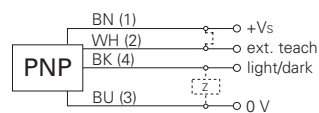

connectors

| | | |
|---------------|-------|-------------------------|
| ESG 32AP0500G | 4 pin | 5 m straight (shielded) |
| ESW 31AP0500G | 4 pin | 5 m angular (shielded) |

additional cable connectors and field wireable connectors, see accessories

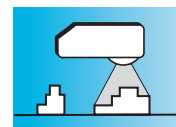

reflectors

| | |
|-----------------|--|
| FTDF 012M050 | tape 12 x 50 mm (included) |
| FTDR 008M030/01 | bracket for ZADM 034x240.xx01 (included) |
| FTDR 008M030/21 | bracket for ZADM 034x240.xx21 (included) |

optional

| | |
|--------------|------------------|
| FTDF 050M234 | tape 50 x 234 mm |
|--------------|------------------|

dimension drawings

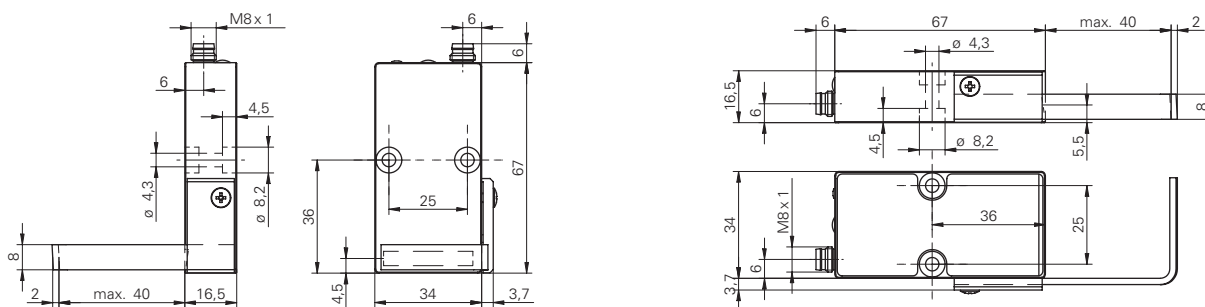

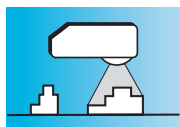

measuring field size = 350



- Teach-in measuring range
- measuring mode: edges, center, width
- RS 485 interface

general data

| | |
|--------------------------|-------------------------------------|
| version | with filter for transparent objects |
| measuring frequency | > 500 Hz |
| linearity error relative | < 0,3 % |
| light source | pulsed infrared diode |
| wave length | 880 nm |
| adjustment | Teach-in |

measuring field size = 30 mm

| | |
|--------------------------------|-----------|
| measuring distance (to object) | 50 mm |
| resolution | < 0,03 mm |
| smallest object recognizable | 0,3 mm |

measuring field size = 150 mm

| | |
|--------------------------------|-----------|
| measuring distance (to object) | 200 mm |
| resolution | < 0,15 mm |
| smallest object recognizable | 1,2 mm |

measuring field size = 350 mm

| | |
|--------------------------------|-----------|
| measuring distance (to object) | 500 mm |
| resolution | < 0,35 mm |
| smallest object recognizable | 4 mm |

electrical data

| | |
|-----------------------------|-------------------|
| voltage supply range +Vs | 15 ... 28 VDC |
| current consumption max. | 150 mA |
| output signal | 4 ... 20 mA |
| output current | < 100 mA |
| interface | analog and RS 485 |
| reverse polarity protection | yes, Vs to GND |
| short circuit protection | yes |

mechanical data

| | |
|------------------|---------------------------------|
| type | rectangular |
| housing material | die-cast zinc |
| front (optics) | glass |
| connection types | connector M12, 8 pin, rotatable |

ambient conditions

| | |
|-----------------------|--------------|
| operating temperature | 0 ... +55 °C |
| protection class | IP 67 |

connection diagrams

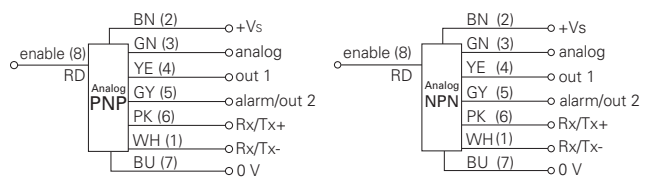

connectors

ESG 34FP0200B 8 pin 2 m straight (shielded)
 additional cable connectors and field wireable connectors, see accessories

accessories

mounting bracket 126220
 for details, see accessories section

| order reference | measuring field size | output function | switching output | reflector width |
|-------------------|----------------------|-----------------|------------------|-----------------|
| ZADM 023H151.0001 | 150 mm | Out 1 / Alarm | PNP | 15 mm |
| ZADM 023H151.0002 | 150 mm | Out 1 / Alarm | NPN | 15 mm |
| ZADM 023H151.0011 | 150 mm | Out 1 / Out 2 | PNP | 15 mm |
| ZADM 023H151.0012 | 150 mm | Out 1 / Out 2 | NPN | 15 mm |
| ZADM 023H300.0001 | 30 mm | Out 1 / Alarm | PNP | 3 mm |
| ZADM 023H300.0002 | 30 mm | Out 1 / Alarm | NPN | 3 mm |
| ZADM 023H300.0011 | 30 mm | Out 1 / Out 2 | PNP | 3 mm |
| ZADM 023H300.0012 | 30 mm | Out 1 / Out 2 | NPN | 3 mm |
| ZADM 023H351.0001 | 350 mm | Out 1 / Alarm | PNP | 30 mm |
| ZADM 023H351.0002 | 350 mm | Out 1 / Alarm | NPN | 30 mm |
| ZADM 023H351.0011 | 350 mm | Out 1 / Out 2 | PNP | 30 mm |
| ZADM 023H351.0012 | 350 mm | Out 1 / Out 2 | NPN | 30 mm |

ZADM 023 measuring field size = 350 mm

Line sensors *PosCon*

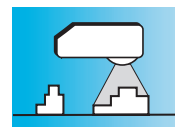

| reflectors | | | | | | |
|-----------------|--------|--------------|---------------------------|--------------|-----------------|--------------|
| | | reflector | reflector tape on reel | | reflective tape | |
| measuring range | 30 mm | FTDR 005I040 | FTDL 005I000/... m | width 5 mm | FTDF 005I040 | 5 x 40 mm |
| measuring range | 150 mm | FTDR 020I175 | FTDL 020I000/... m | width 20 mm | FTDF 020I175L | 20 x 17,5 mm |
| measuring range | 350 mm | FTDR 035I395 | FTDL 035I000/... m | width 35 mm | FTDF 035I395 | 35 x 395 mm |
| | | | FTDL 610I000/... m | width 610 mm | | |

dimension drawing

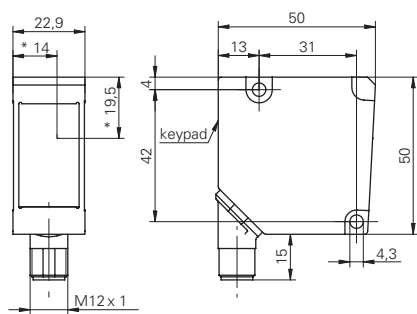

* receiver axis

ZADM 023 measuring field size = 350 mm

Line sensors *PosCon*

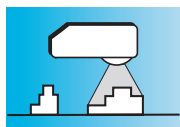

measuring field size = 875

- Teach-in measuring range
- measuring mode: edges, center, width
- RS 485 interface



general data

| | |
|--|--|
| version | without filter for transparent objects |
| measuring field size (dep. on measuring dist.) | 400 ... 875 mm |
| measuring range towards object | 640 ... 1400 mm |
| measuring frequency | > 500 Hz |
| resolution | 0,5 ... 1 mm |
| smallest object recognizable | 8,5 ... 18 mm |
| linearity error relative | < 0,3 % |
| light source | pulsed infrared diode |
| wave length | 880 nm |
| adjustment | Teach-in |

electrical data

| | |
|-----------------------------|-------------------|
| voltage supply range +Vs | 15 ... 28 VDC |
| current consumption max. | 150 mA |
| output signal | 4 ... 20 mA |
| output current | < 100 mA |
| interface | analog and RS 485 |
| reverse polarity protection | yes, Vs to GND |
| short circuit protection | yes |

mechanical data

| | |
|------------------|---------------------------------|
| type | rectangular |
| housing material | die-cast zinc |
| reflector width | 50 mm |
| front (optics) | glass |
| connection types | connector M12, 8 pin, rotatable |

ambient conditions

| | |
|-----------------------|--------------|
| operating temperature | 0 ... +55 °C |
| protection class | IP 67 |

connection diagrams

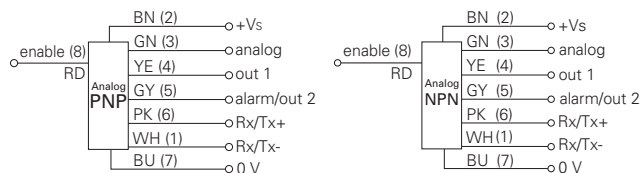

connectors

ESG 34FP0200B 8 pin 2 m straight (shielded)
 additional cable connectors and field wireable connectors, see accessories

accessories

mounting bracket 126220
 for details, see accessories section

| order reference | output function | switching output |
|-------------------|-----------------|------------------|
| ZADM 023H871.0001 | Out 1 / Alarm | PNP |
| ZADM 023H871.0002 | Out 1 / Alarm | NPN |
| ZADM 023H871.0011 | Out 1 / Out 2 | PNP |
| ZADM 023H871.0012 | Out 1 / Out 2 | NPN |

ZADM 023 measuring field size = 875 mm

Line sensors *PosCon*

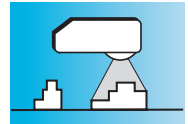

reflectors

| | |
|--------------------|-----------------------|
| FTDL 050I000/... m | on reel, width 35 mm |
| FTDL 610I000/... m | on reel, width 610 mm |
| included | |

conversion factors

| measuring distance (mm) | measuring range (mm) |
|------------------------------|----------------------|
| 640 | 400 |
| 1400 | 875 |
| meas. distance : meas. range | = 1,6 |

| measuring distance (mm) | resolution (mm) |
|-----------------------------|-----------------|
| 640 | 0,5 |
| 1400 | 1 |
| meas. distance : resolution | = 1300 |

| measuring distance (mm) | smallest object (mm) |
|----------------------------------|----------------------|
| 640 | 8,5 |
| 1400 | 18 |
| meas. distance : smallest object | = 75 |

| example | desired measuring range | = 650 mm |
|-----------------|-------------------------|-----------|
| meas. distance | 650 mm x 1,6 | = 1040 mm |
| resolution | 1040 mm : 1300 | = 0,8 mm |
| smallest object | 1040 mm : 75 | = 13,9 mm |

dimension drawing

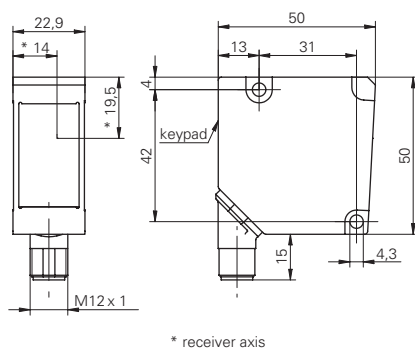

| product family | FLDM 170 | FLDM 170 | FLDK 110 | FLDK 110 |
|----------------------------|---|---|---|---|
| |  |  |  |  |
| | <i>SCATEC-15</i> | <i>SCATEC-10</i> | <i>SCATEC-2</i> | <i>SCATEC-J</i> |
| measuring distance Sd | 0 ... 120 mm | 0 ... 90 mm | 0 ... 60 mm | 0 ... 55 mm |
| optimum operating distance | 100 mm | 70 mm | 40 mm | 40 mm |
| counting rate | < 3'000'000 copies/h | < 3'000'000 copies/h | < 600'000 copies/h | < 280'000 copies/h |
| output pulse length | 0,3 ... 500 ms selectable | 0,3 ... 500 ms selectable | 5 / 10 / 15 / 20 ms selectable | 10 ms |
| sensitivity | single sheet/edge thickness 0,15 mm | single sheet/edge thickness 0,1 mm | single sheet/edge thickness 0,2 mm | single sheet/edge thickness 1,5 mm |
| false pulse suppression | 4 program options | 4 program options | on/off switchable | |
| sensitivity adjustment | 4 preset levels or level set by customer | 4 preset levels or level set by customer | high/low switchable | no |
| direct gap detection | yes | yes | | |
| interface | CAN and serial | serial | | |
| push-pull | ■ | ■ | ■ | ■ |
| opto isolated | ■ | ■ | ■ | |
| housing material | metal | metal | plastic | plastic |
| Page | 522 | 524 | 526 | 528 |



General information



The sensors in the **SCATEC** range were developed specifically for non-contact counting of overlapped paper sheets and newspapers. Other flat objects conveyed in a lap stream or individually can also be counted. If such an object moves through the laser beam, the sensor replies with an electrical impulse with a fixed time period. The patented optical principle permits objects to be detected regardless of their color and surface; matte black objects are counted just as accurately as white glossy ones.

Characteristics and advantages

- **Counts regardless of the direction of product motion**
The copies are counted when an edge facing the laser beam moves through the beam, whether the direction of product motion is forwards or backwards.
- **Visible laser beam**
The red laser line is easily visible on the object and permits simple alignment.
- **Color insensitivity**
The integrated laser controller makes the **SCATEC** extremely insensitive to different surfaces of the object.
- **No blind region**
Large counted objects can even touch the sensor without causing counting errors.
- **Sensitivity adjustment**
Depending on the model, the sensitivity can be adjusted with a DIP switch, on the control panel or via the interface.
- **Edge indicator**
Yellow LED: this lights as long as an edge is in the laser beam.



Characteristics and advantages

Multiple pulse suppression

Particularly with thick copies (newspapers, folded cardboard boxes etc.) or with a small prefold, multiple pulses which can occur at the edge can be suppressed by this function. Error pulse suppression operates by preventing further pulses from being emitted when an output pulse is active or during an idle time. The following programs guarantee optimum adjustment to all counting problems:

Fixed idle time: adjustable in milliseconds

Dynamic dead time: the microcontroller constantly monitors the pulse sequence and eliminates multiple pulses even if the conveying speed varies by dynamically adjusting the dead time to the pulse sequence.

Synchronization to the machine cycle: the **SCATEC** can be synchronized to the machine cycle (e.g. by an encoder) via a synchronization input. The dead time then corresponds to a defined distance which is absolutely independent of the conveying speed.

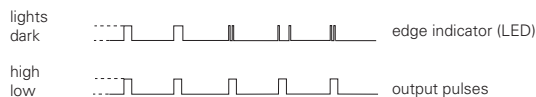
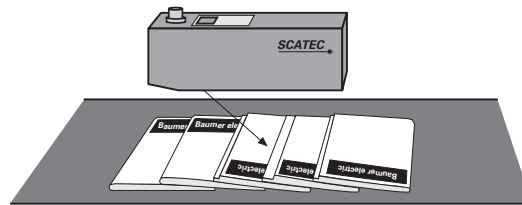

- No counting errors when the lap stream is interrupted

The **SCATEC** detects only the leading edge of an object. It does not detect trailing edges which become visible when the lap stream is interrupted. Projecting trailing edges can be suppressed by direct gap detection or by delaying the output pulse (**SCATEC-10** or **SCATEC-15**). An integrated retro-reflective sensor permits accurate detection of gaps in the lap stream. This can additionally increase the counting accuracy.

- Programming and diagnostic software

With the programming software **ScaDiag**, all functions and parameters can be simply adjusted on a PC. Furthermore, measurement sequences can be recorded and stored for diagnosis and troubleshooting.

- CAN interface

The **SCATEC-15** can be automatically programmed via the CAN interface (e.g. if the format is changed).



Technology and operation

Stated simply, the **SCATEC** consists of a laser light source and two photodetectors. The beam is aimed diagonally at the objects to be detected.

The photodetector **R** is located close to the laser light source and photodetector **V** is a little further away. The sensor determines the ratio between signal **v** (light diffused forwards) and signal **r** (light diffused backwards).

The ratio **v/r** differs widely depending on whether the beam strikes a flat surface or an edge. If an edge moves into the laser beam, the direct view from detector **V** to the laser strike point is obstructed, reducing signal **v**, and also the edge increases the backwards diffusion, which causes signal **r** to rise. Both effects make the ratio **v/r** much smaller at an edge than on a flat surface. If the ratio **v/r** falls below a specific threshold, this is interpreted by the sensor as an edge.

Due to the well-focused laser beam, the **SCATEC** detects even the smallest edges. There is no blind region directly beneath the sensor. Large counted objects may even touch the sensor without causing counting errors.

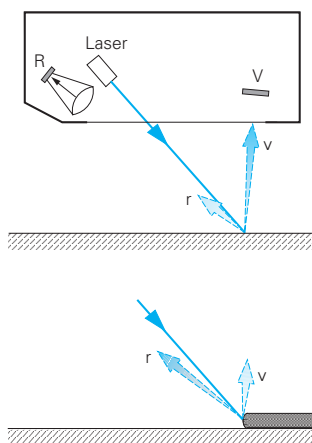

Mounting and adjustment

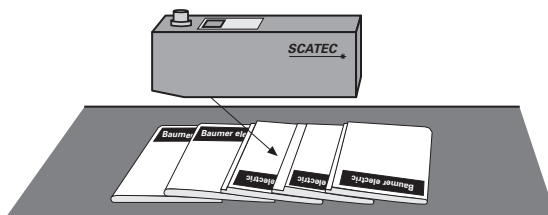

- The objects to be counted must have an edge facing the beam.
- The sensor must be installed parallel above the working plane.
- The laser beam should be blocked by a beam stop mounted parallel and just below the working plane. We recommend a light, matte object for this purpose (white paper, light and matte metal surface).

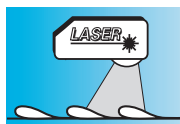

Sd = 0 ... 120 mm

- counting of up to 3 million copies/hour
- integrated copy counter
- CAN interface

general data

| | |
|----------------------------|--|
| measuring distance Sd | 0 ... 120 mm |
| optimum operating distance | 100 mm |
| counting rate | < 3'000'000 copies/h |
| object speed | < 5 m/sec |
| object cycle distance | > 1 mm |
| sensitivity | single sheet/edge thickness 0,15 mm |
| sync. input | yes |
| measuring point | visible red laser line 8 mm |
| light source | pulsed red laser diode |
| wave length | 670 nm |
| laser class | 2 |
| edge indicator | LED yellow |
| power on indication | LED green |
| direct gap detection | yes |
| false pulse suppression | 4 program options |
| sensitivity adjustment | 4 preset levels or level set by customer |

electrical data

| | |
|-----------------------------|---------------------------|
| voltage supply range +Vs | 10 ... 30 VDC |
| current consumption max. | 230 mA |
| output pulse length | 0,3 ... 500 ms selectable |
| short circuit protection | yes |
| reverse polarity protection | yes |
| interface | CAN and serial |

mechanical data

| | |
|---------------------------------|------------------|
| type | rectangular |
| housing material | die-cast zinc |
| connector base (main connector) | DIN 45322, 6 pin |
| connector base (interface) | DIN 45326, 8 pin |
| front (optics) | glass |

ambient conditions

| | |
|-----------------------|--------------|
| operating temperature | 0 ... +50 °C |
| protection class | IP 54 |

order reference

| order reference | output circuit |
|-------------------|----------------|
| FLDM 170C1030/S42 | opto isolated |
| FLDM 170G1030/S42 | push-pull |



connection diagrams

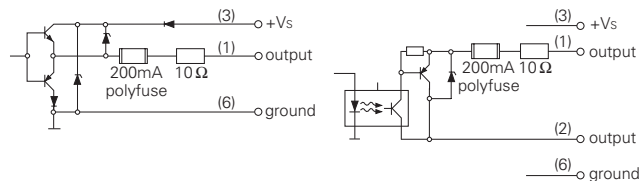

accessories

| | |
|--|--------|
| ScaDiag kit diagnostic program includes interface converter and manual | 156491 |
| mounting plate for mounting on rails | 157472 |

for details, see accessories section

laser warning



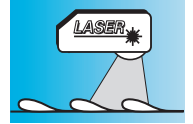

pin assignments

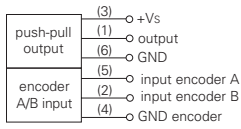

main connector push-pull

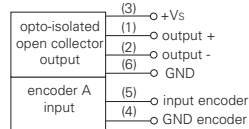

main connector open collector

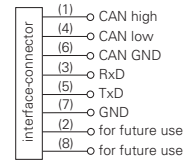

interface-connector

connectors

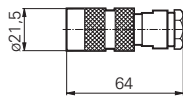

| | | |
|--------|-------|------------|
| 104236 | 6 pin | (included) |
| 153202 | 8 pin | (optional) |

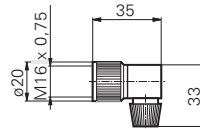

| | | |
|--------|-------|------------|
| 153094 | 6 pin | (optional) |
| 153095 | 8 pin | (optional) |

connector

| | |
|---------------|--------------------------|
| ESG 16FP1000G | CAN cable, length = 10 m |
|---------------|--------------------------|

reflectors

| | |
|--------------|-----------------|
| FTDF 025F025 | tape 25 x 25 mm |
| (included) | |

dimension drawing

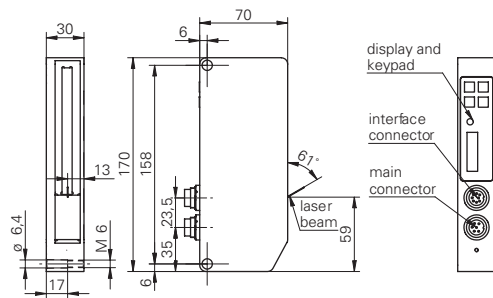

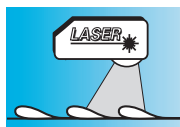

Sd = 0 ... 90 mm

- counting of up to 3 million copies/hour
- integrated copy counter

general data

| | |
|----------------------------|---------------------------------------|
| measuring distance Sd | 0 ... 90 mm |
| optimum operating distance | 70 mm |
| counting rate | < 3'000'000 copies/h |
| object speed | < 5 m/sec |
| object cycle distance | > 1 mm |
| sensitivity | single sheet/edge thickness 0,1 mm |
| sync. input | yes |
| measuring point | visible red laser line 6 mm |
| light source | pulsed red laser diode |
| wave length | 670 nm |
| laser class | 2 |
| edge indicator | LED yellow |
| power on indication | LED green |
| direct gap detection | yes |
| false pulse suppression | 4 program options |

electrical data

| | |
|-----------------------------|---------------------------|
| voltage supply range +Vs | 10 ... 30 VDC |
| current consumption max. | 230 mA |
| output pulse length | 0,3 ... 500 ms selectable |
| short circuit protection | yes |
| reverse polarity protection | yes |
| interface | serial |

mechanical data

| | |
|---------------------------------|------------------|
| type | rectangular |
| housing material | die-cast zinc |
| connector base (main connector) | DIN 45322, 6 pin |
| connector base (interface) | DIN 45326, 8 pin |
| front (optics) | glass |

ambient conditions

| | |
|-----------------------|--------------|
| operating temperature | 0 ... +50 °C |
| protection class | IP 54 |

order reference

| order reference | output circuit |
|-------------------|----------------|
| FLDM 170C1011/S42 | opto isolated |
| FLDM 170G1011/S42 | push-pull |



connection diagrams

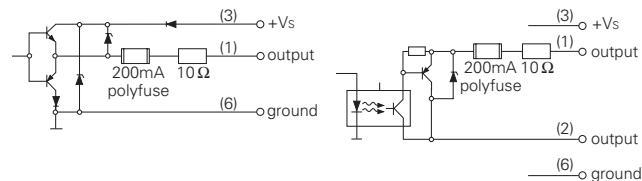

accessories

| | |
|--|--------|
| ScaDiag kit diagnostic program includes interface converter and manual | 156490 |
| mounting plate for mounting on rails | 157472 |
| for details, see accessories section | |

laser warning



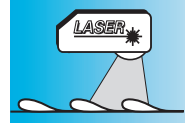

pin assignments

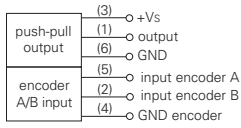

main connector push-pull

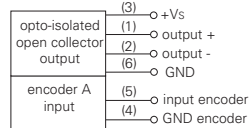

main connector open collector

connectors

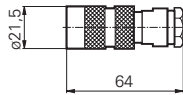

104236 6 pin (included)

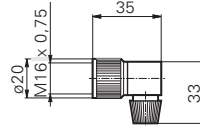

153094 6 pin (optional)

reflectors

FTDF 025F025 tape 25 x 25 mm
(included)

dimension drawing

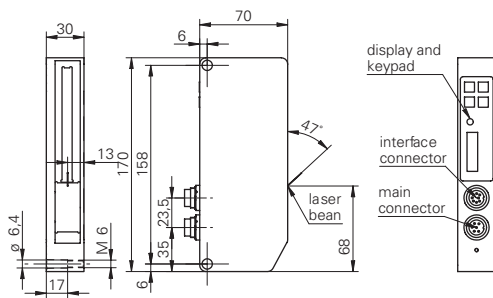

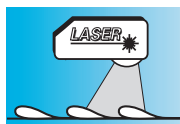

Sd = 0 ... 60 mm

- counting of up to 600'000 copies/hour
- standard connector M12x1
- compact design



general data

| | |
|----------------------------|---------------------------------------|
| measuring distance Sd | 0 ... 60 mm |
| optimum operating distance | 40 mm |
| counting rate | < 600'000 copies/h |
| object speed | < 5 m/sec |
| object cycle distance | > 1 mm |
| sensitivity | single sheet/edge thickness 0,2 mm |
| sync. input | no |
| measuring point | visible red laser line 2 mm |
| light source | pulsed red laser diode |
| wave length | 670 nm |
| laser class | 2 |
| edge indicator | LED yellow |
| power on indication | LED green |
| false pulse suppression | on/off switchable |

electrical data

| | |
|-----------------------------|--------------------------------|
| voltage supply range +Vs | 10 ... 30 VDC |
| current consumption max. | 180 mA |
| output pulse length | 5 / 10 / 15 / 20 ms selectable |
| short circuit protection | yes |
| reverse polarity protection | yes |

mechanical data

| | |
|------------------|-------------|
| type | rectangular |
| housing material | PA 6 |
| front (optics) | glass |

ambient conditions

| | |
|-----------------------|--------------|
| operating temperature | 0 ... +50 °C |
| protection class | IP 54 |

connection diagrams

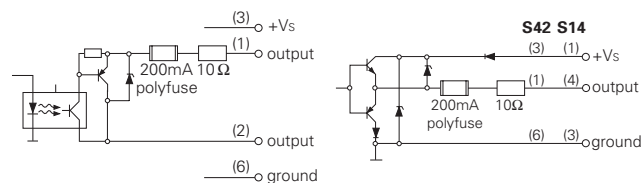

accessories

| | |
|--|--------|
| ScaDiag kit (M12 x 1) diagnostic program includes interface converter and manual | 156479 |
| ScaDiag kit (DIN 45322) diagnostic program includes interface converter and manual | 156489 |

for details, see accessories section

laser warning



| order reference | output circuit | connector base (main connector) |
|-------------------|----------------|---------------------------------|
| FLDK 110C1003/S42 | opto isolated | DIN 45322, 6 pin |
| FLDK 110G1003/S14 | push-pull | M12 x 1, 4 pin |
| FLDK 110G1003/S42 | push-pull | DIN 45322, 6 pin |

FLDK 110 Sd = 0 ... 60 mm

Laser copy counter SCATEC-2

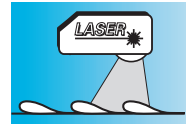

connectors

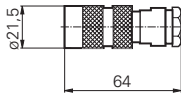

104236 6 pin DIN 45322
(included)

connectors M12 x 1

| | | |
|--------------|-------|----------------|
| ESG 34AH0200 | 4 pin | 2 m, straight |
| ESG 34AH0500 | 4 pin | 5 m, straight |
| ESG 34AH1000 | 4 pin | 10 m, straight |

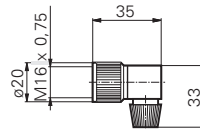

153094 6 pin DIN 45322
(optional)

connectors M12 x 1

| | | |
|--------------|-------|---------------|
| ESW 34AH0200 | 4 pin | 2 m, angular |
| ESW 34AH0500 | 4 pin | 5 m, angular |
| ESW 34AH1000 | 4 pin | 10 m, angular |

dimension drawings

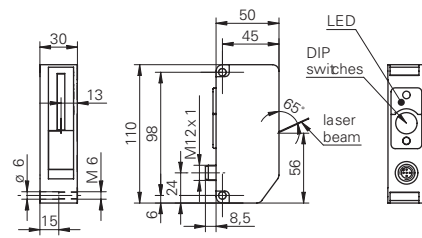
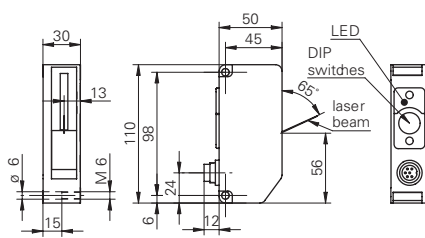

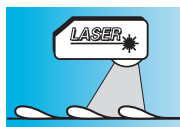

Sd = 0 ... 55 mm

- Plug & Play
- counting of up to 280'000 copies/hour
- compact design



general data

| | |
|----------------------------|---------------------------------------|
| measuring distance Sd | 0 ... 55 mm |
| optimum operating distance | 40 mm |
| counting rate | < 280'000 copies/h |
| object speed | < 2 m/sec |
| object cycle distance | > 13 mm |
| sensitivity | single sheet/edge thickness 1,5 mm |
| sync. input | no |
| measuring point | visible red point |
| light source | pulsed red laser diode |
| wave length | 670 nm |
| laser class | 2 |
| edge indicator | LED yellow |
| power on indication | LED green |
| sensitivity adjustment | no |

electrical data

| | |
|-----------------------------|---------------|
| voltage supply range +Vs | 10 ... 30 VDC |
| current consumption max. | 180 mA |
| output circuit | push-pull |
| output pulse length | 10 ms |
| short circuit protection | yes |
| reverse polarity protection | yes |

mechanical data

| | |
|---------------------------------|----------------|
| type | rectangular |
| housing material | PA 6 |
| connector base (main connector) | M12 x 1, 4 pin |
| front (optics) | glass |

ambient conditions

| | |
|-----------------------|--------------|
| operating temperature | 0 ... +50 °C |
| protection class | IP 54 |

order reference

FLDK 110G1010/S14

connection diagram

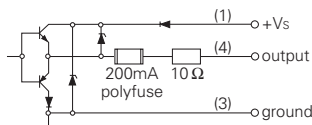

laser warning

CAUTION

LASER RADIATION

DO NOT STARE
INTO BEAM

LASERDIODE

Wavelength: 630 - 680 nm
Max. Output: < 1 mW
Complies with EN60825-1:2001

Class 2 LASER Product

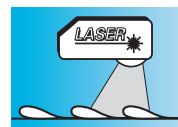

connectors

connectors M12 x 1

| | | |
|--------------|-------|----------------|
| ESG 34AH0200 | 4 pin | 2 m, straight |
| ESG 34AH0500 | 4 pin | 5 m, straight |
| ESG 34AH1000 | 4 pin | 10 m, straight |



connectors M12 x 1

| | | |
|--------------|-------|---------------|
| ESW 34AH0200 | 4 pin | 2 m, angular |
| ESW 34AH0500 | 4 pin | 5 m, angular |
| ESW 34AH1000 | 4 pin | 10 m, angular |

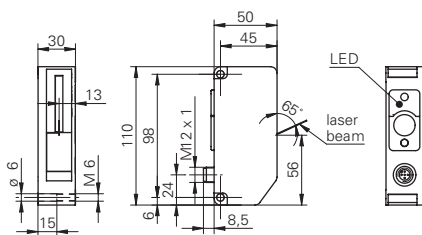
dimension drawing





| product family | FCDM 012 | FCDM 082 |
|---------------------------|---|--|
| |  |  |
| | <i>SpiderScan</i> | <i>SpiderScan</i> |
| width | 12 mm | 82 mm |
| actual range Sb | < 4 m | < 6,5 m |
| measuring field size | 150 mm | < 1677,5 mm |
| beam distance | 50 mm | 2,5 mm |
| resolution | 50 mm | 2,5 mm |
| switching output | ■ | - |
| switching output + RS 422 | ■ | - |
| RS 422 | - | ■ |
| SSI + RS 422 | - | ■ |
| parallel 10 Bit + RS 422 | - | ■ |
| Page | 534 | 536 |



General information

The light barriers are electronic infrared light curtains to detect objects or for continuous measuring purposes. Light barriers are available with a measuring field of up to 1,6 m, a measuring distance of up to 6,5 m and a resolution of 1,25 mm to 50 mm.

Applications

- Automatic measurement of large objects such as parcels or crates on a conveyor belt.
- Use as area/object size/object position monitor, e.g. in front of the compartment door of automatic spray painting machines
- Ejection monitoring of punching machines

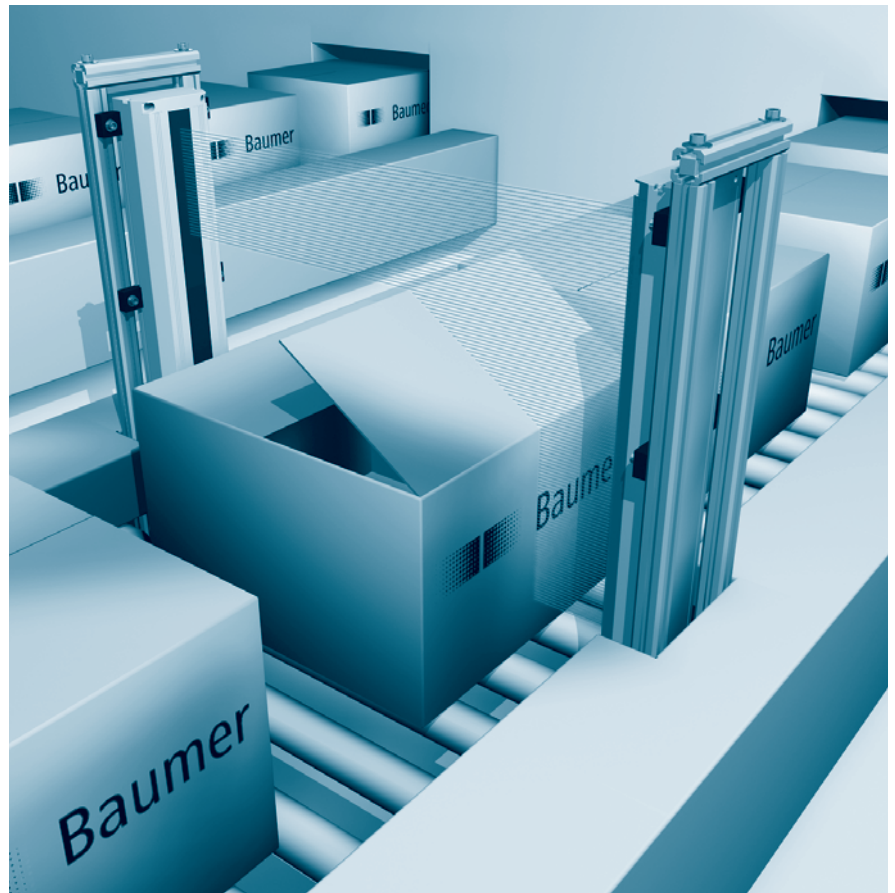



Characteristics and advantages

- **High cycle rate**
Due to the high clock frequency of the system (100 kHz), very fast measurements are achieved, which ensures the highest measuring accuracy even with quickly moving objects.
Example: a light barrier with 96 beams requires less than 1.2 ms for a measuring cycle, or the measuring cycle is < 0.1 ms with a light barrier with 4 beams.
- **Reliable measuring principle**
As the individual light beams are aligned parallel to each other, it is irrelevant to the measurement results whether the measured object is closer to the receiver or closer to the emitter.
- **Simple installation**
As only the receiver associated with each emitter diode is activated, a wide-angled beam from the emitter is possible. This light beam ensures that the light barrier operates faultlessly even under heavy vibrations. An LED integrated in the receiver unit which immediately indicates all interruptions of the beam channel is a valuable aid for adjusting the light barrier.
- **Integrated processing**
Due to the compact construction, it is possible to integrate the processing and interface electronics in the light barrier, making an external processing unit unnecessary. This substantially simplifies installation and wiring.
- **Rugged housing**
Both the emitter and the receiver are installed in an aluminum housing. The design of this housing takes account not only of ruggedness, but also a means of simple installation.
- **Multi-system operation**
The light barrier FCDM 082 is equipped to make it possible to synchronize several measuring systems with each other. This prevents several systems operating on one measurement from interfering with each other.
- **Parameter setting software**
With the *SpiderView* software, the parameters of the light barriers can be set via an RS 422 interface. The software is written for Windows 95/98/2000/XP.

Technology and operation

Each measuring system consists of an emitter and a receiver unit, each containing a micro-controller to control the light pulses. During a measuring cycle, the individual emitting diodes are activated in sequence and the corresponding receiver unit is simultaneously scanned. This means that the first sensor is interrupted at the precise time when the imaginary line from the first emitter to the first receiver is interrupted. This applies equivalently to the next beams, forming a "light barrier" of parallel light beams. During each measuring cycle, the number of interrupted beams is determined. The value is issued as "DATA" and the position of the first interrupted beam is available as the "POSITION" value.

Output formats:

DATA/POSITION "normal"

The system issues the number of interrupted beams as "DATA" and the position of the first interrupted beam as "POSITION".

DATA/POSITION „largest blocked area“

The system issues the largest blocked area as "DATA" and the number of the beam at which this area begins as "POSITION".



Technology and operation

DATA/POSITION „over all“

The system issues the number of beams between the first and last interrupted beam as “DATA” and the position of the first interrupted beam as “POSITION”.

Double scanning:

For various applications, higher measuring accuracy and improved object detection are required. The double scanning function is available for this purpose. An additional diagonal beam is inserted between the parallel beams. This produces twice the resolution at the middle of the measuring distance.

Smoothing:

With the “smoothing” function, the number of interrupted beams from which a measurement is made is determined. Measuring beams are thereby only regarded as interrupted if the number of immediately adjacent interrupted measuring beams is at least equal to the “smoothing” value. In units with RS 422 interfaces, this value can be adjusted. Otherwise, this function is inactive and unavailable.

Interfaces:

Parallel

Parallel output of the number of interrupted beams as a 10-bit binary value. Whether DATA or POSITION is issued as the value can be chosen via a control line.

Example: in a light barrier with 32 measuring beams, an object interrupts the first 15 measuring beams. The first four of the six PNP switch elements are therefore closed (000001111).

RS 422

The RS 422 interface permits the connection of the light barrier to a subsidiary controller. Apart from reading the measured data, numerous adjustments can be made to the system via the interface.

Transistor switching output

If a beam (or a number of beams determined by the smoothing value) is interrupted, the output switches.

SSI (synchronous serial interface)

With the SSI interface, the data is transmitted in Gray code with a clock frequency of 100 kHz.

Mounting and adjustment

The emitter and receiver should be as parallel as possible to each other and be installed at the same height to ensure the optimum function and receiver excess gain.

Due to the diverging angle of radiation of the IR diodes (which has advantages for installation), reflective surfaces in close proximity with the light barrier can deflect the light sufficiently to result in incorrect information.

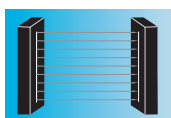

Sb = 4 m

- very small housing 12 mm
- 100 kHz high clock frequency
- aluminum housing material rugged

**general data**

| | |
|----------------------|----------------|
| measuring field | 150 mm |
| actual range Sb | < 4 m |
| beam distance | 50 mm |
| resolution | 50 mm |
| number of beams | 4 |
| alignment aid | LED green |
| light source | infrared diode |
| wave length | 950 nm |
| clock frequency | 91 kHz |
| clock speed per beam | 11 µs |
| analysis time | 150 µs |

electrical data

| | |
|-----------------------------|--------------|
| voltage supply range +Vs | 24 VDC ± 10% |
| residual ripple | < 200 mV |
| current consumption max. | 500 mA |
| short circuit protection | yes |
| reverse polarity protection | yes |

mechanical data

| | |
|------------------|-------------|
| width / diameter | 12 mm |
| height / length | 252 mm |
| depth | 40 mm |
| type | rectangular |
| housing material | aluminum |

ambient conditions

| | |
|-----------------------|----------------------------|
| operating temperature | -25 ... +55 °C |
| humidity | 0 ... 90 % (non condensed) |
| protection class | IP 65 |

cable

included in delivery:
 power/data cable length 3 m
 synchronization cable length 5 m
 specify other lengths when ordering

accessory

remote access kit:
 software "SpiderView",
 interface cable with converter,
 manual

| order reference | output circuit | output current | interface |
|--------------------|----------------|----------------|-----------|
| FCDM 012P0150/50.0 | PNP | < 100 mA | - |
| FCDM 012J0150/50.0 | - | - | RS 422 |

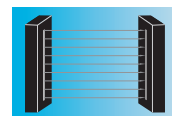

configuration

If a configuration different from the factory setting is desired, this must be specified in the order. Other settings can also be made with the programming kit. In this case, it is essential that a version with RS 422 interface is ordered.

| | factory setup | optional |
|-----------------|---------------|--|
| data format | normal | "largest blocked area" oder "over all" |
| actual range | 1,2 ... 2 m | ... m (min. 0,5 m/max. 4 m) |
| double scanning | no | yes |
| smoothing data | 1 beam | number of beams |

dimension drawing

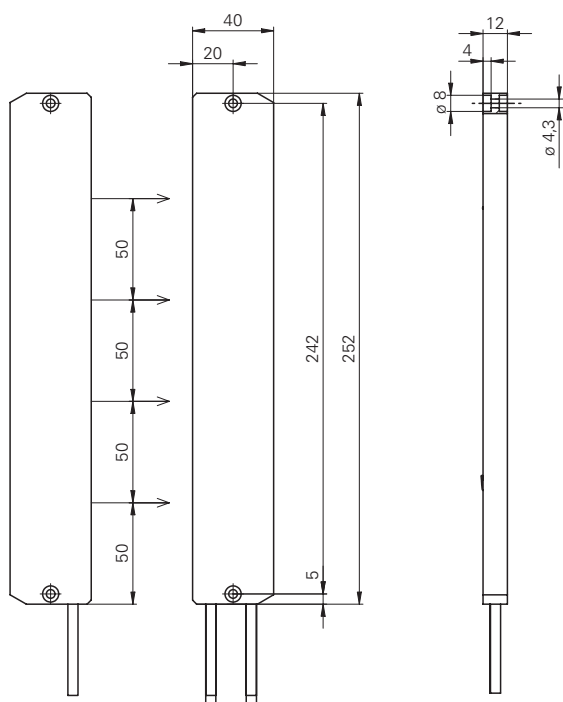

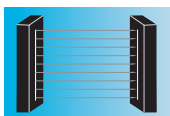

Sb = 6,5 m



- high resolution
- 100 kHz high clock frequency
- rugged aluminum housing material

general data

| | |
|----------------------|---------------------|
| measuring field | 237,5 ... 1677,5 mm |
| actual range Sb | < 6,5 m |
| beam distance | 2,5 mm |
| resolution | 2,5 mm |
| number of beams | 96 ... 672 |
| alignment aid | LED green |
| light source | infrared diode |
| wave length | 950 nm |
| clock frequency | 100 kHz |
| clock speed per beam | 10 µs |
| analysis time | 200 µs |

electrical data

| | |
|-----------------------------|--------------|
| voltage supply range +Vs | 24 VDC ± 10% |
| residual ripple | < 200 mV |
| current consumption max. | 1,2 A |
| short circuit protection | yes |
| reverse polarity protection | yes |

mechanical data

| | |
|------------------|-------------|
| width / diameter | 82 mm |
| depth | 40 mm |
| type | rectangular |
| housing material | aluminum |

ambient conditions

| | |
|-----------------------|----------------------------|
| operating temperature | -25 ... +55 °C |
| humidity | 0 ... 90 % (non condensed) |
| protection class | IP 65 |

cable

included in delivery:
 synchronization cable length 5 m
 connector 7 pin
 connector RS-422
 other connectors, interfaces and cable lengths on request

accessory

remote access kit: 163150
 software "SpiderView",
 interface cable with converter,
 manual

| order reference | number of beams | measuring field Lm | height/length L | L1 |
|--------------------|-----------------|--------------------|-----------------|----------|
| FCDM 082x0237/02.5 | 96 | 237,5 mm | 390 mm | 128,5 mm |
| FCDM 082x0477/02.5 | 192 | 477,5 mm | 630 mm | 128,5 mm |
| FCDM 082x0717/02.5 | 288 | 717,5 mm | 870 mm | 128,5 mm |
| FCDM 082x0957/02.5 | 384 | 957,5 mm | 1110 mm | 128,5 mm |
| FCDM 082x1197/02.5 | 480 | 1197,5 mm | 1350 mm | 128,5 mm |
| FCDM 082x1437/02.5 | 576 | 1437,5 mm | 1590 mm | 128,5 mm |
| FCDM 082x1677/02.5 | 672 | 1677,5 mm | 1830 mm | 128,5 mm |

interface

- J RS 422
- I SSI + RS 422
- B Parallel 10 Bit + RS 422

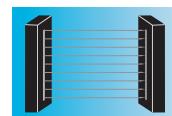

configuration

If a configuration different from the factory setting is desired, this must be specified in the order. Other settings can also be made with the programming kit.

| | factory setup | optional |
|-----------------|-----------------|--------------------------------------|
| data format | normal | "largest blocked area" or "over all" |
| actual range | 0,6 ... 1 m | ... m (min. 0,2 m / max. 6,5 m) |
| output mode | number of beams | mm |
| coding | binary | «Gray» or «BCD» |
| double scanning | no | yes |
| smoothing data | 1 beam | ... beams |

mounting

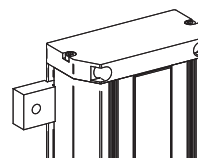

groove plate

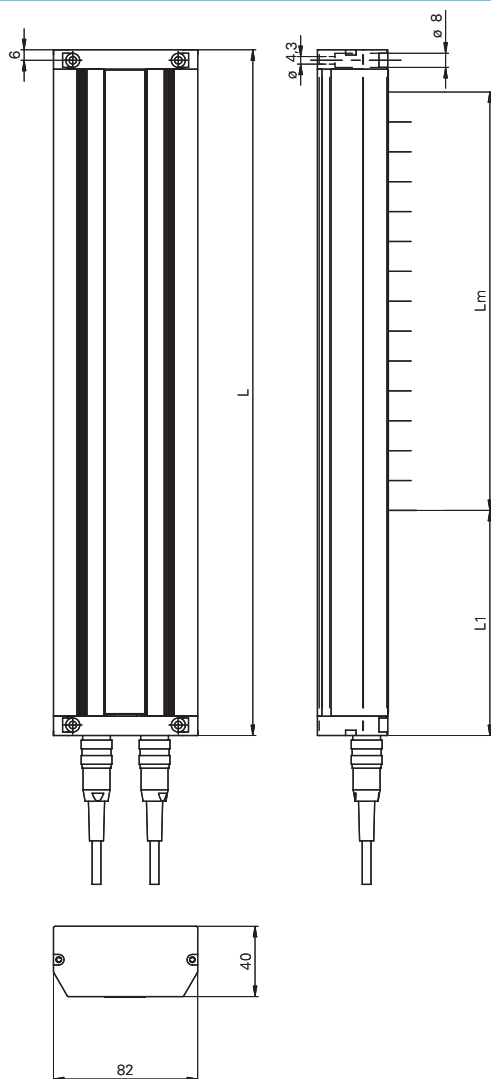

part nr. 161963

dimension drawing



Color/Contrast recognition



| product family | FKDM 22 | FKDM 22 | FKDM 22 |
|------------------------------|---|---|--|
| |  |  |  |
| | <i>LOGIPAL</i> | <i>LOGIPAL</i> | <i>LOGIPAL</i> |
| sensing distance T_w | 40 mm | 40 mm | 25 mm |
| sensor channels | 4 (teachable) | 2 (teachable) | 4 (teachable) |
| size of measuring spot | 3 mm x 5 mm | 3 mm x 5 mm | 0,7 mm x 1,3 mm |
| response time / release time | < 0,34 ms | < 0,34 ms | < 0,34 ms |
| NPN | ■ | ■ | ■ |
| PNP | ■ | ■ | ■ |
| device plug | rotatable by 180° | rotatable by 180° | rotatable by 180° |
| housing material | metal | metal | metal |
| Page | 542 | 543 | 544 |



General information

With the **LOGIPAL** color detection sensor, you can now use the color as a solution for sorting, quality monitoring and automation in your processes.

Applications

- Products marked with colored marks can be monitored and sorted.
- The correct color of objects can be inspected or the objects can be sorted by their color.

Characteristics and advantages

- **Simple operation:**
Four different colors can be programmed with just three buttons.
- **Finest color graduation:**
One of five tolerance stages can be chosen for each color.
- **Short response time:**
With a response time of only 0,34 ms, high detection rates can be achieved.
- **Synchronization input:**
Permits controlled measurement of the color.
- **External Teach-in input:**
Permits complete remote control of all teach-in functions by serial data transfer. An RS 232 interface transducer with galvanic isolation is available as an accessory.

Technology and operation

The sensor operates by the three-stage principle, meaning that it emits the three colors red, green and blue and then measures the color proportions of the three colors reflected by the object.

The color of an object is programmed in the teach-in procedure. If the sensor recognizes this color again during operation, it activates the corresponding output. Optional tolerances permit it to detect large or small differences in color.

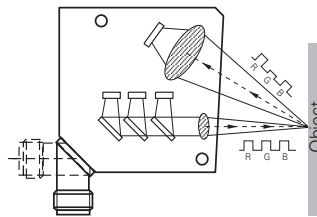

Mounting and adjustment

The use of the color sensor is as simple as for a diffuse sensor. Only the points below must be observed.

- For glossy objects, tilt the sensor to the side by approx. 15 °.
- If you wish to detect very fine differences in color, the sensing distance of 40 mm must be complied with as closely as possible.

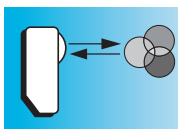

Tw = 40 mm



- up to 4 colors can be distinguished properly
- spot size 3 x 5 mm
- rugged metal housing

general data

| | |
|------------------------|-------------------------|
| sensing distance Tw | 40 mm |
| sensor channels | 4 (teachable) |
| tolerance ranges | 5-step teachable (LEDs) |
| size of measuring spot | 3 mm x 5 mm |
| light source | LED red / green / blue |
| signal display (Teach) | LED orange |
| channel status display | LED yellow per channel |
| power on indication | LED green |

electrical data

| | |
|------------------------------|--|
| response time / release time | < 0,34 ms |
| voltage supply range +Vs | 10 ... 30 VDC |
| power consumption | < 2 W |
| voltage drop Vd | < 1,8 VDC |
| output current (per channel) | < 100 mA |
| remote Teach-In input | protocol with return signal through channel 1-output |
| level (sync., teach) | high: 2/3 Vs...Vs low: 0 V...1/3 Vs |
| short circuit protection | yes |
| reverse polarity protection | yes |

mechanical data

| | |
|------------------|-------------------|
| type | rectangular |
| housing material | die-cast zinc |
| front (optics) | glass |
| device plug | rotatable by 180° |

ambient conditions

| | |
|-----------------------|----------------|
| operating temperature | -10 ... +55 °C |
| protection class | IP 67 |

connectors

| | | |
|---------------|-------|-------------------------|
| ESG 34FP0200B | 8 pin | 2 m straight (shielded) |
|---------------|-------|-------------------------|

additional cable connectors and field wireable connectors, see accessories

accessories

| | |
|------------------|--------|
| mounting bracket | 126220 |
|------------------|--------|

for details, see accessories section

dimension drawing

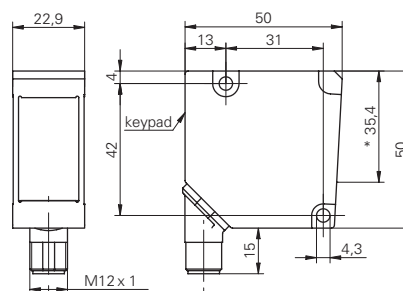

* emitter axis

connection diagrams

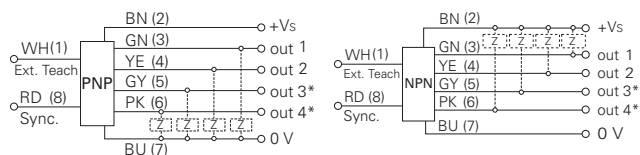

* only in the 4-channel version

* only in the 4-channel version

| order reference | output circuit | output function | sync. input |
|-------------------|----------------|-----------------|-------------|
| FKDM 22N1901/S14F | NPN | light operate | high active |
| FKDM 22P1901/S14F | PNP | light operate | low active |
| FKDM 22P3901/S14F | PNP | dark operate | low active |

FKDM 22 Tw = 40 mm

Color sensors LOGIPAL

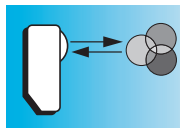

Tw = 40 mm

- up to 2 colors can be distinguished properly
- spot size 3 x 5 mm
- rugged metal housing



general data

| | |
|------------------------|-------------------------|
| sensing distance Tw | 40 mm |
| sensor channels | 2 (teachable) |
| tolerance ranges | 5-step teachable (LEDs) |
| size of measuring spot | 3 mm x 5 mm |
| light source | LED red / green / blue |
| signal display (Teach) | LED orange |
| channel status display | LED yellow per channel |
| power on indication | LED green |

electrical data

| | |
|------------------------------|--|
| response time / release time | < 0,34 ms |
| voltage supply range +Vs | 10 ... 30 VDC |
| power consumption | < 2 W |
| voltage drop Vd | < 1,8 VDC |
| output current (per channel) | < 100 mA |
| remote Teach-In input | protocol with return signal through channel 1-output |
| level (sync., teach) | high: 2/3 Vs...Vs low: 0 V...1/3 Vs |
| short circuit protection | yes |
| reverse polarity protection | yes |

mechanical data

| | |
|------------------|-------------------|
| type | rectangular |
| housing material | die-cast zinc |
| front (optics) | glass |
| device plug | rotatable by 180° |

ambient conditions

| | |
|-----------------------|----------------|
| operating temperature | -10 ... +55 °C |
| protection class | IP 67 |

connectors

| | | |
|---------------|-------|-------------------------|
| ESG 34FP0200B | 8 pin | 2 m straight (shielded) |
|---------------|-------|-------------------------|

additional cable connectors and field wireable connectors, see accessories

accessories

| | |
|------------------|--------|
| mounting bracket | 126220 |
|------------------|--------|

for details, see accessories section

dimension drawing

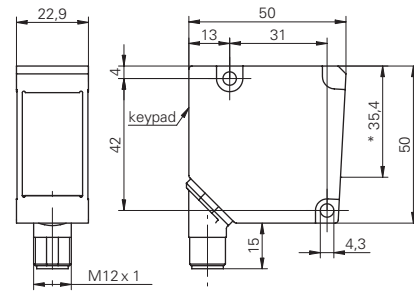

* emitter axis

connection diagrams

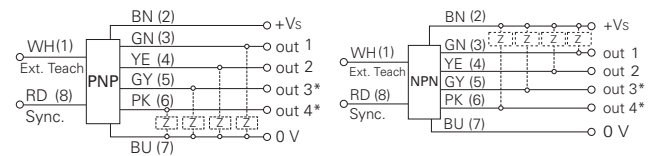

* only in the 4-channel version

* only in the 4-channel version

| order reference | output circuit | output function | sync. input |
|-------------------|----------------|-----------------|-------------|
| FKDM 22N1902/S14F | NPN | light operate | high active |
| FKDM 22P1902/S14F | PNP | light operate | low active |
| FKDM 22P3902/S14F | PNP | dark operate | low active |

FKDM 22 Tw = 40 mm

Color sensors LOGIPAL

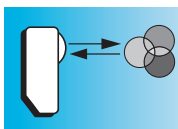

Tw = 25 mm

- up to 4 colors can be distinguished properly
- spot size 0,7 x 1,3 mm
- rugged metal housing



general data

| | |
|------------------------|-------------------------|
| sensing distance Tw | 25 mm |
| sensor channels | 4 (teachable) |
| tolerance ranges | 5-step teachable (LEDs) |
| size of measuring spot | 0,7 mm x 1,3 mm |
| light source | LED red / green / blue |
| signal display (Teach) | LED orange |
| channel status display | LED yellow per channel |
| power on indication | LED green |

electrical data

| | |
|------------------------------|--|
| response time / release time | < 0,34 ms |
| voltage supply range +Vs | 10 ... 30 VDC |
| power consumption | < 2 W |
| output function | light operate |
| voltage drop Vd | < 1,8 VDC |
| output current (per channel) | < 100 mA |
| remote Teach-In input | protocol with return signal through channel 1-output |
| level (sync., teach) | high: 2/3 Vs...Vs low: 0 V...1/3 Vs |
| short circuit protection | yes |
| reverse polarity protection | yes |

mechanical data

| | |
|------------------|-------------------|
| type | rectangular |
| housing material | aluminum anodized |
| front (optics) | glass |
| device plug | rotatable by 180° |

ambient conditions

| | |
|-----------------------|----------------|
| operating temperature | -10 ... +55 °C |
| protection class | IP 67 |

connectors

| | | |
|---------------|-------|-------------------------|
| ESG 34FP0200B | 8 pin | 2 m straight (shielded) |
|---------------|-------|-------------------------|

additional cable connectors and field wireable connectors, see accessories

accessories

| | |
|------------------|--------|
| mounting bracket | 126220 |
|------------------|--------|

for details, see accessories section

dimension drawing

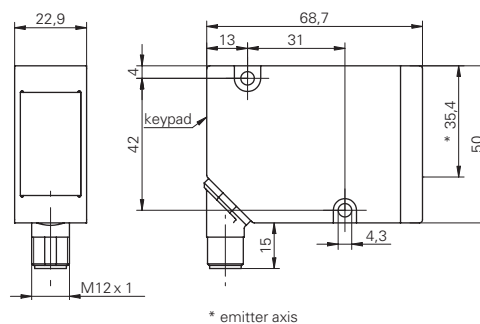

connection diagrams

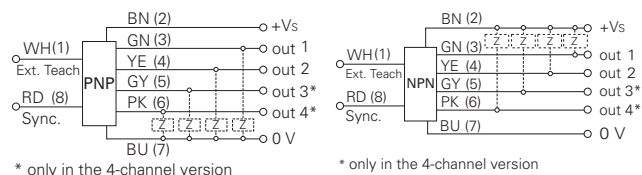





| order reference | output circuit | sync. input |
|-------------------|----------------|-------------|
| FKDM 22N1911/S14F | NPN | high active |
| FKDM 22P1911/S14F | PNP | low active |

FKDM 22 Tw = 25 mm

Color sensors LOGIPAL



| product family | OZDK 10 | OZDK 10 | OZDK 14 | OZDM 16 | OZDM 16 |
|------------------------------|---|---|---|---|---|
| |  |  |  |  |  |
| width / diameter | 10,4 mm | 10,4 mm | 14,8 mm | 15,4 mm | 15,4 mm |
| sensing distance Tw | 3 ... 150 mm | 3 ... 150 mm | 20 ... 300 mm | 0 ... 250 mm | 0 ... 250 mm |
| response time / release time | < 0,05 ms | < 0,05 ms | < 0,15 ms | < 0,05 ms | < 0,1 ms |
| sensitivity adjustment | Pot, 5 turn | Pot, 5 turn | teach-in | Pot, 14 turn | Pot, 14 turn |
| NPN | ■ | ■ | ■ | ■ | |
| PNP | ■ | ■ | ■ | ■ | ■ |
| cable | ■ | ■ | | ■ | ■ |
| connector | ■ | ■ | ■ | ■ | ■ |
| housing material | plastic | plastic | plastic | metal | metal |
| Page | 548 | 550 | 552 | 554 | 556 |



General information

This diffuse laser sensor permits the finest differences in contrast to be detected. Due to the very small light spot, the sensor can precisely detect such states down to a size of 0,1 mm.

Applications

- **Registration:**
Printed marks on objects used to align the printing mechanism or trigger an event.
- **Indentations, grooves, edges:**
If a surface is observed from an oblique angle, the reflection behavior changes at an indentation, which is equivalent to a change in contrast for the sensor.
- **Analog output:**
This makes it possible to read the desired nominal values and to detect deviations from these.

Characteristics and advantages

- **Red laser light:**
Easily visible measuring spot.
- **Adjustable laser spot size:**
Very small diameter due to focused laser beam.
- **Fast reaction time:**
Reaction times of down to 0,1 ms.
- **Low laser class:**
No problems in use.
- **Switching output:**
For simpler sensing problems.
- **Switching output:**
With high linearity with regard to brightness.

Technology and operation

This sensor is based on the intensity difference principle with a clearly defined, small light spot (laser). At the ideal working distance, it is optimized so that contrasts are detected almost independently of small changes in the distance ("plateau" in the signal curve). The sensor issues a signal proportional to the brightness with good linearity for all matt objects (= linear range) at the analog output. Glossy objects up to reflective sheet metal are also detected. This is due to a deliberate non-linearity with regard to the brightness with a strong receiving signal.

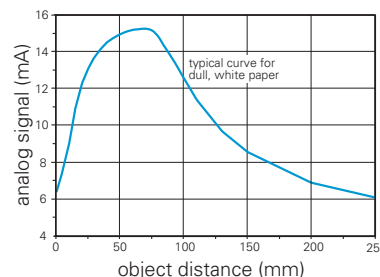

Mounting and adjustment

The sensor should normally be installed tilted by 5° to 20° to the object surface, particularly if glossy materials are scanned.

If edges, grooves or indentations are scanned, the sensor must be aimed so that the direct reflection is detected when the indentation, groove or edge enters the light beam.

The working distance must be adjusted according to the measuring task:

- Scanning at the laser focus permits positioning with high accuracy.
- With a light spot approx. 1 mm in size, small differences in contrast are detected even with slight surface roughness and non-homogenous colors.

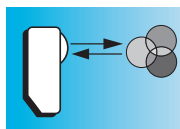

Tw = 3 ... 150 mm

- subminiature housing
- high repeatability
- very short response time



general data

| | |
|---|-------------------------|
| type | diffuse contrast sensor |
| light source | pulsed red laser diode |
| sensing distance Tw | 3 ... 150 mm |
| optimum operating distance | 20 ... 40 mm |
| detectable remission difference (on grey) | > 8 % |
| repeatability | < 0,2 mm at laser focus |
| light indicator | LED yellow |
| power on indication | LED green |
| sensitivity adjustment | Pot, 5 turn |
| laser class | 2 |
| distance to laser focus | 40 mm |
| wave length | 675 nm |

electrical data

| | |
|------------------------------|----------------------|
| response time / release time | < 0,05 ms |
| voltage supply range +Vs | 10 ... 30 VDC |
| current consumption max. | 50 mA |
| current consumption typ. | 40 mA |
| voltage drop Vd | < 1,8 VDC |
| output function | light / dark operate |
| output current | < 100 mA |
| short circuit protection | yes |
| reverse polarity protection | yes |

mechanical data

| | |
|------------------|---------------|
| width / diameter | 10,4 mm |
| height / length | 27 mm |
| depth | 16,3 mm |
| type | rectangular |
| housing material | plastic (ASA) |
| front (optics) | PMMA |

ambient conditions

| | |
|-----------------------|----------------|
| operating temperature | -10 ... +50 °C |
|-----------------------|----------------|

connection diagrams



connectors

| | | |
|--------------|-------|--------------|
| ESG 32AH0200 | 4 pin | 2 m straight |
| ESW 31AH0200 | 4 pin | 2 m angular |

additional cable connectors and field wireable connectors, see accessories

accessories

| | |
|-----------------------------------|--------|
| SENSOFIX mounting kit | 150326 |
| mounting bracket (cable type) | 114501 |
| mounting bracket (connector type) | 133792 |

for details, see accessories section

laser warning



| order reference | connection types | output circuit | protection class |
|-------------------|---------------------|----------------|------------------|
| OZDK 10N5101 | cable 4 pin | NPN | IP 65 |
| OZDK 10N5101/S35A | connector M8, 4 pin | NPN | IP 67 |
| OZDK 10P5101 | cable 4 pin | PNP | IP 65 |
| OZDK 10P5101/S35A | connector M8, 4 pin | PNP | IP 67 |

OZDK 10 Tw = 3 ... 150 mm Diffuse laser sensors for contrast detection

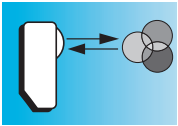

Tw = 3 ... 150 mm

- subminiature housing
- high repeatability
- very short response time



general data

| | |
|----------------------------|-------------------------|
| type | diffuse contrast sensor |
| version | line beam |
| light source | pulsed red laser diode |
| sensing distance Tw | 3 ... 150 mm |
| optimum operating distance | 35 ... 45 mm |
| repeatability | < 0,2 mm at laser focus |
| light indicator | LED yellow |
| power on indication | LED green |
| sensitivity adjustment | Pot, 5 turn |
| laser class | 2 |
| distance to laser focus | 40 mm |
| wave length | 675 nm |

electrical data

| | |
|------------------------------|----------------------|
| response time / release time | < 0,05 ms |
| voltage supply range +Vs | 10 ... 30 VDC |
| current consumption max. | 50 mA |
| current consumption typ. | 40 mA |
| voltage drop Vd | < 1,8 VDC |
| output function | light / dark operate |
| output current | < 100 mA |
| short circuit protection | yes |
| reverse polarity protection | yes |

mechanical data

| | |
|------------------|---------------|
| width / diameter | 10,4 mm |
| height / length | 27 mm |
| depth | 16,3 mm |
| type | rectangular |
| housing material | plastic (ASA) |
| front (optics) | PMMA |

ambient conditions

| | |
|-----------------------|----------------|
| operating temperature | -10 ... +50 °C |
|-----------------------|----------------|

connection diagrams



connectors

| | | |
|--------------|-------|--------------|
| ESG 32AH0200 | 4 pin | 2 m straight |
| ESW 31AH0200 | 4 pin | 2 m angular |

additional cable connectors and field wireable connectors, see accessories

accessories

| | |
|-----------------------------------|--------|
| SENSOFIX mounting kit | 150326 |
| mounting bracket (cable type) | 114501 |
| mounting bracket (connector type) | 133792 |

for details, see accessories section

laser warning

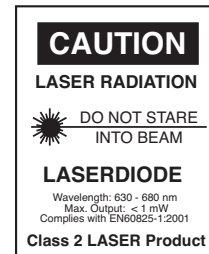

| order reference | connection types | output circuit | protection class |
|-------------------|---------------------|----------------|------------------|
| OZDK 10N5150 | cable 4 pin | NPN | IP 65 |
| OZDK 10N5150/S35A | connector M8, 4 pin | NPN | IP 67 |
| OZDK 10P5150 | cable 4 pin | PNP | IP 65 |
| OZDK 10P5150/S35A | connector M8, 4 pin | PNP | IP 67 |

OZDK 10 Tw = 3 ... 150 mm

Diffuse laser sensors for contrast detection

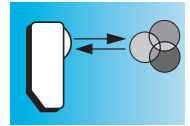

relative receiving signal

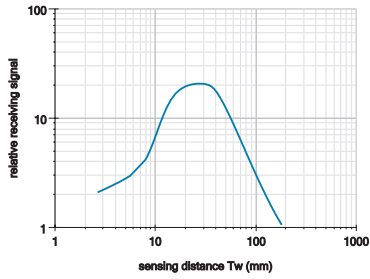

beam characteristic

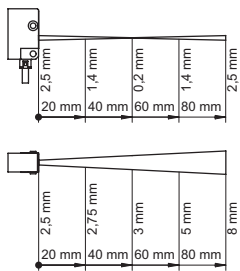

dimension drawings

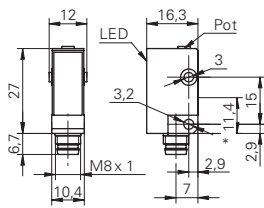

* emitter axis

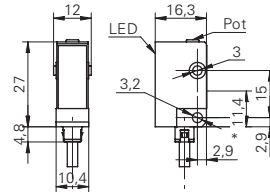

* emitter axis

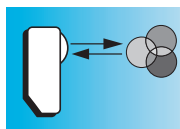

Tw = 20 ... 300 mm

- very short response time
- high repeatability
- sensing distance adjustable via Teach-in



general data

| | |
|-----------------------------------|--------------------------|
| type | diffuse contrast sensor |
| light source | pulsed red laser diode |
| sensing distance Tw | 20 ... 300 mm |
| repeatability | < 0,2 mm at laser focus |
| alignment / soiled lens indicator | flashing light indicator |
| light indicator | LED yellow |
| power on indication | LED green |
| sensitivity adjustment | Teach-in |
| laser class | 2 |
| distance to laser focus | 115 mm |
| wave length | 650 nm |

electrical data

| | |
|------------------------------|---------------|
| response time / release time | < 0,15 ms |
| voltage supply range +Vs | 10 ... 30 VDC |
| current consumption max. | 35 mA |
| current consumption typ. | 25 mA |
| voltage drop Vd | < 2,2 VDC |
| output function | light operate |
| output current | < 100 mA |
| short circuit protection | yes |
| reverse polarity protection | yes |

mechanical data

| | |
|------------------|---------------------|
| width / diameter | 14,8 mm |
| height / length | 43 mm |
| depth | 31 mm |
| type | rectangular |
| housing material | plastic (PA12) |
| front (optics) | PMMA |
| connection types | connector M8, 4 pin |

ambient conditions

| | |
|-----------------------|----------------|
| operating temperature | -10 ... +50 °C |
| protection class | IP 67 |

order reference output circuit

| | |
|-------------------|-----|
| OZDK 14N1901/S35A | NPN |
| OZDK 14P1901/S35A | PNP |

connection diagrams



connectors

| | | |
|--------------|-------|--------------|
| ESG 32AH0200 | 4 pin | 2 m straight |
| ESW 31AH0200 | 4 pin | 2 m angular |

additional cable connectors and field wireable connectors, see accessories

accessories

| | |
|-----------------------|--------|
| SENSOFIX mounting kit | 149011 |
| mounting bracket | 134964 |

for details, see accessories section

laser warning

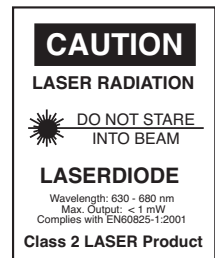

OZDK 14 Tw = 20 ... 300 mm Diffuse laser sensors for contrast detection

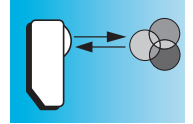

relative receiving signal

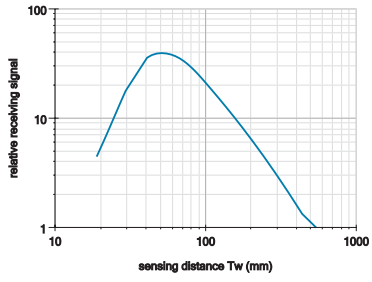

beam characteristic

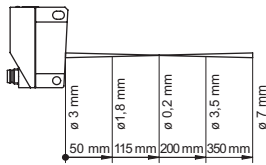

dimension drawing

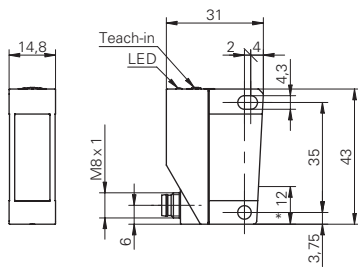

* emitter axis

OZDK 14 $T_w = 20 \dots 300$ mm

Diffuse laser sensors for contrast detection

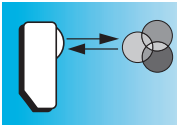

Tw = 0 ... 250 mm

- rugged metal housing
- high repeatability
- very short response time



general data

| | |
|---|-------------------------|
| type | diffuse contrast sensor |
| light source | pulsed red laser diode |
| sensing distance Tw | 0 ... 250 mm |
| optimum operating distance | 40 ... 80 mm |
| detectable remission difference (on grey) | > 8 % |
| repeatability | < 0,1 mm at laser focus |
| output indicator | LED yellow |
| sensitivity adjustment | Pot, 14 turn |
| laser class | 2 |
| distance to laser focus | 80 mm |
| wave length | 675 nm |

electrical data

| | |
|------------------------------|---------------|
| response time / release time | < 0,05 ms |
| voltage supply range +Vs | 12 ... 30 VDC |
| current consumption max. | 65 mA |
| current consumption typ. | 60 mA |
| voltage drop Vd | < 1,8 VDC |
| output current | < 200 mA |
| short circuit protection | yes |
| reverse polarity protection | yes |

mechanical data

| | |
|------------------|---------------|
| width / diameter | 15,4 mm |
| height / length | 50 mm |
| depth | 50 mm |
| type | rectangular |
| housing material | die-cast zinc |
| front (optics) | glass |

ambient conditions

| | |
|-----------------------|----------------|
| operating temperature | -10 ... +50 °C |
| protection class | IP 67 |

connection diagrams

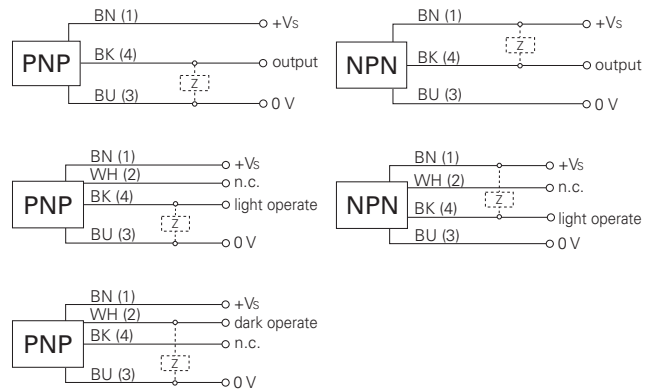

connectors

| | | |
|--------------|-------|--------------|
| ESG 34AH0200 | 4 pin | 2 m straight |
| ESW 33AH0200 | 4 pin | 2 m angular |

additional cable connectors and field wireable connectors, see accessories

accessories

| | |
|-----------------------|--------|
| SENSOFIX mounting kit | 151721 |
| mounting bracket | 113917 |

for details, see accessories section

laser warning



| order reference | connection types | output circuit | output function |
|------------------|----------------------|----------------|-----------------|
| OZDM 16N1001 | cable 3 pin | NPN | light operate |
| OZDM 16N1001/S14 | connector M12, 4 pin | NPN | light operate |
| OZDM 16P1001 | cable 3 pin | PNP | light operate |
| OZDM 16P1001/S14 | connector M12, 4 pin | PNP | light operate |
| OZDM 16P3001 | cable 3 pin | PNP | dark operate |
| OZDM 16P3001/S14 | connector M12, 4 pin | PNP | dark operate |

OZDM 16 Tw = 0 ... 250 mm Diffuse laser sensors for contrast detection

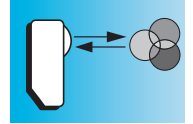

relative receiving signal

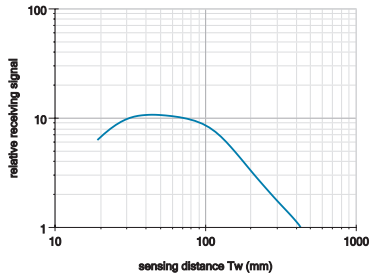

beam characteristic

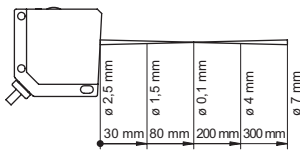

dimension drawings

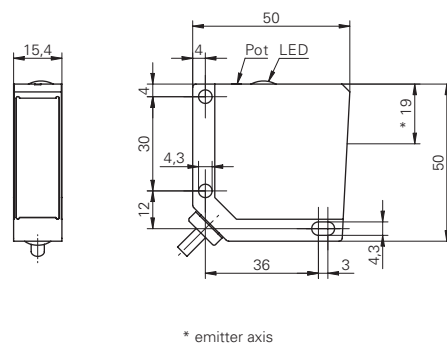
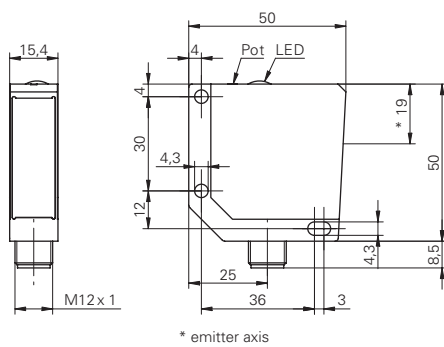

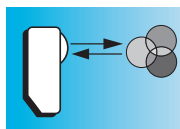

Tw = 0 ... 250 mm

- with analog output
- high repeatability
- very short response time



general data

| | |
|---|-------------------------|
| type | diffuse contrast sensor |
| light source | pulsed red laser diode |
| sensing distance Tw | 0 ... 250 mm |
| optimum operating distance | 40 ... 80 mm |
| detectable remission difference (on grey) | > 8 % |
| repeatability | < 0,1 mm at laser focus |
| output indicator | LED yellow |
| sensitivity adjustment | Pot, 14 turn |
| laser class | 2 |
| distance to laser focus | 80 mm |
| wave length | 675 nm |

electrical data

| | |
|------------------------------|--------------------------|
| response time / release time | < 0,1 ms |
| voltage supply range +Vs | 12 ... 30 VDC |
| current consumption max. | 65 mA |
| current consumption typ. | 60 mA |
| voltage drop Vd | < 1,8 VDC |
| output function | light operate |
| output circuit | PNP / analog 4 ... 20 mA |
| output current | < 200 mA |
| short circuit protection | yes |
| reverse polarity protection | yes |

mechanical data

| | |
|------------------|---------------|
| width / diameter | 15,4 mm |
| height / length | 50 mm |
| depth | 50 mm |
| type | rectangular |
| housing material | die-cast zinc |
| front (optics) | glass |

ambient conditions

| | |
|-----------------------|----------------|
| operating temperature | -10 ... +50 °C |
| protection class | IP 67 |

order reference **connection types**

| | |
|-------------------------|----------------------|
| OZDM 16P1901 | cable 4 pin |
| OZDM 16P1901/S14 | connector M12, 4 pin |

connection diagram

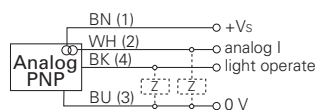

connectors

| | | |
|--------------|-------|--------------|
| ESG 34AH0200 | 4 pin | 2 m straight |
| ESW 33AH0200 | 4 pin | 2 m angular |

additional cable connectors and field wireable connectors, see accessories

accessories

| | |
|-----------------------|--------|
| SENSOFIX mounting kit | 151721 |
| mounting bracket | 113917 |

for details, see accessories section

laser warning



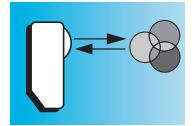

signal progression

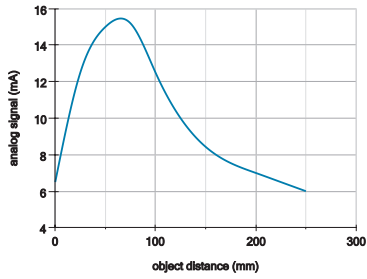

beam characteristic

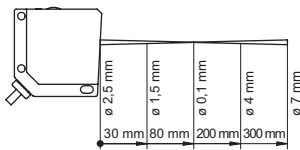

dimension drawings

